



Klohn Crippen Berger

Teck Metals Ltd

Sullivan Mine Tailings Facilities

2017 Dam Safety Inspection

R2



A05807A17

ISO 9001
ISO 14001
OHSAS 18001

March 2018

March 28, 2018

Teck Metals Ltd.
Bag 2000
Kimberley, British Columbia
V1A 3E1

Ms. Kathleen Willman
Manager, Engineering and Remediation

Dear Ms. Willman:

Sullivan Mine Tailings Facilities
2017 Dam Safety Inspection – R2

Klohn Crippen Berger is pleased to submit a copy of the “2017 Dam Safety Inspection Report” for Teck Metal’s Sullivan Mine located in Kimberley, British Columbia. This report documents our visual observations of the existing conditions of the Sullivan Mine tailings dikes and our review of the instrumentation data to August 31, 2017. The reporting period for the 2017 DSI is from September 1, 2016 through August 31, 2017.

We appreciate the opportunity to continue to provide our services to Teck Metals. Please call the undersigned at (403) 730-6815 if you have any questions.

Yours truly,
KLOHN CRIPPEN BERGER LTD.

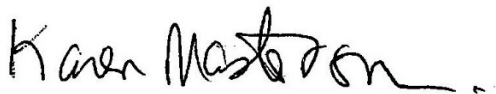

Karen Masterson, M.E.Sc., P.Eng.
Project Manager

KM:ro

Teck Metals Ltd

Sullivan Mine Tailings Facilities

2017 Dam Safety Inspection

R2

EXECUTIVE SUMMARY

This report presents the 2017 Annual Dam Safety Inspection (DSI) of the tailings dikes and dams at Sullivan Mine located in Kimberley, British Columbia. The 2017 DSI is the 26th consecutive annual inspection of the dikes and dams at the facility carried out by Klohn Crippen Berger Ltd. (KCB), formerly Klohn Crippen Consultants Ltd.

The report presents the findings from the site visit by the Engineer of Record, Ms. Karen Masterson, P.Eng., on May 10 and 11, 2017, as well as a review of the instrumentation data collected and routine work performed at Sullivan Mine between September 1, 2016 and August 31, 2017. The routine work included:

- Regular maintenance activities, which includes grading of access roads, cleaning of ditches and removal of shrubs;
- Ongoing review of ARD storage and stormwater management capacities – KCB is assisting Teck with this work. Included is a review and update of the surface hydrology including inflow design flood (IDF) and Probable Maximum Flood (PMF). KCB submitted two reports in 2017 in relation to this work: one assessing the feasibility of increasing ARD storage and one reviewing sludge deposition in the ARD Pond; and,
- Updates to the Operations, Maintenance and Surveillance Manual and Emergency Preparedness and Response Plan – these routine updates are ongoing.

Summary of Facility Description

After almost a century of operations the Sullivan Mine was closed at the end of 2001. Reclamation work on the tailings areas started in 1990, and was essentially completed by 2008.

There is a total of 15 earthfill dams and dike structures that create 7 separate storage facilities for tailings, ARD water, and sludge. A summary of the size and lengths for each facility is shown below. The earthfill structures have a combined length of 10.4 km, with maximum heights varying from 4.2 m to 29 m.

While many of these facilities were initially designed and constructed through the 1970's and 80's or earlier, field investigations and design reviews (stability assessments) have been completed since that time. To enhance stability, modifications to the structures included flattening of slopes and/or construction of toe berms such that the structures meet or exceed required factors of safety under static and dynamic loading, considering the Maximum Credible Earthquake and assuming all tailings liquefy. Most recently, two Dam Safety Reviews were completed in 2008 and 2013, which included reviews of dam/dike stability against current criteria, and have determined that the dams/dikes are stable.

Summary of Storage Facilities at Sullivan Mine

| Storage Facility | Embankment | Type | Approximate Embankment Length (m) | Approximate Maximum Height (m) | Starter Dike Constructed (Year) ¹ | Year of Last Dike Raise (Year) |
|------------------------------------|----------------------|-----------------------|-----------------------------------|--------------------------------|--|--------------------------------|
| Iron Pond (Emergency Storage Pond) | Iron Dike | Iron Tailings | 1500 | 29.0 | 1975 | 1999 |
| Old Iron Pond | Southwest Limb | Iron Tailings | 520 | 7.6 | Unknown | Unknown |
| | Southeast Limb | Iron Tailings | 1190 | 2-3 ³ | Unknown | Unknown |
| Siliceous Ponds | No. 1 Siliceous Dike | Silica Tailings | 2000 | 7.6 ³ | 1923 | 1979 |
| | No. 2 Siliceous Dike | Silica Tailings | 730 | 9.5 | 1975 | 1982 |
| | No. 3 Siliceous Dike | Silica Tailings | 1540 | 12.5 | 1975 | 1984 |
| Gypsum Ponds | East Gypsum Dike | Gypsum | 670 | 16.8 | 1969 | 1983 |
| | West Gypsum Dike | Gypsum | 640 | 22.9 | 1969 | 1986 |
| | Northeast Dike | Gypsum, Seepage Water | 120 | 10.0 | 1985 | 1985 |
| | Recycle Pond | Seepage/ARD Water | 90 | 6.0 | 1985 | 1985 |
| Calcine Pond | Calcine Dike | Calcine | 520 | 4.6 ³ | 1972 | 1986 |
| ARD Pond (see note 2) | North Dam | ARD/Seepage Water | 460 | 7.6 | 2001 | 2001 |
| | South Dam | ARD/Seepage Water | 330 | 16.8 | 1976 | 2001 |
| Sludge Pond | North Dike | Sludge | 120 | 4.3 | 1978 | 1978 |
| | South Dike | Sludge | 200 | 6.1 | 1978 | 1978 |

Notes:

1. Starter Dike information based on data from Annual Inspection Report by SRK-Robinson dated June 1991.
2. The ARD Pond is established at the site of the old cooling pond.
3. Tailings were placed downstream of both Southeast Limb and Siliceous Pond #1 Dikes. The original height of the Southeast Limb and Siliceous Pond #1 Dike from original ground is 10.7 m and 16.8 m, respectively. A municipal landfill is downstream from the Calcine Pond Dike. The height of the Calcine Dike from original ground is 15.2 m...

Summary of Key Hazards and Consequences

As a required component of a dam safety inspection, the key potential hazards and failure modes have been identified. The key hazards for the storage facilities at Sullivan Mine are overtopping during major flood events for all ponds and piping failures at the ARD Pond, Iron Pond (ESP). Other hazards such as earthquake, slope instability and foundation failure are not considered “key hazards” and are discussed in the main text of the report.

The likelihood of overtopping failures is close to non-credible¹ to very rare² given the closure measures in place (e.g. drainage channels, spillways, etc. designed for PMF/PMP) for the Old Iron, Siliceous, Gypsum and Calcine Ponds. Spillways designed for the PMF/PMP are also in place for the ARD Pond and Iron Pond (ESP) such that the likelihood of overtopping is close to non-credible. The likelihood of failure for overtopping of the sludge pond is unlikely³ based on the review of the storage capacity completed in 2015⁴.

The likelihood for piping failures (ARD Pond and Iron Pond (ESP)) is also close to non-credible to very rare given the filter zones within the ARD Pond Dams and the low pond water levels and associated piezometric surfaces within the Iron Pond (ESP). The likelihood of a piping failure for the sludge pond is rare⁵ given the filter zone along the upstream face and lack of permanent pond. In addition, Teck has a robust surveillance program to monitor pond levels and check for dike surface gulying that might lead to freeboard changes, and to look for any evidence of changes in seepage conditions at the toe of each dike that could indicate potential piping (ARD Pond, Iron Dike (ESP) and Sludge Pond).

¹ “Close to Non-Credible” Likelihood Rating is defined as: for a natural hazard (earthquake, flood, windstorm, etc.), the predicted return period for an event of this strength/magnitude is greater than 1 in 10,000 years; this rating is also applicable for failure modes such as instability and internal erosion. Factor of safety (FoS) for slope instability of 2.0 or greater.

² “Very Rare” is defined as: for a natural hazard (earthquake, flood, windstorm, etc.), the predicted return period for an event of this strength/magnitude is between 1 in 1,000 and 1 in 10,000 years; this rating is also applicable for failure modes such as instability and internal erosion. Factor of safety (FoS) against slope instability of 1.5 to 2.0.

³ “Unlikely” is defined as: for a natural hazard (earthquake, flood, windstorm, etc.), the predicted return period for an event of this strength/magnitude is between 1 in 10 and 1 in 100 years; this rating is also applicable for failure modes such as instability and internal erosion. Factor of safety (FoS) against slope instability of 1.2 to 1.3.

⁴ Sludge pond capacity to be reviewed based on recent changes to HSRC inflow design flood requirements.

⁵ “Rare” Likelihood Rating is defined as: for a natural hazard (earthquake, flood, windstorm, etc.), the predicted return period for an event of this strength/magnitude is between 1 in 100 years and 1 in 1000 years; this rating is also applicable for failure modes such as instability and internal erosion. Factor of safety (FoS) against slope instability of 1.3 to 1.5

Consequence Classifications (CDA and HSRC)

Consequence classification is not related to the likelihood of a failure, but rather the potential impact resulting from a failure if it did occur. A review of the consequence classification according to 2007 CDA guidelines (CDA, 2013) was undertaken as part of the 2008 Dam Safety Review (KCB, 2009) and the 2013 Dam Safety Review (Golder, 2014), and based on the information available, consequence classifications of the seven storage facilities were determined as summarized below:

Tailings Dikes and Consequence Classification

| Storage Facility | Embankment | Consequence Classification |
|------------------|-----------------------------|----------------------------|
| Iron Pond (ESP) | Iron Dike | H |
| Old Iron Pond | Southwest Limb | L |
| | Southeast Limb | L |
| Siliceous Ponds | No. 1 Siliceous Dike | L |
| | No. 2 Siliceous Dike | L |
| | No. 3 Siliceous Dike | L |
| Gypsum Ponds | East Gypsum Dike | H |
| | West Gypsum Dike | H |
| | North East Gypsum Pond Dike | L |
| | Recycle Pond | L |
| Calcine Pond | Calcine Dike | L |
| Sludge Pond | North Dike | L |
| | South Dike | L |
| ARD Pond | North Dam | VH |
| | South Dam | VH |

Notes:

1. Consequence Categories based on 2007 Canadian Dam Safety Guidelines (CDA, 2013): E=Extreme, VH= Very High, H=High, S=Significant, L=Low.

There have been no changes to the consequences of failure to warrant a change to the current dam classification at this time.

However, it is important to highlight that, while all of these structures are currently considered “dams” from a regulatory perspective, few of the inactive facilities are retaining fluid tailings and could be considered equivalent to earthen landfills. This is evident through a review of the instrumentation data which indicates piezometric surfaces for most which are very low (i.e. near original ground or 1 – 2 m above), especially for the Southeast and Southwest Limbs of the Old Iron Pond, the Siliceous Ponds, the Calcine Pond and the Gypsum Ponds. In such cases, their respective

consequence classifications could be significantly lowered and, eventually, it may be possible to declassify some of these dikes in the near future. Teck and KCB are in the process of developing a phased work plan to support lowering the consequence classifications for some of the inactive facilities and towards eventual declassification of the dikes where considered feasible and appropriate.

Summary of Key Observations (Instrumentation and Visual)

Iron Pond Dike

Based on the visual observations and instrumentation review, the stability of the Iron Dike is considered satisfactory. The spillway from the Iron Pond (ESP) is in good condition.

Of the 30 piezometers installed within the Iron Pond Dike, 22 indicated an increase in the pore pressure in 2017 over last year's readings due to higher than average precipitation. However, all readings were below the threshold levels and well below piezometric levels assumed for design stability assessments. Two of the piezometers (P92-H and P92-25) are installed within the confined aquifer below the dike. These piezometers indicated stable piezometric levels during 2017.

There was essentially no measurable settlement recorded by the settlement plates in 2017. There has been between 30 to 65 mm of settlement since 2007, which is below the threshold values. The survey of the dike crest adjacent to the spillway indicated that the crest is at or above the design elevation of 1042 m.

At Station 5+00 there is seepage from the Iron Pond that collects in the drainage ditch at the dike toe. The ditch connects to the main collector ditch along the west side of the West Gypsum Pond. The flow rates within the ditches are recorded by two weirs (Weir #3- AIPWU and Weir #4). Weir #3 (AIPWU), which was installed in 2013 and is located 25 m from the dike, recorded a minimum flow rate of 0.07 m³/day during March, and a peak flow rate of 61.3 m³/day during April. The peak flow rates recorded during this reporting period were the highest since installation of the new weir, in response to above average precipitation and snowpack during the reporting period. Due to the location of the weir, the peak recorded flow will include runoff from the dike and surrounding area. A peak flow of 688.5 m³/day was recorded during the same month at Weir #4. As this weir is 300 m from the dike, the flow rate includes run-off from the surrounding terrain as well as any seepage collected. Although the peak flow recorded for Weir #4 is significantly higher than in previous years, it is still below the maximum recorded flow that occurred in March of 2012 during a period of high precipitation. Seepage also collects in a pond near the dike toe at station 24+00, which should be observed during site inspections.

Old Iron Pond Dike

The instrumentation and visual inspection indicate the Southeast and Southwest Limbs of the Old Iron Dike are in good physical condition and performing as intended. Three of the four active piezometers installed within the Southwest Limb recorded maximum pore pressures above the threshold levels, but subsequent readings have indicated a reduction of piezometric levels below threshold levels. Both of the active piezometers located within the Southeast Limb are currently

below their threshold levels. The increases were due to the higher than average precipitation (rainfall and snowpack) in 2017.

It was recommended in the 2016 DSI that piezometer P96-11 be replaced as it could not be read in 2008/2009 nor in 2013 and recent readings had been erratic. As this dike is a low consequence structure and pump 940 continues to collect seepage from the Old Iron Pond maintaining low piezometric levels, it is recommended that the piezometer be installed by the end of Q3 2018. Additionally, it is recommended that piezometer P96-08 be replaced as the tip elevation is unknown and only relative changes in pore pressures are recorded. The recent readings have also been erratic.

Siliceous Pond Dikes

The instrumentation data and visual inspections indicate that the Siliceous Pond Dikes #1, #2 and #3, the surface water division channel, and rip-rapped emergency spillway are in good condition. The dikes are performing as intended.

Of the 12 piezometers installed within the Siliceous Pond Dikes, two instruments (P105 and P301) recorded maximum readings above their threshold levels. A subsequent reading for P301 indicated that the high reading was most likely an error as it indicated a piezometric level similar to previous readings. The threshold level for P105 will be reviewed in 2018 to assess if it is appropriate as the threshold is below the piezometric level assumed for design.

It is recommended that three piezometers, P301, P302 and P303 be replaced in 2018 due to sediment build-up in the standpipes and to more accurately ascertain the piezometric level within the pond.

Gypsum Pond Dikes

The instrumentation data and visual inspections indicate that both the East and West Gypsum Dikes are in good physical condition and performing as intended. There were indications of rodent activity at the toes of the dikes, which is not considered a dam safety issue. The burrows were filled in and the areas will continue to be monitored during subsequent inspections. Visual observations of seepage indicate similar flows as previous years and no indication of sediments.

Piezometer readings show that the water levels in 2017 remain low within both the West and East Gypsum Dikes, with all instruments showing steady or decreasing trends.

The three settlement plates and Sondex gauge at the West Gypsum Dike are settling between 10 to 40 mm/year, with rates decreasing in 2017 as stabilization continues. The general mode of deformation shows ongoing settlement with a slight rotation of the crest upstream into the pond. The two active settlement plates and Sondex Gauge in the East Gypsum Dike continue to settle at a uniform rate of approximately 15 mm/year to 30 mm/year. The horizontal displacements are occurring at a rate of approximately 10 mm/year, and are directed upstream, perpendicular to the dike crest. The rates of settlement are below the threshold levels, settlement is expected to continue, and is not a dam safety concern.

Northeast Gypsum Dike and Recycle Dam

The visual inspection indicates the structures to be in good physical condition and performing as intended. Following the recommendations of the 2004 DSI report, piezometric readings are no longer required for dam safety purposes. The two settlement plates indicate no measurable settlement since 2007.

North and South Dams of the ARD Pond

Based on a review of the instrumentation data for the North and South Dams of the ARD Pond and the results of the visual inspection, the dams are in good physical condition and are performing as intended. A buildup of algae was observed in the ditch south of the South Dam during the 2017 site inspection, potentially impacting flow of seepage in the ditch and affecting the readings from Weir #1 (ARDWU). The algae was cleared in the fall of 2016 following KCB's site visit, but the build-up was again noticed during the 2017 site visit and has since been cleared out. Of the eight piezometers installed within the North Dam, one (ND-02S) recorded a maximum pore pressure reading above the threshold level in early spring. Three piezometers within the South Dam (PP01-06, SD-02, and SD-03) also recorded maximum pore pressures above the threshold levels during the early spring. The threshold levels were exceeded for one reading and subsequent readings decreased to levels below the thresholds following spring runoff. The increased pore pressures were expected as precipitation (rainfall and snowpack) were higher than average. The piezometric levels above the thresholds are not a dam safety concern as the piezometric surfaces were below those assumed for design and the design factors of safety are well above minimum requirements, indicating the pore pressures measured in 2017 did not affect dam stability. A review of the thresholds will be completed in 2018 such that the thresholds will incorporate years of higher than average precipitation. Many of the standpipe piezometers located along or near the North and South Dams continue to show a direct response to changes in the reservoir elevation.

Two weirs (Weir #1 – ARDWU and Weir #2) are located at the South Dam to record seepage flows, although runoff from the dikes and surrounding terrain is also captured. The peak measured flows for the reporting period were 202.0 m³/day and 241.2 m³/day, respectively. The highest flows were recorded when the pond elevation was above 1040 m, and coincide with the spring melt and rainfall in March and April. This is consistent with historical trends. The lowest flows are encountered in July when pond levels are low, after the water collected in the pond has been pumped to the water treatment plant and there is lower precipitation.

Calcine Pond

There were no changes observed during the site inspection and the visual observations indicated the dike is performing as intended.

North and South Dikes of the Sludge Pond

The North and South Dikes of the Sludge Pond were observed to be in good physical condition. Surveys of the South and North Dike crests conducted in 2016 and 2017 indicated that the south end of the South crest is lower than required at the access ramp and the east end of the North Dike crest

was narrower than the design minimum. Grading work was completed in Fall 2017 at the North Dike access ramp such that the crest width is now per design and no further work is required regarding this issue. An assessment of the effect of the lower crest at the South Dike will be completed as part of the geotechnical review and capacity assessment to be completed in 2018 as noted below.

At the time of closure, a review of the geotechnical design for the sludge pond dikes was not completed as there was minimal sludge retained and the risk and consequences of failure were low. There is still minimal sludge deposited against the South Dike, however, the sludge at the North Dike is at the assumed design level. A review of the stability of the dikes is recommended. A review of the sludge pond capacity was completed in 2015. It was estimated that the sludge pond could accommodate another 15 to 20 years of operation. However, with the recent changes to the HSRC requirements (MEMPR, 2017), the design flood event required for the sludge pond has increased and a review is required to assess if the current design freeboard is adequate to accommodate the new required design flood event of 1/3 between 1/975 year event and PMF.

Summary of Significant Changes

There are no significant changes to report with regards to dam stability for all dikes/dams. As the mine is a closed facility and the ponds and dikes have undergone reclamation, there are no annual operations activities other than ongoing care and maintenance.

Summary of Review of OMS & EPRP Manuals

The Operation, Maintenance and Surveillance (OMS) Manual for the Sullivan Mine Tailings Facilities was updated in April 2016, which included changes as recommended in the 2016 DSI.

Additional updates are currently in progress for both the OMS Manual and Emergency Preparedness and Response Procedures Manual.

Summary of Deficiencies and Non-conformances

Recommendations arising from the 2017 inspection are summarized below along with completed recommendations from 2016.

Closed, Outstanding and New Recommendations

| Structure | No. | Description | Applicable Regulation or OMS Reference | Recommended Action | Priority | Recommended Deadline /Status |
|--------------------|---------|---|---|---|----------|--|
| Closed | | | | | | |
| Iron Pond | 2016-4 | Dike crest elevation adjacent to the ESP | OMS Section 5.0 | Recommend survey of the Iron Dike Crest between Stations 0+00 and 14+00 to determine if crest is at design elevation. | 3 | CLOSED–Completed May 2017. Dike is at or above El. 1042 m. |
| Outstanding | | | | | | |
| ALL | 2016-1 | OMS Manual requires updates | MEMPR HSRC (2017) & CDA Guidelines: Application to Mining Dams (2014) | Additional information to be added in 2017. EPRP Section to be removed once separate document completed. | 4 | Q4 2018 |
| ALL | 2016-2 | EPR Plan requires updates | MEMPR HSRC (2017) & CDA Guidelines: Application to Mining Dams (2014) | Update EPR Plan such that it follows Teck's Tailings Guidelines and MEM's HSRC (2016a). Currently no mention of potential inundation/flood hazard. | 4 | Q4 2018 |
| Old Iron Pond | 2016-3 | Southwest Limb piezometer P96-11 readings are erratic and unreliable. | OMS Section 4.0 | Recommend replacement of P96-11 (improperly labelled P91-11 in 2016 DSI) with a new piezometer near the toe of the 2007 buttress to monitor piezometric levels at the toe. | 4 | Q3 2018 |
| New | | | | | | |
| Old Iron Pond | 2017-01 | Southwest Limb piezometer P96-08 only records relative piezometric levels as tip elevation is unknown. | OMS Section 4.0 | P96-08 should be replaced as the tip elevation is unknown and the readings only provide relative change in elevation. This instrument will provide additional information regarding piezometric levels near the crest of the dike. | 4 | Q3 2018 |
| Siliceous Ponds | 2017-02 | Siliceous Dike #3 standpipe piezometers P301, 302 and 303 contain significant sediment, which was not removed during flushing in 2014. The bottom depths of these piezometers are now at or just above the phreatic surface assumed for design. | OMS Section 4.0 | These piezometers should be replaced such that the tips are near the base of the tailings to monitor the phreatic surface within the pond. | 4 | Q3 2018 |
| Sludge Pond | 2017-03 | Changes to HSRC design flood requirements indicate a review of the sludge pond hydrology is needed. | MEMPR HSRC (2017) & CDA Guidelines: Application to Mining Dams (2014) | Review of the current design freeboard and design sludge levels is required for the new design flood event of 1/3 between 1/975 year event and PMF (HSRC 2016). To facilitate the design update, the sludge pond surface should be surveyed to obtain average sludge deposition rates. This design review should include recommendations for addressing the low crest location at the South Dike. | 3 | Q4 2018 |

The priority ranking for outstanding and new recommendations is defined as follows:

Priority Description

- 1 A high probability or actual dam safety issue considered immediately dangerous to life, health or the environment, or a significant risk of regulatory enforcement.
- 2 If not corrected could likely result in dam safety issues leading to injury, environmental impact or significant regulatory enforcement; or, a repetitive deficiency that demonstrates a systematic breakdown of procedures.
- 3 Single occurrence of deficiencies or non-conformances that alone would not be expected to result in dam safety issues.
- 4 Best Management Practice – Further improvements are necessary to meet industry best practices or reduce potential risks.

Date of Next DSR

The most recent Dam Safety Review (DSR) was undertaken by Golder Associates in 2013. The report recommended that Very High consequence structures have a DSR every five years and High consequence structures every seven years. The next DSR for the ARD Pond Dams, Iron Pond Dike and East and West Gypsum Pond Dikes is scheduled for 2018 with all structures combined into one DSR. Additionally, the Siliceous Pond Dikes, Calcine Pond Dike, and Old Iron Pond Dike will be included in the DSR. This is consistent with the revised MEMPR Health, Safety and Reclamation Code Regulations that require DSR's to be conducted every five years regardless of consequence classification. This is also in compliance with the 2007 CDA Guidelines (CDA, 2013) for Very High consequence structures.

TABLE OF CONTENTS

| | |
|--|-----------|
| EXECUTIVE SUMMARY..... | I |
| 1 INTRODUCTION..... | 1 |
| 1.1 Purpose, Scope of Work and Methodology..... | 1 |
| 1.2 Regulatory Requirements..... | 1 |
| 1.2.1 Mines Act and HSRC..... | 1 |
| 1.2.2 Water Act and BC Dam Safety Regulation..... | 2 |
| 1.2.3 Permits and Licences | 2 |
| 1.3 Facility Description | 3 |
| 1.4 Background Information and History | 5 |
| 1.4.1 Reference Reports | 6 |
| 1.4.2 Reference As-Built Drawings | 8 |
| 1.4.3 Units of Measure and Reference Coordinates | 10 |
| 2 CONSTRUCTION AND OPERATION DURING 2017 | 11 |
| 2.1 Tailings Deposition – Not Applicable | 11 |
| 2.2 Available Tailings Storage – Not Applicable | 11 |
| 2.3 Construction and Operations Activities (2017) | 11 |
| 2.4 Updated Cross Sections | 11 |
| 3 CLIMATE DATA AND WATER BALANCE DURING 2017..... | 12 |
| 3.1 Review and Summary of Climate Data | 12 |
| 3.1.1 Precipitation and Runoff..... | 12 |
| 3.1.2 Evaporation..... | 13 |
| 3.2 Review and Summary of Water Balance | 14 |
| 3.2.1 Area-Volume Curve..... | 14 |
| 3.2.2 Water Level Variation | 15 |
| 3.2.3 Inflows / Outflows | 15 |
| 3.3 Freeboard and Storage | 18 |
| 3.4 Water Discharge Volumes | 19 |
| 3.5 Water Discharge Quality..... | 19 |
| 4 SITE OBSERVATIONS | 20 |
| 4.1 Visual Observations | 20 |
| 4.2 Photographs..... | 22 |
| 4.3 Instrumentation Review | 23 |
| 4.3.1 Iron Pond Dike (ESP) | 23 |
| 4.3.2 Old Iron Pond Dikes | 24 |
| 4.3.3 No. 1, 2, and 3 Siliceous Pond Dike | 25 |

TABLE OF CONTENTS

(continued)

| | | |
|----------|---|-----------|
| 4.3.4 | West Gypsum Pond Dike | 26 |
| 4.3.5 | East Gypsum Pond Dike | 27 |
| 4.3.6 | Northeast Gypsum Dike and Recycle Dam | 28 |
| 4.3.7 | ARD Pond Dams | 29 |
| 4.3.8 | Calcine Pond Dike | 31 |
| 4.3.9 | Sludge Pond Dikes..... | 31 |
| 5 | DAM SAFETY ASSESSMENT | 33 |
| 5.1 | Design Basis Review..... | 33 |
| 5.1.1 | Geotechnical | 33 |
| 5.1.2 | Hydrology..... | 34 |
| 5.2 | Hazards and Failure Modes Review..... | 35 |
| 5.3 | Review of Downstream and Upstream Conditions | 36 |
| 5.4 | Dam Classification Review | 36 |
| 5.5 | Physical Performance | 37 |
| 5.5.1 | Geotechnical | 37 |
| 5.5.2 | Hydrotechnical..... | 38 |
| 5.5.3 | Hydrogeological – Not Applicable | 39 |
| 5.5.4 | Geochemical – Not Applicable..... | 39 |
| 5.5.5 | Mechanical and Structural – Not Applicable..... | 39 |
| 5.6 | OMS Manual | 39 |
| 5.7 | Emergency Preparedness & Response Review | 39 |
| 6 | SUMMARY AND RECOMMENDATIONS | 41 |
| 6.1 | Summary of Construction and Operation Activities..... | 41 |
| 6.2 | Summary of Climate and Water Balance..... | 41 |
| 6.3 | Summary of Performance..... | 41 |
| 6.4 | Summary of Changes to Facility | 43 |
| 6.5 | Consequence Classification | 43 |
| 6.6 | Table of Deficiencies and Non-conformances..... | 43 |
| 7 | CLOSURE | 45 |
| | REFERENCES..... | 46 |

TABLE OF CONTENTS

(continued)

List of Tables

| | | |
|-----------|--|-------------------------------------|
| Table 1.1 | Summary of Storage Facilities at Sullivan Mine | 4 |
| Table 1.2 | Historical Development | 6 |
| Table 1.3 | Summary of Drawings Prepared by TM Tech Services | 9 |
| Table 3.1 | ARD Pond: Precipitation Inflow | 13 |
| Table 3.2 | Lake Evaporation at Duncan Lake Dam Station (Source: Environment Canada) | 13 |
| Table 3.3 | ARD Pond: Monthly Water Balance Summary | 17 |
| Table 3.4 | Relevant ARD Pond Characteristics | 18 |
| Table 3.5 | Relevant ESP Characteristics..... | 19 |
| Table 3.6 | Summary of Discharge to St. Mary's River | 19 |
| Table 4.1 | Monitoring Frequencies for 2018..... | 32 |
| Table 5.1 | Hazards and Failure Modes | Error! Bookmark not defined. |
| Table 5.2 | Consequence Classification | 36 |
| Table 6.1 | Summary of Closed, Outstanding and New Recommendations | 44 |

List of Figures

| | |
|-----------|--|
| Figure 1 | Location and Site Plan |
| Figure 2 | Tailings Seepage Collection and the DWT Plant Location |
| Figure 3 | General Arrangements of Tailings Facilities |
| Figure 4 | Iron Pond Dike - Instrument Location Plan |
| Figure 5 | Iron Pond Dike - Typical Sections |
| Figure 6 | Old Iron Pond Dike - Instrument Location Plan |
| Figure 7 | Old Iron Pond Dike - Typical Section |
| Figure 8 | Siliceous Pond Dikes No 1, 2 & 3 - Instrument Location Plan |
| Figure 9 | Siliceous Pond Dikes No 1, 2 & 3 - Typical Sections |
| Figure 10 | West Gypsum Dike - Instrument Location Plan |
| Figure 11 | West Gypsum Dike - Typical Section |
| Figure 12 | East Gypsum Dike - Instrument Location Plan |
| Figure 13 | East Gypsum Dike - Typical Section |
| Figure 14 | Northeast Gypsum Dike and Recycle Dam - Instrument Location Plan |
| Figure 15 | Northeast Gypsum Dike and Recycle Dam - Typical Section |

TABLE OF CONTENTS

(continued)

| | |
|-----------|--|
| Figure 16 | ARD Pond - Instrument Location Plan |
| Figure 17 | ARD Pond - Typical Sections |
| Figure 18 | Calcine Pond Dike - Instrument Location Plan |
| Figure 19 | Calcine Pond Dike - Typical Section |
| Figure 20 | Sludge Pond Dikes Plan |
| Figure 21 | Sludge Pond Dikes - Typical Section |

List of Appendices

| | |
|---------------|---|
| Appendix I | 2017 Dam Safety Inspection Forms and Facility Data Sheets |
| Appendix II | 2017 Photographs |
| Appendix III | 2017 Instrumentation Monitoring |
| Appendix IV | Iron Dike (Emergency Storage Pond) Instrumentation Data |
| Appendix V | Old Iron Dike Instrumentation Data |
| Appendix VI | Siliceous Dikes Instrumentation Data |
| Appendix VII | West Gypsum Dike Instrumentation Data |
| Appendix VIII | East Gypsum Dike Instrumentation Data |
| Appendix IX | Northeast Gypsum Dike Instrumentation Data |
| Appendix X | ARD Pond South Dam and North Dam Instrumentation Data |
| Appendix XI | Sludge Pond Dike Crest Profiles |
| Appendix XII | Summary of Climate and Water Balance Data |

1 INTRODUCTION

1.1 Purpose, Scope of Work and Methodology

This report presents the results of the 2017 Annual Dam Safety Inspection (DSI) of the tailings dikes and other dams at the Teck Metals Ltd. (Teck) former Sullivan Mine, located in Kimberley, British Columbia. The work was carried out in general accordance with our proposal letter dated January 18, 2017 (and subsequent change orders dated April and August 2017) and the Teck Guideline for Tailings and Water Retaining Structures (Teck 2014).

The scope of work consists of:

- A visual inspection of the physical conditions of the various containment dikes and water retention dams during the site visit May 10th and 11th, 2017, which included:
 - ♦ Reading of select piezometers at the West Gypsum Dikey
 - ♦ Reading of select piezometers at the Siliceous Pond #2 and #3 Dikes;
- A review of the water balance data for the site;
- A review of annual flow rates recorded from weirs for the ARD Pond and AIP;
- A review of updated piezometer and settlement records provided by Teck in 2017; and,
- A review of the OMS and ERP/EPP Manuals for the tailings facilities.

As in previous years, this report focuses on the geotechnical performance of the tailings dikes and water balance for the tailings facilities. Teck addresses and reports water discharge and water quality separately. The reporting period for this DSI is from September 1, 2016 through August 31, 2017. Figure 1 shows the project location and general layout of the tailings facilities.

This is the 26th consecutive annual inspection of the Sullivan Mine tailings dikes carried out by Klohn Crippen Berger Ltd. (KCB), formerly Klohn Crippen Consultants Ltd. Annual inspection reports for the periods preceding KCB's involvement were prepared by SRK-Robinson Inc. from 1989 to 1991 and by Robinson Dames and Moore from 1984 to 1988.

1.2 Regulatory Requirements

1.2.1 Mines Act and HSRC

This DSI addresses the performance of the tailings/sludge storage facilities and associated water management infrastructure in accordance with the most recent Health, Safety and Reclamation Code for Mines in British Columbia (MEMPR, 2016 & MEMPR, 2017), which forms part of the Mines Act (RSBC 1996).

As required by the HSRC, the following persons have been designated:

- Engineer of Record – Ms. Karen Masterson, P.Eng. (KCB)
- Tailings Storage Facility Qualified Person – Ms. Kathleen Willman, P.Eng. (Teck)

1.2.2 Water Act and BC Dam Safety Regulation

None of the dikes or dams at Sullivan Mine require a water licence and are therefore not regulated by the BC Dam Safety Regulations. However, the BC Dam Safety Regulation was referenced for guidance related to dam safety.

1.2.3 Permits and Licences

Sullivan Mine is regulated by the following permits:

- Reclamation Permit M-74 (September 29, 2017) issued by the Ministry of Mines. This permit is issued under the provision of the Mines Act (RSBC 1996), and addresses reclamation and metal leaching and acid rock drainage requirements at Sullivan Mine. The requirements of the permit are:
 - ◆ monitoring programs of vegetation, surface water and groundwater;
 - ◆ annual reporting, as required under the HSRC (MEMPR 2017); and
 - ◆ informing the ministry of changes at the mine that might impact the amount of the reclamation security.
- Effluent Permit PE-00189 (Oct. 24, 2016), issued by the Ministry of Environmental Protection & Sustainability: Waste Management. This permit is issued under the provision of the Environmental Management Act (SBC 2003), and authorizes the discharge of effluent in Kimberley Creek and St. Mary River as well as sludge on land. Requirements under this permit include:
 - ◆ general requirements (Section 2 of the permit), which state the conditions under which the DWTP and Sludge Pond must be operated (i.e., maintaining the infrastructure in good working order, addressing emergencies, modification to infrastructure and processes, bypasses and suspension); and
 - ◆ monitoring and reporting requirements (Sections 3 and 6 of the permit), which describe monitoring work to conduct on the discharges and receiving environment as well as the reporting frequency (i.e., spring and fall).
- Permit PR6742 (January 15, 2013), issued by Ministry of Environmental Protection & Sustainability: Waste Management. This permit is issued under the provision of the Environmental Management Act (SBC 2003), and authorizes the discharge of refuse to a landfill. The landfill is located within the boundaries of the Old Iron Pond (northwest corner) and is denoted as E242184 by the Ministry. Requirements under this permit include:
 - ◆ Report volumes of material placed within landfill; and
 - ◆ Regularly inspect and maintain the landfill works.

1.3 Facility Description

There is a total of 15 earthfill dam and dike structures that create seven separate storage facilities (the Northeast Gypsum Dike and Recycle Pond Dike are included in the Gypsum Ponds). A summary of the seven facilities is provided in Table 1.1. The earthfill structures have a combined length of just over 10.4 km, with maximum heights varying from about 4.3 m to 29 m. A plan of the storage facilities and their retaining structures is provided on Figure 1.

The two water retaining dams⁶, designated as the North Dam and South Dam, that form the ARD Pond are shown in Figures 3 and 16. This pond, located at the old Cooling Pond site, annually stores the water requiring treatment. Other than the North and South Dams of the ARD Pond, which are water retaining structures, and the North and South Dikes of the Sludge Pond, the dikes listed in Table 1.1 have been used primarily for tailings storage. Typically, these dikes consist of an initial earthfill starter section, which were then raised incrementally over the years using the upstream method of construction. The design and construction records for the original Old Iron Pond dikes and the No. 1 Siliceous Pond Dike are not available so it is unclear how these were originally constructed. In the 1990's stability assessments for all of the tailings dikes were completed and where required slopes were flattened and toe berms were constructed to meet required design criteria. A discussion of the design basis and criteria are provided in Section 5.1.

The Emergency Storage Pond (ESP), formerly the Iron pond, the ARD Pond, the West Gypsum seepage collection ponds, and the Northeast Gypsum and Recycle seepage collection ponds are the only storage facilities retaining water at the Sullivan Mine. The Sludge pond is also active but does not retain any ponded water. The other tailings facilities have been decommissioned and surface reclamation is complete. The reclamation has included draining and covering the tailings pond surfaces and the construction of surface water runoff conveyance channels and spillways.

Water collected at Sullivan Mine through mine drainage, contaminated groundwater and seepage from tailings ponds and waste dumps is stored in the ARD Pond and then pumped to the Drainage Water Treatment Plan (DWTP). The ARD Pond serves as a flow equalization basin to facilitate seasonal operating campaigns at the DWTP. The treated water is released to the environment (St. Mary River) and the sludge is deposited in the Sludge Pond. The ARD Pond was designed with a spillway, which connects to the ESP. The ESP in-turn has a spillway to safely conduct excess water from the dikes/dams, which connects to Cow Creek, which in turn empties into the St. Mary River.

⁶ In this report KCB refers to “dams” as water retaining structures engineered to retain or limit seepage, and refers to “dikes” as the structures that are constructed as part of the tailings facilities.

Table 1.1 Summary of Storage Facilities at Sullivan Mine

| Storage Facility | Embankments | Type | Approximate Embankment Length (m) | Approximate Maximum Height (m) | Starter Dike Constructed (Year) ¹ | Year Of Last Dike Raise (Year) |
|------------------------------------|----------------------|-----------------------|-----------------------------------|--------------------------------|--|--------------------------------|
| Iron Pond (Emergency Storage Pond) | Iron Dike | Iron Tailings | 1500 | 29.0 | 1975 | 1999 |
| Old Iron Pond | Southwest Limb | Iron Tailings | 520 | 7.6 | Unknown | Unknown |
| | Southeast Limb | Iron Tailings | 1190 | 2-3 ³ | Unknown | Unknown |
| Siliceous Ponds | No. 1 Siliceous Dike | Silica Tailings | 2000 | 7.6 ³ | 1923 | 1979 |
| | No. 2 Siliceous Dike | Silica Tailings | 730 | 9.5 | 1975 | 1982 |
| | No. 3 Siliceous Dike | Silica Tailings | 1540 | 12.5 | 1975 | 1984 |
| Gypsum Ponds | East Gypsum Dike | Gypsum | 670 | 16.8 | 1969 | 1983 |
| | West Gypsum Dike | Gypsum | 640 | 22.9 | 1969 | 1986 |
| | Northeast Dike | Gypsum, Seepage Water | 120 | 10.0 | 1985 | 1985 |
| | Recycle Pond | Seepage/ARD Water | 90 | 6.0 | 1985 | 1985 |
| Calcine Pond | Calcine Dike | Calcine | 520 | 4.6 ³ | 1972 | 1986 |
| ARD Pond (see note 2) | North Dam | ARD/Seepage Water | 460 | 7.6 | 2001 | 2001 |
| | South Dam | ARD/Seepage Water | 330 | 16.8 | 1976 | 2001 |
| Sludge Pond | North Dike | Sludge | 120 | 4.3 | 1978 | 1978 |
| | South Dike | Sludge | 200 | 6.1 | 1978 | 1978 |

Notes:

1. Starter Dike information based on data from Annual Inspection Report by SRK-Robinson dated June 1991.
2. The ARD Pond is established at the site of the old Cooling Pond.
3. Tailings were placed downstream of both Southeast Limb and Siliceous Pond #1 Dikes. The original height of the Southeast Limb and Siliceous Pond #1 Dike from original ground is 10.7 m and 16.8 m, respectively. A municipal landfill is downstream from the Calcine Pond Dike. The height of the Calcine Dike from original ground is 15.2 m.

Site location plans, and plans and typical sections of the dikes/dams are provided in Figures 1 through 21 as follows:

- Figure 1 Location and Site Plan
- Figure 2 Tailings Seepage Collection and the DWT Plant Location
- Figure 3 General Arrangements of Tailings Facilities
- Figure 4 Iron Pond Dike - Instrument Location Plan
- Figure 5 Iron Pond Dike - Typical Sections
- Figure 6 Old Iron Pond Dike - Instrument Location Plan
- Figure 7 Old Iron Pond Dike - Typical Section
- Figure 8 Siliceous Pond Dikes No 1, 2 & 3 - Instrument Location Plan
- Figure 9 Siliceous Pond Dikes No 1, 2 & 3 - Typical Sections
- Figure 10 West Gypsum Dike - Instrument Location Plan
- Figure 11 West Gypsum Dike - Typical Section
- Figure 12 East Gypsum Dike - Instrument Location Plan
- Figure 13 East Gypsum Dike - Typical Section
- Figure 14 Northeast Gypsum Dike and Recycle Dam - Instrument Location Plan
- Figure 15 Northeast Gypsum Dike and Recycle Dam - Typical Section
- Figure 16 ARD Pond - Instrument Location Plan
- Figure 17 ARD Pond - Typical Sections
- Figure 18 Calcine Pond Dike - Instrument Location Plan
- Figure 19 Calcine Pond Dike - Typical Section
- Figure 20 Sludge Pond Dikes - Plan
- Figure 21 Sludge Pond Dikes - Typical Section

1.4 Background Information and History

After almost a century of operations, the Sullivan Mine was closed at the end of 2001, with approximately 94,000,000 tonnes of tailings and 16,900,000 tonnes of mine waste stored at the former mine. Reclamation work on the tailings areas commenced in 1990, and was essentially complete by 2008.

The mine had been mainly underground and operated on a near-continuous basis from the early 1900s to 2001. In the last decade prior to closure, the mine was processing primarily lead/zinc ore. For most of the mine's operating life, mill tailings were hydraulically transported to an area immediately southeast of the Concentrator for disposal and storage. The historical development of the tailings areas is summarized in Table 1.2. Gypsum and circulation water from operation of the

fertilizer plant have also been stored in the tailings area. These by-products from the fertilizer plant were produced and stored from about 1969 to 1987.

A Drainage Water Treatment Plant (DWTP), which began operating in 1979, continues to operate as part of the water management plan for the site. The DWTP treats acid rock drainage and other seepage produced from the underground mine and waste storage facilities. Sludge from the water treatment plant (DWTP) is located in a pond about 2 km south of Marysville near the DWTP. Figure 2 illustrates the relative locations of the DWTP, the tailings facilities, and the pipelines from the underground mine and highlights the primary seepage collection system.

Table 1.2 Historical Development

| Date | Process | Storage Area | Comments |
|-----------------|--|--|---|
| Prior to 1941 | Milling/Flotation for lead and zinc recovery | One tailings stream to Old Iron Pond | |
| 1941 to 1985 | Tin Recovery Circuit | Iron tailings to Old and Iron Pond Siliceous tailings to No. 1, 2, 3 Siliceous Ponds | |
| 1953 to 1987 | Fertilizer production including roasting of iron concentrate. Waste products include Iron Oxide and Gypsum | Iron Oxide (known as calcine tailings) to Calcine Pond. Gypsum tailings to East and West Gypsum Ponds | Gypsum Ponds not developed until 1968, prior to that gypsum tailings were stored and seasonally discharged to the St. Mary River during spring freshet. |
| 1975 to 1987 | Fertilizer Plant effluent water | Stored and recycled from Cooling Ponds 1 and 2 | |
| 1987 to 2001 | Fertilizer plant closed; single mill tailings stream | Single stream to Iron Pond | |
| 1979 to present | Drainage Water Treatment Plant (DWTP) Sludge Pond | Sludge storage | Located off site 1.5 km south of Marysville, 0.5 km south of Drainage Water Treatment Plant DWTP. |
| 2001 | Water storage for feed to Drainage Water Treatment Plant (DWTP) | Cooling Ponds 1 and 2 converted to Acid Rock Drainage (ARD) Pond | |

1.4.1 Reference Reports

Beginning in 1991, Teck retained KCB to review the existing and long-term stability of a number of the tailings dikes. These studies were part of Teck efforts toward decommissioning and eventual closure of the Sullivan Mine tailings facilities. Stability assessments were completed for the Iron Pond Dike, the East and West Gypsum Dikes, the No. 1, No. 2 and No. 3 Siliceous Dikes, and the Southwest Limb of the Old Iron Dike. A design of two new dams for the ARD pond was also completed including new spillways and a downstream flood impact study. Additional assessments post-closure have been performed as required based on performance. The main conclusions and recommendations from the studies are documented in the following KCB reports:

- Iron Dike Tailings Facility: 1991 Failure Assessment, dated February 20, 1992.

- Iron Dike Tailings Facility: Dike Stabilization, dated March 13, 1992.
- Stability Review of Gypsum Dikes, dated November 26, 1993.
- Stability Review of Southwest Limb of Old Iron Dike, dated June 21, 1994.
- Stability Review of Siliceous Dikes, dated June 24, 1994.
- 1993 – 1994 Annual Inspection of Tailings Dikes (Sections 5.5, 9.4, 10.4, and 11.4, Typical Dike Cross-Section and Factors of Safety) dated October 21, 1994.
- Iron Dike: Geotechnical Design of 1995 Dike Raise, dated May 18, 1995.
- 1999 Annual Inspection of Tailings Dikes (Section 4.4 – Iron Pond Dike, Stability Review) dated September 16, 1999.
- Iron Pond Dike – Construction Recommendations for Float Rock Toe Berm, dated January 24, 2000.
- ARD Pond - Storage Pond No. 1 Design Report, dated February 29, 2000 and addendum letter dated August 21, 2000.
- ARD Pond - Storage Pond No. 1 Construction Record Report dated January 31, 2002.
- Geotechnical Design Basis for Tailings Dikes – Overview Summary Report, dated January 9, 2002.
- ARD Pond - Dam Breach and Inundation Study, Storage Pond No. 1 dated September 6, 2002.
- ARD and Emergency Storage Ponds - Potential Downstream Flood Impacts from Spillway Flows dated November 14, 2002.
- Southwest Limb Stability Review dated July 28, 2006.
- Geotechnical Stability Analysis of Sullivan Mine CPR Ballast Deposition Site, dated February 28, 2007.
- Sullivan Mine Tailings Area, Emergency Storage Pond (ESP) Spillway Design dated September 28, 2007.
- Sullivan Mine Iron Pond Dike Stability dated May 11, 2011.
- Sullivan Mine Emergency Storage Pond, Surface Water Management Plan Update dated December 8, 2011.
- TML Sullivan Mine Tailings Facility: Iron Pond Dike – Artesian Pressures in Confined Aquifer (Piezometers P92-H and P92-25) dated November 18, 2015.

The following report authored by others provided additional information:

- Dam Break Inundation Study for Three Containment Structures Sullivan Mine, BC – Final Report dated November 26, 2014. Prepared by AMEC Environment & Infrastructure, A Division of AMEC Americas Limited.

1.4.2 Reference As-Built Drawings

Teck has updated as-built drawings for the various facilities post reclamation. Table 1.3 provides a summary of these drawings, which were prepared for Teck by TM Tech Services. An updated LiDAR image created in December 2012 of the site was provided by Teck and used to update the figures attached to this report. We understand there has been no significant construction/modifications to the as-built conditions since the drawings by TM Tech Services were issued.

Table 1.3 Summary of Drawings Prepared by TM Tech Services

| Title | Drawing | Date |
|--|----------------|-------------|
| Site Plans | | |
| TAILINGS SEEPAGE COLLECTION/DWT PLANT SYSTEM PIPING DETAILS | K100 A 3007 | FEB 3/09 |
| DAM SAFETY REVIEW KEY PLAN | K100 A 3010 | MAR 23/09 |
| Gypsum Ponds | | |
| WEST GYPSUM DIKE PLAN VIEW | K100 A 3230 | JAN 29/07 |
| WEST GYPSUM DIKE PROFILE / SECTIONS | K100 A 3231 | JAN 29/07 |
| EAST GYPSUM DIKE PLAN /PROFILE /SECTIONS | K100 A 3232 | JAN 29/07 |
| Iron Pond & Overflow Spillway (Emergency Storage Pond Dike) | | |
| EMERGENCY POND DIKE PLAN VIEW (FORMER IRON POND) | K100 A 3233 | FEB 13/09 |
| EMERGENCY POND DIKE PROFILE/SECTIONS (FORMER IRON POND) | K100 A 3234 | FEB 13/09 |
| EMERGENCY POND OVERFLOW SPILLWAY AS BUILT | K100 A 3235 | FEB 13/09 |
| West Gypsum Pond Ditching | | |
| WEST GYPSUM POND DITCHING PLAN VIEW | K100 A 3236 | JAN 14/09 |
| WEST GYPSUM POND DITCH PROFILES | K100 A 3237 | JAN 14/09 |
| WEST GYPSUM POND DITCHING SECTIONS 1 TO 7 | K100 A 3238 | JAN 14/09 |
| Calcine Pond | | |
| CALCINE DIKE PLAN /PROFILE /SECTIONS | K100 A 3239 | DEC 4/06 |
| SW Limb | | |
| SW LIMB AS BUILT (OLD IRON POND) | K100 A 3240 | JAN 16/09 |
| SE Limb | | |
| SE LIMB AS BUILT | K100 A 3246 | FEB/12/09 |
| Siliceous Ponds | | |
| SILICEOUS PONDS 1/2/3 AS BUILT PLAN/PROFILE | K100 A 3241 | JAN/26/09 |
| SILICEOUS PONDS 1/2/3 AS BUILT SECTIONS | K100 A 3242 | JAN/26/09 |
| ARD Pond | | |
| ARD POND, NORTH & SOUTH DIKE AS BUILT | K100 A 3243 | FEB 4/08 |
| ARD POND, NORTH & SOUTH DIKE AS BUILT | K100 A 3244 | JAN 29/09 |
| ARD POND OVERFLOW SPILLWAY AS BUILT | K100 A 3245 | JAN 31/09 |
| Iron Pond to Cow Creek | | |
| SURFACE WATER CHANNELS D, E, F AND G PLAN VIEW | K100 A 3254 | MAR 11/09 |
| SURFACE WATER CHANNELS D, E, F AND G PROFILE AND SECTIONS | K100 A 3255 | MAR 11/09 |
| North of Siliceous Ponds to Luke Creek | | |
| SURFACE WATER CHANNELS M,P1,O,& P2 PLAN VIEW | K100 A 3310 | MAR 4/09 |
| SURFACE WATER CHANNELS M,P1,O,& P2 PROFILE /SECTIONS | K100 A 3311 | MAR 4/09 |
| Sludge Pond | | |
| SLUDGE POND DIKE CREST AS BUILT | K101 A 2240 | DEC 10/08 |
| SLUDGE POND DIKE CREST AS BUILT | K101 A 2249 | SEP 11/17 |
| SLUDGE POND SURFACE AS-BUILT | K101 A 2243 | SEP 9/15 |

1.4.3 Units of Measure and Reference Coordinates

To facilitate the long-term monitoring of the site, this report has converted historical values, recorded in Imperial units of measure in the Sullivan Mine Grid coordinate system, to metric units in UTM (NAD 83). Some figures still reference stationing along dikes to the Imperial units.

2 CONSTRUCTION AND OPERATION DURING 2017

2.1 Tailings Deposition – Not Applicable

Sullivan Mine is a closed facility.

2.2 Available Tailings Storage – Not Applicable

Sullivan Mine is a closed facility.

2.3 Construction and Operations Activities (2017)

The mine was closed at the end of 2001, and since this time the facility has not been used for tailings deposition.

The main construction activities that take place each year are related to ongoing care and maintenance activities such as road grading, cleaning of ditches, rodent burrow repair, removal of trees and shrubs from dike slopes and maintenance of the seepage collection system. However, additional reviews and designs may occur to support changes to government regulations and operations. There are also activities that occur each year to support operation of the seepage management and water collection systems. Between October 1, 2016 and August 31, 2017, the following additional activities occurred:

- Ongoing review of ARD storage and stormwater management capacities – KCB is assisting Teck with this work. Included is a review and update of the surface hydrology including inflow design flood (IDF) and Probable Maximum Flood (PMF). KCB submitted two reports in 2017 in relation to this work: one assessing the feasibility of increasing ARD storage and one reviewing sludge deposition in the ARD Pond. These were interim reports and work is ongoing and expected to continue into 2018 and 2019.
- A letter was provided in Q4 2016 to Teck, which presented the quantifiable performance objectives in place for Sullivan Mine as required by MEMPR (Summary of Exceptions August 15, 2016) under the revised Part 10 of the HSRC.

2.4 Updated Cross Sections

Sullivan Mine is closed facility. While there are ongoing activities related to the operation and maintenance of the seepage collection and water treatment system (see Section 3.2), there have been no changes to the dikes/dams during the reporting period. Typical cross-sections for each structure are included with this report (see Section 1.3 for a list).

3 CLIMATE DATA AND WATER BALANCE DURING 2017

The MEMPR Guidelines for Annual Dam Safety Inspection Reports require a water balance review. The tailings facilities at Sullivan Mine have been closed and reclaimed. The only active storage facilities are the ARD Pond, Emergency Storage Pond, Sludge Pond and West Gypsum Seepage Collection Pond. As generally all the water collected passes through the ARD Pond or is bypassed directly to the DWTP, the focus for the water balance is the ARD Pond. The reporting period for the water balance review is October 1, 2016 to August 31, 2017. The records of operating water level for the Emergency Storage Pond (ESP) are also included to review the freeboard and available storage in the pond.

3.1 Review and Summary of Climate Data

3.1.1 Precipitation and Runoff

The precipitation and runoff determined for this water balance is only for the ARD Pond as any precipitation and runoff for the other tailings facilities are included in the net flows reporting via the seepage collection ditches and pumps.

Climate stations in the Environment Canada (EC) database relevant to the Sullivan Mine Tailings Facilities precipitation and active during the time period of this water balance assessment are Kimberley PCC (Station No. 1154203) located approximately 3 km southwest of the mine and Cranbrook A (Station No. 1152105) located about 13 km south east of the mine.

Figure XII-1 in Appendix XII shows the monthly precipitation recorded by the climate stations, as well as the values of Climate Normals for 1981 to 2010. Based on the trend of the 30-year climate normals shown on the figure, the total precipitation in Kimberley is generally higher than Cranbrook from October to April. The trend becomes reversed for the rest of year, and Cranbrook would be expected to experience more precipitation than Kimberley. However, the precipitation records in 2016 and 2017 indicate a drier year in Kimberley than Cranbrook, with almost no rainfall in the summer in Kimberley.

For the purpose of this assessment, the daily precipitation recorded at Kimberley PCC was used for the site. Any missing data was replaced by precipitation recorded at the Cranbrook A stations. Total precipitation estimated for the mine from October 1, 2016 to August 31, 2017 is 438 mm. Figure XII-2 shows the variation of precipitation during the time period.

The precipitation on the ARD Pond falls either directly on the water surface or on the inner side of the pond banks. For the purpose of inflow estimation, 100% of the direct precipitation on the water surface was considered. Because of losses due to infiltration and interception, it was assumed that only 50% of the precipitation on the side banks should be added to the water storage in the pond. The pond surface area at the beginning of each month was estimated based on the Area-Volume curve (Figure XII-3), and the bank area would be the difference between its area at top of the dam (1048.0 m) and the pond surface area at the same date. The estimated precipitation and runoff volumes are shown on Table 3.1.

Table 3.1 ARD Pond: Precipitation Inflow

| Month | Year | Precipitation (mm) | Direct Precipitation on the Pond Surface Volume (m ³) | Runoff on the Inside Bank Volume (m ³) | Total Precipitation Inflow Volume (m ³) |
|--------------|------|--------------------|---|--|---|
| October | 2016 | 112 | 3,721 | 3,909 | 7,631 |
| November | 2016 | 21 | 1,134 | 517 | 1,651 |
| December | 2016 | 54 | 3,533 | 1,020 | 4,554 |
| January | 2017 | 10 | 755 | 149 | 904 |
| February | 2017 | 93 | 7,660 | 990 | 8,650 |
| March | 2017 | 67 | 5,702 | 596 | 6,299 |
| April | 2017 | 43 | 3,219 | 609 | 3,829 |
| May | 2017 | 28 | 1,772 | 539 | 2,310 |
| June | 2017 | 18 | 972 | 433 | 1,404 |
| July | 2017 | 2 | 75 | 45 | 120 |
| August | 2017 | 1 | 27 | 28 | 55 |
| Total | | 438 | 27,231 | 8,972 | 36,204 |

3.1.2 Evaporation

Lake evaporation from a small open water-body is only measured at selected climate stations and published online by Environment Canada. Duncan Lake Dam (Station No. 1142574) located about 100 km northwest of the mine is the closest station where the Climate Normals data, including the lake evaporation, is available. For that station, the climate normals are estimated based on about 30 years of data, from 1981 to 2010 (Table 3.2).

Table 3.2 Lake Evaporation at Duncan Lake Dam Station (Source: Environment Canada)

| Month | Number of Days | Daily Lake Evaporation (mm) | Monthly Evaporation (mm) |
|-------------------|----------------|-----------------------------|--------------------------|
| January | 31 | 0 | 0 |
| February | 28 | 0 | 0 |
| March | 31 | 0 | 0 |
| April | 30 | 0 | 0 |
| May | 31 | 2.9 | 90 |
| June | 30 | 3.4 | 102 |
| July | 31 | 3.3 | 102 |
| August | 31 | 2.9 | 90 |
| September | 30 | 1.8 | 54 |
| October | 31 | 0 | 0 |
| November | 30 | 0 | 0 |
| December | 31 | 0 | 0 |
| Total (mm) | | | 438 |

The evaporation loss from the ARD Pond was estimated by multiplying the monthly evaporation with the water surface area in the pond (Table 3.3).

3.2 Review and Summary of Water Balance

Teck has developed a specially designed multi-layer soil cover system of float rock and till for reclamation of the tailings areas. In addition, surface water collection channels and spillways have been designed and constructed. The main channels and spillways have been designed to safely pass the Probable Maximum Flood (PMF) storm events. In addition, storage of the 100-year snowmelt event and controlled release of the 1000-year snowmelt event has also been provided for, if it cannot be stored. The channels are riprap lined and incorporate stilling basins, where required. Several spillways and channels are used to assist in controlled release of excess water. The tailings area drains to the St. Mary River, primarily through the Cow, James and Luke Creek drainages.

Groundwater management involves the collection and treatment of mine drainage, contaminated groundwater, and seepage from tailing ponds and waste dumps. Details of the system are included in the Kimberley Operations Seepage Collection Manual (Teck, 2017). The mine water from the underground workings is pumped seasonally from the 3700 ft. portal and from the 3900 ft. mine level to the ARD Pond. The water from the waste dumps and the tailings seepage collection pumps and sumps is pumped as required to the ARD Pond to facilitate seasonal operating campaigns at the Drainage Water Treatment Plant. The ARD Pond can be by-passed with temporary discharge of mine water (underground and dumps) and seepage water to the ESP, which can then be pumped to the DWTP if required.

The ARD Pond has a relatively large storage capacity, thereby allowing efficient operation of the DWTP for discrete periods of time. It provides some control over the time period when treated effluent is discharged to St. Mary River. Water collected in the ESP is pumped as required to the ARD Pond or directly to the DWTP. The ESP provides storage volume for ARD contaminated water during spring run-off events.

3.2.1 Area-Volume Curve

ARD Pond

The retaining dikes of the pond are the South and North Dams built in 2001. The dam crest elevation is at El. 1048.0 m, and the pond's spillway crest elevation is at 1047.4 m with the pond Maximum Operating Level (MOL) set at 1046.5 m (Klohn Crippen 2000). Figure XII-3 shows the pond area-volume curve used for the water balance assessment. Based on that curve, at MOL, the pond surface area is approximately 100,359 m² and its storage volume reaches 710,500 m³.

ESP

The ESP was intended for emergency storage when the capacity of the ARD Pond was exceeded. During normal operation, the surface runoff from the Iron Pond and the upstream area is collected in the ESP before pumping to the ARD Pond or directly to the DWTP. The LiDAR survey from 2012, provided by Teck, shows the elevation of the spillway crest and top of the dike to be at 1041.0 m and 1042.0 m, respectively. The stage-storage curve (KCB, 2007) for the pond is shown on Figure XII-4. Based on the curve, the storage capacity of the ESP pond before spilling over the Emergency Spillway is 380,000 m³.

3.2.2 Water Level Variation

ARD Pond

Figure XII-2 shows the recorded water levels by Teck in the ARD Pond during the time period from October 2016 to August 2017. The pond level is recorded weekly, although daily readings are available at certain times of the year when instrumentation is required to be read daily.

Based on the pond water levels, the maximum level observed during the time period was 1044.6 m, which occurred on March 14, 2017. This is 1.9 m lower than the maximum operating level (MOL) and 2.8 m below the spillway crest elevation. Therefore, water never spilled over the spillway to the ESP during the water balance time period. Records show that water has never spilled from the ARD pond during its operation.

ESP

Figure XII-5 shows the recorded water levels by Teck in the ESP. The levels are available in daily intervals, and show the pond level variation due to rainfall and snowmelt and pumping from ESP to ARD Pond. Note during Q3 2017, increased pond levels were due to a temporary diversion of seepage water from the mine from the ARD Pond into the ESP. The figure indicates that pond level peaked at 1038.8 m on April 9, 2017, which is 2.2 m lower than the spillway crest. Therefore, the pond never spilled over the spillway into the downstream channels. Records show that water has never spilled from the ESP since closure.

3.2.3 Inflows / Outflows

The main components of the ARD Pond water balance are the inflows and outflows, as shown on Figure 2 and described below. The inflows include direct precipitation on the pond surface and runoff on the inner banks of the pond as well as collected seepage and drainage from the following:

- The Emergency Storage Pond through pumps 905, 906, 907, 908;
- Seepage from the Iron, Gypsum and Siliceous Ponds, which is collected in the West Gypsum seepage collection pond, through pumps 945, 946; and
- The discharge from the mine through the 3700 and 3900 Mine Lines. The 3700 line carries water from the underground mine to the ARD Pond for eventual treatment. The 3900 Line collects water from the waste dumps, aquifer dewatering wells, and Sullivan Creek as well as pump 940, which collects seepage from the Old Iron Pond.

The pond outflows include the following:

- Pumping to the DWTP through pumps 947, 948, 949, 950 and 952. This is referred to as Plant Feed in Teck's pumping records;
- Discharge to the Emergency Storage Pond through the spillway (would only occur during a flood event);
- South Dam embankment seepage, which is monitored by ARDWU (formerly Weir #1). The seepage is returned to the pond through the seepage collection ditches and pumps; and

- Evaporation from the pond surface.

Teck provided the available pumping data and weir data. There are other pumps (953/954, 943/944, and 951) which collect seepage and drainage, however, as noted above, those pumps direct water to the West Gypsum seepage collection pond prior to the collected water being pumped to the ARD Pond.

The pumping data received for pumps 947, 948, 949, 950 and 952 (or DWTP plant feed) is not reliable from April 5th through August 15th, 2017, due to a malfunction of the flow meter (Pers. email from Dana Haggar). The flow meter was under reporting flow volume sent to the DWTP.

A summary of the monthly inflow and outflow volumes for the ARD Pond is provided in Table 3.3. The observed water level and the pond storage at the beginning of each month are noted at the top of the table, followed by the inflows and outflows, which are based on the data available. Based on the monthly water balance, the water level in the pond is estimated and compared to the observed water level. As noted in Section 3.2.2, the observed water level did not reach the MOL, 1046.5 m, and there was no spill to the Emergency Storage Pond.

At the end of each month, the pond storage is calculated based on the inflows and outflows, and it is presented as Calculated End of Month Storage. The Observed End of Month Storage is also estimated using the recorded water levels and the stage–storage curve for the pond. The comparison of the calculated and observed end of month storage indicates there is some discrepancy for some months. For example, in October 2016, the calculated storage is 48,917 m³, whereas the observed storage is 76,774 m³.

The last two lines in the table show the water level and storage difference between the calculated and observed data for each month. There is a significant discrepancy for June and July, which is expected due to the under reporting of flows by the 947, 948, 949, 950 and 952 pumps' flow meter. Sullivan site personnel have also noted that not all the flow meters are installed at ideal locations and therefore flow measurements will inherently be inaccurate. This is most likely true for the outflow from the ARD Pond as the calculated and observed storage match well when the DWTP is shut down. This has been the trend for previous year's water balance data. There is also inherent uncertainty for the precipitation, runoff, evaporation and seepage volumes estimated for the pond although these volumes are small compared to the pumped flows.

Table 3.3 ARD Pond: Monthly Water Balance Summary

| Description | Units | Oct. 2016 | Nov. 2016 | Dec. 2016 | Jan. 2017 | Feb. 2017 | Mar. 2017 | Apr. 2017 | May 2017 | Jun. 2017 | Jul. 2017 | Aug. 2017 | Oct. 2016 – Aug. 2017 |
|-------------------------------------|------------------------|----------------|----------------|----------------|----------------|----------------|----------------|----------------|----------------|----------------|----------------|----------------|-----------------------|
| Beginning Water Level | (m) | 1039.10 | 1038.04 | 1040.05 | 1041.66 | 1042.98 | 1044.11 | 1042.12 | 1041.48 | 1039.42 | 1038.60 | 1036.21 | 1039.10 |
| Beginning Storage | (m ³) | 134,039 | 81,960 | 187,700 | 293,144 | 393,267 | 487,784 | 326,692 | 280,258 | 151,424 | 108,382 | 20,506 | 134,039 |
| Inflow: | | | | | | | | | | | | | |
| Pump 905/906/907/908 | (m ³) | 2,953 | 0 | 0 | 0 | 0 | 44,393 | 137,430 | 24,740 | 9,004 | 974 | 655 | 220,149 |
| Pump 945 / 946 | (m ³) | 49,402 | 54,375 | 50,038 | 51,031 | 49,139 | 89,392 | 169,931 | 104,426 | 75,763 | 41,306 | 51,065 | 785,868 |
| Mine Line 3700 | (m ³) | 41,501 | 0 | 0 | 0 | 0 | 4 | 0 | 255,978 | 264,012 | 169,136 | 66,580 | 797,211 |
| Mine Line 3900 | (m ³) | 75,468 | 68,211 | 73,781 | 68,171 | 58,773 | 76,092 | 237,735 | 181,674 | 106,601 | 57,295 | 50,349 | 1,054,150 |
| Precipitation and Runoff | (m ³) | 7,631 | 1,651 | 4,554 | 904 | 8,650 | 6,299 | 3,829 | 2,310 | 1,404 | 120 | 55 | 37,406 |
| Total Inflow | (m³) | 176,955 | 124,237 | 128,373 | 120,106 | 116,562 | 216,180 | 548,925 | 569,128 | 456,784 | 268,831 | 168,704 | 2,894,784 |
| Outflow: | | | | | | | | | | | | | |
| Pump 947/948/949/950/952 | (m ³) | 262,462 | 0 | 0 | 0 | 0 | 342,278 | 664,570 | 685,377 | 459,211 | 313,438 | 78,859 | 2,806,195 |
| ARDWU ³ | (m ³) | 112 | 0 | 73 | 0 | 819 | 2,634 | 2,394 | 1,033 | 285 | 0 | 0 | 7,349 |
| Evaporation | (m ³) | 0 | 0 | 0 | 0 | 0 | 0 | 0 | 5,597 | 5,444 | 3,833 | 2,558 | 17,433 |
| Total Outflow | (m³) | 262,574 | 0 | 73 | 0 | 819 | 344,912 | 666,964 | 692,007 | 464,940 | 317,271 | 81,417 | 2,830,977 |
| Net Volume (Inflow - Outflow) | (m ³) | -85,619 | 124,237 | 128,300 | 120,106 | 115,743 | -128,732 | -118,039 | -122,878 | -8,155 | -48,441 | 87,286 | 63,807 |
| Calculated End of Month Storage | (m ³) | 48,420 | 206,197 | 316,000 | 413,250 | 509,010 | 359,051 | 208,653 | 157,380 | 143,269 | 59,942 | 107,792 | 197,846 |
| Observed End of Month Storage | (m ³) | 76,774 | 182,905 | 289,541 | 389,331 | 485,119 | 325,178 | 290,261 | 151,968 | 109,901 | 19,922 | 116,980 | 116,980 |
| Calculated End of Month Water Level | (m) | 1037.20 | 1040.35 | 1041.98 | 1043.22 | 1044.35 | 1042.55 | 1040.39 | 1039.53 | 1039.27 | 1037.52 | 1038.59 | 1040.22 |
| Observed End of Month Water Level | (m) | 1037.92 | 1039.97 | 1041.61 | 1042.93 | 1044.08 | 1042.10 | 1041.62 | 1039.43 | 1038.63 | 1036.18 | 1038.77 | 1038.77 |
| Water Level Difference | (m) | 0.72 | -0.38 | -0.37 | -0.29 | -0.27 | -0.45 | 1.23 | -0.10 | -0.64 | -1.34 | 0.18 | -1.45 |
| Storage Difference | (%) | 37 | -13 | -9 | -6 | -5 | -10 | 28 | -4 | -30 | -201 | 8 | -69 |

Notes:

1. Pumping data for Pumps 947/948/949/950/952 are not reliable between April 5 to August 15, 2017 due to a faulty flow metre.
2. Cells shaded in purple indicate that the pumped flow volume is likely too high. The orange shading indicates that the volume is likely too low. This is based on the differences between observed and calculated storage and water levels.
3. ARDWU = weir at toe of South Dike near abutment.

3.3 Freeboard and Storage

ARD Pond

The MOL of the pond is set at 1046.5 m, which is 0.9 m lower than the spillway crest (1047.4 m). It allows for a storage depth of 0.6 m for a 48 hour Probable Maximum Flood (PMF) and 0.3 m for a 1:100 year significant wave run-up. The elevation of top of the dam is set at 1048.0 m, providing a vertical distance of 0.6 to the spillway crest. The distance is designed for a flow of 0.3 m deep and a freeboard of 0.3 m (KCB 2000).

The stage–storage curve of the pond is shown on Figure XII-3, and its key design and performance characteristics are provided in Table 3.4. Quantifiable Performance Objectives (QPOs) have been developed with respect to the available freeboard for the ARD Pond. The QPOs are discussed in Appendix III and the threshold values are provided in Table AIII.4 of Appendix III.

Table 3.4 Relevant ARD Pond Characteristics

| Item | Value |
|---|---------|
| Top of the Dam Elevation (m) | 1048.0 |
| Spillway Crest Elevation (m) | 1047.4 |
| Maximum Operating Level (m) | 1046.5 |
| Storage Capacity at the MOL (m ³) | 710,700 |
| Designed Storage Capacity for PMF (m ³) | 50,000 |
| Designed Freeboard for PMF (m) | 0.3 |
| Minimum Water Level in 2016-2017 (m) | 1035.7 |
| Maximum Water Level in 2016-2017 (m) | 1044.6 |
| Maximum Storage in 2016-2017 (m ³) | 527,700 |
| Minimum Storage Available in 2016-2017 to reach MOL (m ³) | 173,800 |

ESP

The ESP is intended for emergency storage when the capacity of the ARD Pond is exceeded. Available documentation does not define an MOL for the ESP.

Hydrologic modelling was conducted by KCB (2011) assuming that the starting water level in the pond was at elevation 1038 m and pumps 905/906 are pumping to the ARD Pond at a capacity of 7500 l/min. The modelling indicated that the ESP has sufficient capacity to completely contain a 1:1,000 year, 10 day summer rainfall event and still provide 1 m of freeboard to the spillway crest. However, spring events that include a snowmelt component were found to be much more severe than summer rainfall events. A 1:100 year snowmelt, or a 1:100 year rainfall on average snowpack, were expected to result in some spill. Subsequent experience suggests that the 2011 modelling was likely conservative. This work is to be reviewed and updated in 2018.

The spillway is designed to safely pass the PMF. The stage – storage curve of the pond is shown on Figure XII-4, and its key design and performance characteristics are provided in Table 3.5. QPOs have also been developed with respect to the available freeboard for the ESP. The QPOs are discussed in Appendix III and the threshold values are provided in Table AIII.4 of Appendix III.

Table 3.5 Relevant ESP Characteristics

| Item | Value |
|--|---------|
| Top of the Dike Elevation (m) | 1042.0 |
| Spillway Crest Elevation (m) | 1041.0 |
| Designed Storage Capacity up to the Spillway (m ³) | 380,200 |
| Minimum Water Level in 2016-2017 (m) | 1036.5 |
| Maximum Water Level in 2016-2017 (m) | 1038.8 |
| Maximum Storage in 2016-2017 (m ³) | 67,100 |
| Minimum Storage Available in 2016-2017 to reach the Spillway (m ³) | 319,200 |

3.4 Water Discharge Volumes

There were no discharges over the spillways. The only discharge to the environment is treated water from the water treatment plant, which enters St. Mary River. Table 3.6 provides a summary of the monthly discharge volumes. There was a total discharge volume of 2,994,328 m³ between October 2016 and August 2017.

Table 3.6 Summary of Discharge to St. Mary's River

| Month | Total Volume (m ³) | Approximate Discharge per Day (m ³) |
|---------------|--------------------------------|---|
| October 2016 | 277,929 | 5,876 |
| November 2016 | 0 | 8,965 |
| December 2016 | 0 | 0 |
| January 2017 | 0 | 0 |
| February 2017 | 0 | 0 |
| March 2017 | 353,532 | 0 |
| April 2017 | 691,540 | 11,404 |
| May 2017 | 723,269 | 23,051 |
| June 2017 | 504,562 | 23,331 |
| July 2017 | 355,803 | 16,819 |
| August 2017 | 87,713 | 11,478 |
| Total | 2,994,328 | |

The discharge volumes are all less than the maximum limits provided in the effluent permit PE 00189.

3.5 Water Discharge Quality

KCB does not assess water quality. Teck reports groundwater quality and discharge water quality to BC Ministry of Environment as specified in Permit P6742.

4 SITE OBSERVATIONS

4.1 Visual Observations

The on-site inspection of the dikes was carried out by Mr. Ward Algar, P.Eng, and Engineer of Record, Ms. Karen Masterson, P.Eng, of KCB from May 10 through May 11, 2017. The weather during the inspection was a mixture of clear and cloudy skies, with periods of heavy rainfall. The 2017 Dam Safety Inspection Forms that were completed for each dike are included in Appendix I and selected photographs from the site visit are included in Appendix II. A summary of the visual observations of each dike is provided below:

Iron Pond (ESP)

The visual inspection of the Iron Dike indicated that the dike was in good condition with no signs of structural distress. No cracking was noted along the crest or downstream slopes. Dike slopes and crests are grassed with no areas observed with bare or loose soil.

Seepage is occurring on the downstream side of the dike near station 5+00. The seepage is currently being monitored by two weirs (Weir #4 and Weir #3 – AIPWU) installed within the drainage ditch (Appendix II Photos 1.13 through 1.17). The locations of these weirs are shown on Figures 3 and 4, respectively. Seepage is also occurring on the downstream side of the dike near station 24+00 and is being collected in the existing ditch and low-lying area (Appendix II Photo 1.02). This seepage should continue to be monitored.

The visual inspection of the Emergency Storage Pond (contained within Iron Pond) indicated that it was functioning as intended.

The Emergency Spillway Channel at the west side of the West Gypsum pond appears to be in good condition. Some vegetation is evident near the low point of the spillway, located near the 951 Pump House (Appendix II Photo 9.06).

Old Iron Pond

The Southwest Limb (SWL) and Southeast Limb (SEL) of the Old Iron Pond appear to be performing as intended with no signs of cracking or distress. Dike slopes of the SWL are grassed with no areas of bare or loose soil. There were no signs of seepage. The SEL is buttressed by the Iron Pond and is currently being used as an access road between the two ponds. No changes were observed from the previous DSI.

Siliceous Pond #1, #2, and #3

The dike surfaces were found to be in good physical condition, with no visible signs of structural distress at the time of the inspection. Seepage of variable amounts generally occurs from the toes of all the Siliceous Dikes during the spring runoff due to snowmelt water infiltration through the cover system. The seepage water is collected by drainage ditches. Inspection of seepage locations along the Siliceous Dikes is performed by Teck on a routine basis. During the inspection seepage was

observed entering the seepage collection ditch near the west end of the #2 Siliceous dike (Appendix II Photo 4.05).

The surface water runoff channel from Siliceous Pond No. 1 across Pond No. 3 (Appendix II Photos 4.13 and 4.14), the diversion channel to the North of Ponds No. 1 and No. 3 (Appendix II Photos 4.01), and the riprapped emergency spillway channel (Appendix II Photos 4.10 and 4.12) constructed down the slope of Siliceous Pond No. 3 were in good condition during the time of the site visit.

West Gypsum Pond

The West Gypsum Dike appears to be in good condition based on a visual assessment with no indication of structural distress. The ditches that convey seepage from the dike toe to the pond at the 951 Pump House were well maintained. Water was not observed within the ditches near the dike toe (Appendix II Photo 5.03). Rodent burrows were observed near the middle and west of the dike toe (Appendix II Photo 5.05). These burrows are currently not considered a dam safety issue.

East Gypsum Pond

The East Gypsum Dike was observed to be in good physical condition during the inspection. Dike slopes are grassed with no areas of bare or loose soil observed. No indicators of erosion or structural distress were found. Large rodent burrows (most likely badger) were observed along the toe of the East Gypsum Dike but are currently not considered a dam safety issue (Appendix II Photos 5.18, 5.19 and 5.22). Seepage was observed within the ditch at the dike toe (Appendix II Photo 5.16). There were also seepage flows through James Creek coming from the east abutment where a filter was constructed in 2002 to collect seepage and from the toe ditches (Appendix II Photo 5.15). The observed seepage was similar to previous DSI site visits.

Northeast Gypsum Dike and Recycle Dam

Both the Northeast Gypsum Dike and Recycle Dam embankments appear to be in good condition, with no signs of structural distress observed along the crest. The slopes of both embankments are grassed and in good condition, however there is some evidence of minor surficial erosion (Appendix II Photo 5.33) along the slope of the Northeast Gypsum dike due to run-off.

ARD Pond

The visual inspection of the North and South Dams of the ARD pond did not reveal any evidence of problems with the integrity of the dams. The riprap on both dams was in good condition with no evidence of beaching or damage. It was noted that the debris build up in the ditch located to the north of the North Dam had been removed and continues to appear in good condition (Appendix II Photos 6.15 and 6.18).

The downstream slope of the North Dam appears to be in similar conditions to previous years. Localized depressions/steepened slopes along the toe of the north dam have been noted during the annual inspections (Appendix II Photo 6.19). These areas are not considered to be dam safety issues. Seepage collects in the toe ditch and flows to the seepage pond at the west end of the dam.

The ditch south of the South Dam that feeds into Weir #1 (ARDWU) and Weir #2 had a buildup of algae which was potentially impeding flow (Appendix II Photo 6.07). Subsequent to KCB's site visit the algae was cleared. The locations of the weirs are shown on Figure 16. The downstream slope of the South Dam appeared to be in similar condition to past inspections. Wetlands vegetation was observed in the ditch by the access road (Appendix II Photo 6.10). The seepage zone near piezometer SD-02, which is captured with a gravel blanket, feeds the toe ditch (Appendix II Photo 6.08). Flows within the toe ditch appear to be similar to previous years and is clear with some algae growth.

Calcine Pond

The Calcine Dike remains in good physical condition and there were no obvious changes relative to previous inspections. The downstream slope of the dike is well vegetated and is buttressed by a municipal landfill. Monitoring of the Calcine Dike should remain as an annual visual inspection.

The old beach surface is at crest level adjacent to the dike, and gently slopes downward towards the north. There was no free water observed during the inspection, and vegetation has become established over the entire upstream and downstream area. Calcine removal from a pit developed at the northwest side of the lower pond ceased in 2011/2012 and this area was reclaimed. The pit is well drained and no standing water was observed (Appendix II Photos 7.01 and 7.02).

Sludge Pond

The visual inspection indicated that the structures remain in good condition. The sludge level is low within the pond. A slight depression was observed near the east end of the north dike as well as the south end of the south dike. These depressions in the crest align with the locations of the access ramps.

4.2 Photographs

Selected photographs of the various embankments taken during the site visit are presented in Appendix II and are referenced throughout this report. Photographs have been grouped as follows:

- Iron Pond 1.01 - 1.17
- Emergency Storage Pond 2.01 - 2.04
- Southwest Limb of Old Iron Pond 3.01 - 3.05
- Siliceous Ponds 4.01 - 4.19
- Gypsum Ponds/Recycle Pond 5.01 - 5.35
- ARD Pond/ARD Spillway 6.01 - 6.30
- Calcine Pond 7.01 - 7.05
- Sludge Pond and Treatment Plant 8.01 - 8.12
- Emergency Storage Pond Spillway 9.01 – 9.07

Aiming positions/locations for the photographs are shown on Figures 3, 4, 6, 8, 10, 12, 14, 16, 18, and 20 for each mine tailings area separately. Captions are included with the photos where appropriate.

4.3 Instrumentation Review

Quantifiable Performance Objectives (QPOs) have been established for the instrumentation installed within the dikes/dams including pond water levels for the ARD Pond and ESP (Iron Pond). These QPOs will be/are currently included in the OMS Manual. Those QPO's not currently in the OMS Manual will be added in 2018. The QPOs for the instrumentation and water levels are provided in Appendix III as well as tables (AIII-1 through 3), summarizing the piezometer, settlement and seepage data along with threshold levels for the instruments.

The precipitation data for Kimberley/Cranbrook indicated higher than normal rainfall (Fall 2016) as well as snowfall (winter 2017) for the reporting period as compared to 2009 through 2011 and 2014 through 2016. As occurred during the wetter years in 2012 and 2013, piezometric levels generally indicated an increase. This response is expected and piezometric levels tend to decrease during the drier summer months. Attached in Appendix III (Figure AIII-1) is a summary plot of precipitation data for reference.

A review of the current threshold levels will be completed in 2018, which will also incorporate a second threshold level for the piezometric data.

4.3.1 Iron Pond Dike (ESP)

The locations of the existing instruments at the Iron Dike are shown on Figure 4. Typical sections showing geometry and pore pressure response are shown on Figure 5.

Water Levels

Time plots of the piezometric readings received from Vast are presented on Figures IV-1 through IV-9 in Appendix IV. Peak values are reported in Table AIII.1 and shown on Figure 4.

Most of the Iron Pond Dike piezometers (22 of 30) indicated an increase in in the measured pore pressures during the 2017 reporting period over the previous year's readings. However, all of the readings were below the threshold levels and well below levels assumed for design stability assessments. In general, the instruments in the area have all shown expected responses based on increased higher than average precipitation observed in the fall/winter of 2016/2017.

There are two piezometers that were installed within a confined aquifer below the dike (P92-H and P92-25). Previous DSI's discuss the history of these two instruments as P92-H was experiencing erratic readings and high pore pressure readings near trigger levels. The threshold levels were adjusted, and P92-H was remediated by installing a vibrating wire piezometer within the existing standpipe. Since then, the readings collected have indicated that pore pressures have stabilized.

Deformation/Settlement

Of the five settlement plates being monitored, four plates on the south side (upstream of the dike crest, between stations 2+00 and 9+00) indicate settlements have stabilized with between 45 and 65 mm of total settlement since 2007. The SP92-07 plate on the 1033.0 m bench, downstream side, has indicated settlement of approximately 31 mm since 2007, with no change since 2015. As settlement is essentially zero, it is well within threshold limits.

In addition to the settlement plates, it is recommended that a survey of the dam crest be performed in the area surrounding the ESP spillway approximately every 3 years. While the settlement plates indicate minimal settlement, portions of the dike crest are used as access roads and maintenance activities may alter the elevation of the dike crest. The LiDAR information received in 2012 indicated crest elevations were at or above required design elevations. The 2016 DSI recommended surveying the dike crest between Stations 0+00 and 14+00. A survey was performed in 2017 and indicated the dike is at or above the design elevation of 1042 m.

Seepage Flows

Two weirs (Weir #3 – AIPWU and Weir #4) exist to monitor seepage from the toe of the west portion of the iron dike. Weir #3 is located near the toe of the Dike, and Weir #4 is located 300 m downstream.

Weir #3 - AIPWU (Figure IV-10) measured peak flows of 61.3 m³/day in March. The flow data indicate minimum flows through Weir #3 (AIPWU) are 2.3 m³/day and 6.3 m³/day. The peak flows were higher in 2017, however this is expected due to the greater snowpack. As this weir was installed in 2013 at the start of a drier period there is no historical comparison. It should be noted that while it is installed close to the dike toe, there will still be some effect due to run-off from the dike.

Data for Weir #4 has been collected since 2008 and the trend is presented on Figure IV-11. The flow data generally indicates maximum flows of about 200 to 250 m³/day every year, with higher flows during wet years. In 2017 a peak flow of 688.5 m³/day was recorded in April. This reading is substantially higher than the peak of 2016 due to increased precipitation. A similar peak was observed in 2012 during a year of high precipitation. It should be noted that this weir is 300 m from the dike toe at station 5+00 and flow measurements will also include surface run-off from the surrounding terrain as well as any seepage collected.

The weirs should be read at a minimum monthly, with weekly readings performed during spring freshet and additional readings following heavy rainfall events.

4.3.2 Old Iron Pond Dikes

The locations of the existing instruments at the Old Iron Pond Dikes (SW and SE Limbs) are shown on Figure 6. A typical section showing geometry is shown on Figure 7.

Water Levels

Plots of the piezometer readings for the Old Iron Pond Dikes are included as Appendix V. Southwest Limb piezometers are shown on Figures V-1 and V-2, and the Southeast Limb piezometers are shown on Figure V-3. Peak values are reported in Table AIII.1 and shown on Figure 6.

All six of the piezometers currently being monitored within the area of the Old Iron Pond Dike indicated increases in pore pressure readings when compared to the previous reporting period. Three of these piezometers (P93-17, P93-18 and P96-08) indicated maximum measured pore pressures above current threshold levels, however the most recent readings have shown a decrease with P93-17 and P93-18 below trigger levels. The increase is most likely due to the higher than average rainfall and snowpack observed in the fall of 2016 and winter of 2017. These piezometers will continue to be

monitored closely to confirm that pore pressures continue to dissipate. The measured pore pressures are all below the assumed piezometric surface used for design.

The 2016 DSI recommended the replacement of piezometer P96-11 as this instrument is critical for monitoring water levels within the float rock berm. The piezometer is scheduled to be replaced in 2018. Additionally, piezometer P96-08 should be replaced as the tip elevation is unknown and the readings only provide relative change in elevation. This piezometer has also started to indicate erratic readings.

4.3.3 No. 1, 2, and 3 Siliceous Pond Dike

The locations of the existing instruments at the Siliceous Ponds are shown on Figure 8. Typical sections showing geometry and pore pressure response are shown on Figure 9.

Water Levels

No. 1 Dike

Time-history plots of piezometer readings for the No.1 dike are presented on Figures VI-1 to VI-3 in Appendix VI. Peak values are reported in Table AIII.1 and shown on Figure 8.

There are currently five piezometers for Siliceous Pond Dike #1 that are providing data. Of these, all except for SP101 experienced an increase in the maximum recorded pore pressures in comparison to the previous year, which is expected due to the increased precipitation. P105 is above the threshold level, however, this is still below the piezometric surface assumed for design. A review of the threshold level should be completed to assess if the levels account for increases due to higher precipitation values.

No. 2 Dike

A time-history plot of the piezometer data for the No. 2 dike is included as Figure VI-4 in Appendix VI. The only active piezometers in the area are P231 and P257, which have both shown an increase in comparison to 2016 readings as expected based on the increased precipitation. While the piezometer readings have increased, they are below the threshold levels.

No. 3 Dike

A time-history plot of the piezometer data for the No.3 dike is included as Figure VI-5 in Appendix VI. There are currently five functioning standpipe piezometers along the No. 3 Siliceous Dike alignment which are read annually.

Of the five piezometers read in 2017, two of them, P302 and P303, were dry, while both P232 and P233 reported no change from last year, and P301 reported a 1.5 m increase in maximum pore pressure reading to a level above the threshold level. An additional reading was requested and indicated the standpipe was dry. Based on the new reading, the recorded increase of 1.5 m was most likely due to a clerical error when recording the water level.

There are three piezometers which should be replaced in 2018, as due to sediment build-up within the standpipes, the bottom depths are now at or above the phreatic surface assumed for design. These piezometers are P301, P302 and P303.

4.3.4 West Gypsum Pond Dike

The locations of the existing instruments at the West Gypsum Pond are shown on Figure 10. A typical section showing geometry and pore pressure response is shown on Figure 11.

Water Levels

Plots of piezometer data are enclosed as Figure VII-2 and Figure VII-3 in Appendix VII. Currently there are six active piezometers along the West Gypsum Pond Dike. Of these, five are showing an increase in maximum recorded pore pressure in comparison to last year most likely due to higher than average precipitation and snowpack during the reporting period. Instrument P93-7 was reported as dry. All readings show pore pressures greater than 3m below the specified threshold levels and the phreatic surface assumed for design. All active piezometers should continue to be read three times per year at the West Gypsum Dike.

Deformation/Settlement

The three settlement plates remaining at the West Gypsum Dike are surveyed in three directions. The plots of their displacements are provided on Figures VII-4 to VII-6 in Appendix VII.

Settlement plates SP97-01 and SP97-05 are located at Station 10+00. SP97-01 on the downstream side of the dike has settled about 275 mm and displaced horizontally, in the upstream direction, about 305 mm since installation in 1997. The data indicates the settlement started to stabilize in 2004, with a settlement of approximately 7 mm recorded since last year. SP97-05 on the upstream side of the dike has settled about 950 mm and moved upstream about 175 mm since installation. It has continued to settle at a relatively constant rate of about 30 to 50 mm/year since 2004, with a settlement of 37 mm recorded since last year.

Settlement plate SP97-06 is located at Station 20+00 on the upstream side of the dike. It has recorded about 575 mm of settlement and about 95 mm of horizontal upstream displacement since installation in 1998. It has been settling at an approximate rate of about 20 to 30 mm/year since 2004, with a settlement of 19 mm recorded since last year.

Continued settlement of the dike crest is expected as continued creep is common in gypsum and the dike was constructed using the upstream method, i.e., dike raises are founded on Gypsum. The measured settlement is below the threshold limits and is expected to continue. It is not a dam safety concern.

Consolidation of the West Gypsum Pond tailings is monitored with Sondex multiple settlement gauge S94-01, installed about 50 m upstream of the crest at Station 10+00 (Figure VII-1 in Appendix VII). A reading of the Sondex gauge was taken during the 2016 site visit. The reading schedule for this gauge was changed to every three years in 2012, however was not read in 2015 due to equipment errors. The next reading is scheduled for 2019. The Sondex gauge has a current settlement rate of 30 mm/year (top ring) since 2008 with a total settlement of about 1.6 m since 1994. The settlement

rate has not leveled off to date. As indicated in KCB's report Stability Review of Gypsum Dikes dated November 26, 1993, long term creep is a common characteristic of Gypsum.

A survey of the dike crest was completed in 2017. A comparison of the results with the 2012 LiDAR indicates approximately 0.2 m of settlement, which is to be expected for an upstream dike constructed over gypsum and is not a dam safety concern. A review of the hydrology design to be completed in 2018 will assess the effects of the settlement to hydrologic performance of the dike and whether additional fill is required on the dike crest.

Stability/Lateral Movement

Inclinometer BI94-01 at Station 10+00 has not been read since 2004 as it is blocked 4.7 m below the ground surface. This is likely due to cumulative and continuing upstream movement occurring at this depth combined with the ongoing settlement. It is not necessary to replace this instrument, based on the movement trends observed and there is sufficient instrumentation to adequately monitor potential slope deformations in this area. It may only be necessary to replace BI94-01 if visual observations and/or the other instruments indicate adverse deformation patterns.

Figure VII-1 in Appendix VII shows the cumulative deflection up to 2004 as well as readings of the upper 4.7 m taken in 2007 through 2009. The 2007 through 2009 data were merged with the 2004 data below 4.7 m to observe any potential movement at the top of the casing. No additional movement at the top of the casing was observed and this inclinometer is no longer read.

4.3.5 East Gypsum Pond Dike

The locations of the existing instruments at the East Gypsum Pond are shown on Figure 12. A typical section showing geometry and pore pressure response is shown on Figure 13.

Water Levels

Plots of piezometer readings are provided in Appendix VIII (Figures VIII-2 and VIII-3). Currently there are seven active piezometers installed along the East Gypsum Pond Dike. Of these, five are showing an increase in maximum recorded pore pressure in comparison to last year most likely due to higher than average precipitation and snowpack during the reporting period. Instrument P93-14 was reported as dry. All readings show pore pressures below the specified threshold levels and below the level assumed in the stability analyses.

All active piezometers should continue to be read annually at the East Gypsum Dike.

The groundwater levels in the East Gypsum Pond are generally higher than in the West Gypsum Pond.

Deformation/Settlement

Two active settlement plates at the East Gypsum Dike are surveyed in three directions. The plots of their displacements are provided on Figures VIII-4 and VIII-5 in Appendix VIII.

Settlement plate SP97-03 is located at Station 33+00 on the downstream side. It has settled about 600 mm and displaced horizontally, in the upstream direction, about 95 mm since installation in 1998. Settlement plate SP97-04 is located at Station 48+00 on the downstream side. It has recorded

about 505 mm of settlement and about 125 mm of horizontal upstream displacement since installation. Both plates continue to settle at a uniform rate of about 20 mm/year to 30 mm/year, with recent readings of 23 mm (SP97-03) and 16 mm (SP97-05) in comparison to last year's readings. The horizontal displacements are occurring at a rate of approximately 10 mm/year, and are directed upstream, perpendicular to the dike crest. The settlement is below threshold values and is expected as gypsum continues to settle for many years following deposition.

Consolidation of the East Gypsum Pond tailings is monitored with the Sondex settlement gauge S94-02, installed about 25 m upstream of the crest at Station 33+00 (Figure VIII-1 in Appendix VIII). The reading schedule for this gauge was changed to every three years in 2012, however was not read in 2015 due to equipment errors but read in 2016 instead. The next reading is scheduled for 2019. The Sondex gauge has a current settlement rate of 40 mm/year (top ring) since 2008 with a total settlement of about 940 mm since 1994. The settlement rate has not leveled off to date. As indicated in KCB's report Stability Review of Gypsum Dikes dated November 26, 1993, long term creep is a common characteristic of Gypsum and is not a dam safety concern.

A survey of the dike crest was completed in 2017. A comparison of the results with the 2012 LiDAR indicates approximately 0.5 m of settlement, which is to be expected for an upstream dike constructed over gypsum and is not a dam safety concern. A review of the hydrology design to be completed in 2018 will assess the effects of the settlement to hydrologic performance of the dike and whether additional fill is required on the dike crest.

Stability/Lateral Movement

There is one inclinometer (BI94-02) installed within the East Gypsum Pond Dike at Station 33+00. There has been very little horizontal movement (<10 mm) indicated since 2010. The BI94-02 readings are presented on Figure VIII-1. This inclinometer was not read in 2017 as the next reading is scheduled for 2019.

4.3.6 Northeast Gypsum Dike and Recycle Dam

A plan view of the Northeast Gypsum Dike and Recycle Dam are shown on Figure 14. A typical section showing geometry is shown on Figure 15.

Water Levels

There are four standpipe piezometers installed at the Northeast Gypsum Dike, and two standpipe piezometers installed at the Recycle Dam. Following the recommendations in the 2004 DSI, the piezometers are no longer being read as they essentially recorded the pond elevations and were not providing information to assess Dike/Dam performance.

Deformation/Settlement

Settlement of the Northeast Gypsum Dike is measured by plates W (S1) and E (S2) that indicate essentially no settlement since 2007 (See Appendix IX).

Stability/Lateral Movement

Lateral movement can be monitored from the survey of the settlement plates. There has been less than 20 mm of lateral movement observed since 2007.

4.3.7 ARD Pond Dams

The locations of the existing instruments at the ARD Pond are shown on Figure 16. Typical sections showing geometry and pore pressure response are shown on Figure 17.

South Dam

Water Levels

There are currently five active piezometers installed within the ARD South Dam, three of which are standpipes, and two are pneumatic. In general, the standpipes have all experienced increases in maximum recorded pore pressures since last year, whereas the pneumatic piezometers have recorded no change. Piezometers SD-01 and SD-02 exhibit direct response to changes in the reservoir elevation, while SD-03, PP01-05 and PP01-06 show weak response to the fluctuations of the reservoir elevation (Figure X-1 and X-2 in Appendix X).

The pneumatic piezometers in the middle section of the South Dam, PP01-05 and PP01-06, have recorded a stable groundwater elevation of about 1030 m since installation in 2002. PP01-06 recorded a maximum reading in April above the threshold level, however, the subsequent reading was below threshold level. Both standpipes SD-02 and SD-03 recorded maximum readings above their threshold levels, but are now well below the threshold levels. The threshold level was reached for one reading for these instruments which are read daily in the spring when piezometric elevations are at their peak. Reaching the current threshold level is not a dam safety concern as the design factors of safety are well above minimum requirements and the thresholds for the standpipes are currently set below the design piezometric assumptions, indicating higher piezometric surfaces will not impact dam safety. A review of the thresholds will be completed in 2018 such that they are set to more appropriate levels to account for years of higher precipitation and incorporate the high design factors of safety. Standpipe SD-01 continues to report maximum values well below the threshold level, which is consistent with previous years, however, fluctuates up to 5 m each year with pond level changes. SD-01 typically indicates a greater response when the pond water level exceeds 1041 m.

Deformation/Settlement

Settlement plates SP4, SP5 and SP6 at the South Dam have recorded no measurable settlement since 2001 (Figure X-7 in Appendix X), indicating the dam is performing as intended.

Stability/Lateral Movement

Lateral movements can be monitored through survey of the settlement plates. There has been less than 25 mm of lateral movement recorded by the survey.

Seepage Flows

There are currently two weirs installed to measure seepage at the South Dam toe, although runoff from the dikes and surrounding terrain is also captured. These include Weir #1 (ARDWU) installed in 2013, and Weir #2 approximately 50 m downstream. In 2017 readings obtained for Weir #1 - ARDWU (Figure X-5 in Appendix X) indicate similar trends to Weir #2 (Figure X-6 in Appendix VIII). The peak measured flows for the reporting period were 202.0 m³/day and 241.2 m³/day, respectively. The locations of Weir #1 (ARDWU) & Weir #2 are shown on Figure 16.

South Dam Weir #2 flows show a correlation to the water levels in the reservoir, with almost no flow recorded until the pond elevation exceeds elevation 1036 m. Higher than typical flows were recorded in 2012/2013 as well as last year due to the melting of a larger snowpack, and increased rainfall during the spring.

South Dam Weir #1 (ARDWU) also indicates higher than average flows for 2017. Weir ARDWU shows similar annual trends as Weir #2, i.e. low to no flow when pond is below El. 1036 m.

It should be noted that there is no significant weir flow as long as the pond level is below 1040 m (Figures X-5 & 6 in Appendix X), which also corresponds to the lower precipitation in the summer months.

North Dam

Water Levels

There are currently eight active piezometers installed within the ARD North Dike, four of which are standpipes, and four are pneumatic. All of the standpipes recorded increases in maximum recorded pore pressures since last year, with only one (ND-02S) recording a value higher than the threshold level. Recent readings for this instrument are showing values below the threshold. A review of the threshold levels will be completed in 2018. As is the case for the South Dam, the thresholds are below design assumptions and the design factors of safety are well above minimum requirements, indicating a higher piezometric surface would not impact dam safety. Two of the four pneumatic piezometers also recorded increases, while the other two recorded decreases since previous readings. The increase in maximum readings is expected as the precipitation was higher than average.

Standpipe piezometers ND-01, ND-02D, ND-02S and ND-03, located along the downstream dam toe, all respond to the reservoir level changes. The maximum groundwater levels measured are between 1041.4 m on the east side and 1038.8 m on the west side, about 2 m to 3 m below the surface, and with a general gradient toward the seepage collection pond (Figure X-3 in Appendix X). Pneumatic piezometers PP01-01 to PP01-03, along the North Dam crest, have been measuring essentially zero pressure since their installation in 2002 (Figure X-4 in Appendix X). This is not unexpected since the tip elevations are either at or above the groundwater level measured by nearby standpipes.

Deformation/Settlement

Similar to the South Dam, settlement plates SP1, SP2 and SP3 at the North Dam have recorded a total settlement of less than 20 mm since installation in 2001 (Figure X-8), indicating the dam is performing as intended.

Stability/Lateral Movement

Lateral movements can be monitored through survey of the settlement plates. There has been less than 25 mm of lateral movement recorded by the survey.

4.3.8 Calcine Pond Dike

A plan view of the Calcine Pond Dike is shown on Figure 18. A typical section showing geometry is shown on Figure 19.

Water Levels

Three standpipe piezometers are located on the dike crest as shown on Figure 18 (C1, C2 and C3). The piezometers were last inspected in June 2004, and have been dry since 1986. As per KCB's recommendation, piezometer monitoring at the Calcine Pond Dike ceased in 2007.

4.3.9 Sludge Pond Dikes

A plan view of the Sludge Pond Dikes is shown on Figure 20. A typical section showing geometry is shown on Figure 21.

Water Levels

There is no instrumentation installed to monitor water levels as there is no water stored within the pond. Water deposited during sludge deposition or due to precipitation drains through the embankment (contains a filter zone) and into the foundation.

Deformation/Settlement

Surveys of the Sludge Pond Dike Crests (North and South Dikes) were taken twice in 2017 to monitor any settlement that is occurring and to compare the crest elevations to the design elevation of 894.6 m.

The most recent survey from September 2017 can be found on Figure XI-1. The survey indicates that the most southern portion of the South Dike crest is currently below the design elevation by approximately 0.5 m as a result of the access ramp cutting into the crest. There is a similar issue at the east end of the North Dike, however the design elevation was met, but not the crest width. The access ramp at the North Dike was adjusted in Fall 2017, such that the required crest width is now per design.

The surveys indicate that there has been no settlement. A survey of the dike crest is only required once per year unless visual inspections indicate otherwise.

General

Based on the review of the instrumentation data, there are no dam safety concerns. The recommended monitoring schedule for the all instruments will not change for the 2018 DSI reporting period. The monitoring frequencies are reported below in Table 4.1 below. Additional readings may be requested as required depending on trends observed during the 2018 reporting period.

Table 4.1 Monitoring Frequencies for 2018

| Dike/Pond | | Monitoring Frequency (3x = Three times per year, 3y = Every 3 years, A = Annual, AV = Annual Visual, M = Monthly) | | | | |
|--|------------|--|-----------------------|-------------------|-----------------------------------|--------------|
| | | Piezometers | Settlements | Inclinometers | Seepage | Water Levels |
| Iron Pond Dike | | 3x ^(1,9) | 3y ⁽⁷⁾ | - | M + special regime ⁽⁸⁾ | Daily |
| Old Iron Pond | SW Limb | 3x ⁽¹⁾ | - | - | - | - |
| | SE Limb | A ⁽²⁾ | - | - | - | - |
| Siliceous Pond Dikes #1, #2 and #3 | | A ⁽⁶⁾ | - | - | - | - |
| Gypsum Pond Dikes | West | 3x | A + 3y ⁽⁷⁾ | - | AV ⁽⁴⁾ | - |
| | East | A | A + 3y ⁽⁷⁾ | 3y ⁽⁷⁾ | AV | - |
| Northeast Gypsum Dike and Recycle Pond | | - | 3y ⁽⁷⁾ | - | - | - |
| ARD Pond | North Dam | 3x + special regime ^(3,10) | 3y ⁽⁷⁾ | - | - | Daily |
| | South Dam | 3x + special regime ^(3,10) | 3y ⁽⁷⁾ | - | M + special regime ⁽³⁾ | |
| Sludge Pond | North Dike | - | A | - | - | - |
| | South Dike | - | A | - | - | - |

Notes:

1. Three times a year (spring, summer and fall).
2. Annually in the spring if possible as this will be peak level.
3. Special regime: Weirs and standpipe piezometers weekly when ARD Pond levels are above 1040 m and daily when ARD Pond levels are above 1045 m. Record pond water levels when weirs read. When reading weirs, provide visual observations of ditch flows, i.e., ice build-up upstream of weir, flows under or around weir, etc.
4. Annually, visual inspection.
5. Only read standpipe piezometers.
6. At a minimum only required to read piezometers P5 and P105 in Siliceous Pond Dike #1; P231 and P257 in Siliceous Pond Dike #2; and, P232, P301 and P303 in Siliceous Pond Dike #3.
7. Settlement plates to be read annually. Inclinometer and Sondex gauges to be read every three years
8. Special regime: Weir #3 (ARDWU) should be read at a minimum weekly during Spring freshet and following severe rainfall events. Record pond water levels when weirs read. When reading weirs, provide visual observations of ditch flows, i.e., ice build-up upstream of weir, flows under or around weir, etc.
9. Three times a year (spring, summer and fall) except P92-H which is recorded weekly by a data logger and P92-02 and P92-25 are read monthly.
10. Read pneumatic piezometers three times per year and daily when pond is above 1045 m.

5 DAM SAFETY ASSESSMENT

5.1 Design Basis Review

5.1.1 Geotechnical

From 1992 through 1994, KCB (EoR firm) completed stability assessments for all of the tailings dikes (except for ARD Pond dams (constructed in 2001)), Calcine dike, Sludge Pond dikes, and Northeast Gypsum and Recycle dams). This work included field investigation programs, laboratory testing and material parameter reviews. The KCB report “Geotechnical Design Basis for Tailings Dikes – Overview Summary Report” dated January 9, 2002 provides an overview of this work as well as the construction history and geotechnical design basis adopted for long term stability of the tailings dikes. Loose, saturated tailings, such as those present at the Sullivan Mine, are known to be susceptible to liquefaction whereby the tailings can suffer significant loss of strength when excessively high pore pressures are generated during undrained loading conditions. The structures at Sullivan Mine have been designed for the Maximum Credible Earthquake (MCE), which is the event that is thought to produce the highest expected seismic loading possible at the site. For the long-term static stability of the dikes, the minimum target factor of safety is 1.5 (same as current design criteria). For seismic stability with liquefaction of tailings, the minimum target factor of safety is 1.1 (standard of practice at time of closure). To enhance stability and to meet these design criteria, dike slopes were flattened and/or toe berms constructed.

As the most recent designs used the MCE for seismic loading cases (except for the sludge pond dikes), the minimum requirements of CDA 2007 with 2013 revision and HSRC (MEMPR, 2016 & MEMPR, 2017) have been met or exceeded based on the dike/dam consequence classification (refer to Table 5.2 for classification). Also, since the work done in the 1990s, the piezometric surfaces within the tailings ponds are lower and therefore the calculated factors of safety are higher, further enhancing stability for both seismic and static stability.

The ARD Pond Dams were also designed for the MCE (KCC 2000). For long-term stability, the minimum design factor of safety is 2.0 and, for rapid drawdown, 1.8. For seismic stability (pseudo-static screening), the minimum design factor of safety is 1.1 assuming 50% of the MCE for the seismic coefficient. The design meets all current required design criteria (MEMPR 2017).

As noted above, the geotechnical design of the sludge pond dikes was not reviewed in 2002 at closure. There was minimal sludge retained at that time and risk of failure was low. It was recommended that a review be performed in the future once sludge began to accumulate. There is currently still very minimal sludge deposited against the south dike, however, the sludge at the north dike is at the assumed design level (see Figure 20). The design report from 1978 indicated the dikes met a static factor of safety of 1.4 and seismic factor of safety (pseudo-static) of 1.2. A review of the stability of the dikes is warranted now that significant sludge is impounded against the north dike.

The Northeast Gypsum dike and Recycle Pond dike were also not reviewed prior to closure as the risk of failure was low and any release is contained within Teck’s property. These dikes were designed assuming a minimum static factor of safety of 1.5 and minimum seismic (pseudo-static) factor of safety of 1.3 (assumes 0.05 g). As both of these dams are low consequence dams and the design

factors of safety meet or exceed current guideline/regulatory requirements, there is no current requirement to review the stability.

The stability of the Calcine dike was not reviewed prior to closure, as following construction of the dike, a municipal landfill began operations downstream and provides a stabilizing buttress for the dike. Also, the original design assumed a pond was present, however piezometric levels are now close to original ground, enhancing stability. There is no concern for long-term stability.

5.1.2 Hydrology

The hydrologic design basis for the tailings facilities (except for the Sludge Pond) is described in the KCB report “Tailings Area Post-Closure Water Management Study – Final Report” dated January 3, 2001. The tailings facilities at the site were modified for closure and these closure designs used both Probable Maximum Flood (PMF)/ Probable Maximum Precipitation (PMP) flood events for water management assessments. The 2007 CDA (2013 Revision) and HSRC (MEMPR, 2016 & MEMPR, 2017) criteria stipulates that dams of very high consequence classification such as the ARD Pond dams (highest consequence classification) must be able to pass a flood 2/3 between the 1 in 1,000 year and the PMF. The other facilities have lower requirements. All of the dikes/dams at Sullivan Mine (except for the Sludge Pond) meet or exceed the guideline/regulatory requirements.

The Sludge Pond design assumed a design flood event of 1:200 year. The design also assumed a much faster sludge deposition than has actually occurred. It was assumed that the dikes would need to be raised and expanded well before closure. According to Teck, about 121,000 tonnes of sludge were deposited in the pond from October 1997 to December 2001. After the mine closure, from 2002 to 2009, only 21,941 tonnes of sludge were deposited in the pond. The following deposition occurred between 2010 to 2017:

- 2010 - 1,774 tonnes,
- 2011 - 3,917 tonnes,
- 2012 - 6,187 tonnes,
- 2013 – 5,555 tonnes,
- 2014 – 3,969 tonnes,
- 2015 – 1,810 tonnes,
- 2016 – 1,927 tonnes,
- 2017 – 4,388 tonnes (January – August 31)

A review of the sludge pond capacity was completed in 2015. It was estimated that the sludge pond could accommodate another 15 to 20 years of operation. However, with the recent changes to the HSRC requirements, the design flood event required for the sludge pond has increased and a review is required to assess if the current design freeboard is adequate to accommodate the new required design flood event of 1/3 between 1/975 and PMF. To facilitate the review, the sludge pond surface should be surveyed to obtain average sludge deposition rates.

5.2 Hazards and Failure Modes Review

As a required component of a dam safety inspection, the key potential hazards and failure modes must be identified. Failure at the tailings facilities can be defined as an uncontrolled release of tailings or ARD water to the environment. As the tailings and waste facilities are closed and have been reclaimed (except for the Sludge Pond, ARD Pond and Emergency Storage Pond), the key hazards and failure modes of concern are potential overtopping during major flood events for all ponds and piping failures (ARD Pond and Iron Pond (ESP)). Additional hazards include earthquake, slope instability and foundation stability.

The likelihood of overtopping failures is close to non-credible⁷ to very rare⁸ given the closure measures in place (e.g. drainage channels, spillways, etc. designed for PMF/PMP) for the Old Iron, Siliceous, Gypsum and Calcine Ponds. Spillways designed for the PMF/PMP are also in place for the ARD Pond and Iron Dike (ESP) such that the likelihood of overtopping is non-credible and close to non-credible, respectively. The likelihood of failure for overtopping of the sludge pond is unlikely⁹ based on the review of the storage capacity completed in 2015. The design criteria has changed and a review is to be completed in 2018 (see Section 5.1.2).

The likelihood for piping failures (ARD Pond and Iron Pond (ESP)) is also close to non-credible to very rare given the filter zones within the ARD Pond Dams and the low pond water levels and associated piezometric surfaces within the Iron Pond (ESP). The likelihood of a piping failure for the sludge pond is rare¹⁰ given the filter zone along the upstream face and lack of permanent pond.

In addition, Teck has a robust surveillance program to monitor pond levels and check for dike surface gullyng that might lead to freeboard changes, and to look for any evidence of changes in seepage conditions at the toe of each dike that could indicate potential piping (ARD Pond, Iron Dike (ESP) and Sludge Pond).

The likelihood of failure due to seismic and static instability (foundation and slope) is very rare to close to non-credible for the tailings facilities. As discussed in Section 5.1.1, stability assessments completed in the 1990s for the Iron Dike, Old Iron Dikes, Siliceous Dikes and Gypsum Dikes reviewed material parameter assumptions and considered the Maximum Credible Earthquake with all saturated tailings liquefying. To enhance stability, slopes were flattened and/or toe berms constructed. Since this work was completed, the piezometric levels within the dikes have decreased,

⁷ “Close to Non-Credible” Likelihood Rating is defined as: for a natural hazard (earthquake, flood, windstorm, etc.), the predicted return period for an event of this strength/magnitude is greater than 1 in 10,000 years; this rating is also applicable for failure modes such as instability and internal erosion. Factor of safety (FoS) for slope instability of 2.0 or greater.

⁸ “Very Rare” is defined as: for a natural hazard (earthquake, flood, windstorm, etc.), the predicted return period for an event of this strength/magnitude is between 1 in 1,000 and 1 in 10,000 years; this rating is also applicable for failure modes such as instability and internal erosion. Factor of safety (FoS) against slope instability of 1.5 to 2.0.

⁹ “Unlikely” is defined as: for a natural hazard (earthquake, flood, windstorm, etc.), the predicted return period for an event of this strength/magnitude is between 1 in 10 and 1 in 100 years; this rating is also applicable for failure modes such as instability and internal erosion. Factor of safety (FoS) against slope instability of 1.2 to 1.3.

¹⁰ “Rare” Likelihood Rating is defined as: for a natural hazard (earthquake, flood, windstorm, etc.), the predicted return period for an event of this strength/magnitude is between 1 in 100 years and 1 in 1000 years; this rating is also applicable for failure modes such as instability and internal erosion. Factor of safety (FoS) against slope instability of 1.3 to 1.5

further enhancing both static and seismic stability. Static factors of safety are well above 1.5. This would also be the case for the Calcine and Northeast Gypsum dikes as piezometric levels have also decreased.

Failures due to earthquake, slope instability and foundation instability are not considered credible failure modes for the ARD dams due to the assumption of MCE for seismic design and the resulting factors of safety, which are much greater than current design criteria.

The likelihood of failure due to seismic and foundation stability for the sludge pond is rare based on the design factors of safety of 1.2 and 1.4, respectively. As discussed in Section 5.1.1, a review of the stability is to be completed in 2018.

5.3 Review of Downstream and Upstream Conditions

There have been no changes to the downstream of the tailings facilities at Sullivan Mine. The town of Kimberley, B.C. (Marysville) located downstream of the facility has not experienced any major development or population changes.

The conditions upstream of the tailings facilities have also not experienced any changes that would require a reassessment of the failure consequence classification. There have been no changes to surface water run-off, watershed, or hydrology upstream.

5.4 Dam Classification Review

A review of the CDA guidelines was undertaken as part of the 2008 Dam Safety Review (KCB, 2009) and the 2013 Dam Safety Review (Golder, 2014), and based on the information available, the consequence of failure classification for the facilities at the Sullivan Mine is shown in Table 5.2. There have been no changes to the consequences of failure to warrant a change to the current dam classifications.

However, it is important to highlight that, while all of these structures are currently considered “dams” from a regulatory perspective, few of the inactive facilities are retaining fluid tailings and could be considered equivalent to earthen landfills. This is evident through a review of the instrumentation data which indicates piezometric surfaces for most which are very low (i.e. near original ground or 1 – 2 m above), especially for the Southeast and Southwest Limbs of the Old Iron Pond, the Siliceous Ponds, the Calcine Pond and the Gypsum Ponds. In such cases, their respective consequence classifications could be significantly lowered and, eventually, it may be possible to declassify some of these dikes in the near future. Teck and KCB are in the process of developing a phased work plan to support lowering the consequence classifications for some of the inactive facilities and towards eventual declassification of the dikes where considered feasible and appropriate.

Table 5.1 Consequence Classification

| Storage Facility | Embankment | Consequence Classification ¹ |
|------------------------------------|------------|---|
| Iron Pond (Emergency Storage Pond) | Iron Dike | H |

| Storage Facility | Embankment | Consequence Classification ¹ |
|------------------|-----------------------------|---|
| Old Iron Pond | Southwest Limb | L |
| | Southeast Limb | L |
| Siliceous Ponds | No. 1 Siliceous Dike | L |
| | No. 2 Siliceous Dike | L |
| | No. 3 Siliceous Dike | L |
| Gypsum Ponds | East Gypsum Dike | H |
| | West Gypsum Dike | H |
| | North East Gypsum Pond Dike | L |
| | Recycle Pond | L |
| Calcine Pond | Calcine Dike | L |
| Sludge Pond | North Dike | L |
| | South Dike | L |
| ARD Pond | North Dam | VH |
| | South Dam | VH |

Notes:

1. Consequence Categories based on 2007 Canadian Dam Safety Guidelines (CDA, 2013):
E=Extreme, VH= Very High, H=High, S=Significant, L=Low.

5.5 Physical Performance

5.5.1 Geotechnical

Iron Pond (ESP)

Based on the visual observations and instrumentation review, the stability of the Iron Dike is considered satisfactory. With the completion of the reclamation cover and a relatively constant phreatic surface, it is expected that the piezometric elevation within the Iron Dike will continue to stabilize.

Old Iron Pond

The monitoring data for the SW Limb found in Appendix V indicate the dike is performing as expected. Although the maximum measured phreatic conditions (recorded in Spring 2017) for some instruments were above threshold levels, subsequent readings in the summer and fall indicated lower a reduction in the piezometric levels to levels below the thresholds. The stability of the Southwest Limb is considered satisfactory.

Stability of the Southeast Limb is not a concern since it is buttressed by the Iron Pond immediately downstream.

Siliceous Ponds #1, #2 and #3

Based on the available monitoring data and observations made during the site inspection, the dikes are performing as intended.

West Gypsum Pond

Based on the visual inspection and available monitoring data, the dike is performing as intended.

The rodent burrows observed at the dike toe are not considered a dam safety related issue and were filled in following the inspection. The area should continue to be monitored for new activity.

East Gypsum Pond

A review of all relevant instrumentation data and observations made during the annual inspection indicate that the dike is performing as intended.

The rodent burrows observed during the site inspection are not considered a dam safety and were filled in following the site visit. The area should continue to be monitored for rodent activity.

Northeast Gypsum Dike and Recycle Dam

Both structures do not appear to be performing as intended based on the site inspection.

ARD Pond

Based on the review of all most recent instrumentation data and observations made during the annual inspection, the north and south dams are performing as intended.

Calcine Pond

Based on visual observations, the dike is performing as intended.

Sludge Pond

Based on the visual observations and the dike crest survey the dikes are performing as intended. However, the North Dike crest was narrower than required at the access ramp. This was rectified by regrading the ramp in Fall 2017. The South Dike crest was lower than the design elevation near the access ramp. The effect of this low spot and potential repair recommendations, if required, will be reviewed in 2018 as part of the recommended design review and storage capacity assessment (See Sections 5.1.1 and 5.1.2).

5.5.2 Hydrotechnical

The hydrotechnical performance of the tailings facilities are dictated by surface water flows and frequency of water discharge through existing spillways. During the current reporting period, there was no evidence of any issues related to surface water overtopping any of the existing dams or discharging into the emergency spillways for the ARD and ESP. The current condition of these spillways can be seen on photos 6.12 and 9.01 to 9.07. It was noted during the site inspection that

there is some growth of vegetation at the base of the ESP spillway channel to the west of the West Gypsum Pond Dike. This is shown in photo 9.06.

The sludge pond has performed as intended, and there is sufficient volume remaining within the pond to contain a 1:1,000 year flood event based on CDA Guidelines (2013 revision). As noted in Section 5.1.2, the design criteria based on HSRC (MEMPR 2017) requirements has changed, and a review of the available storage capacity is required.

5.5.3 Hydrogeological – Not Applicable

KCB does not review or monitor groundwater data. Groundwater monitoring data is reviewed by others and reported separately.

5.5.4 Geochemical – Not Applicable

KCB does not review geochemical data for Sullivan Mine. This information is reported separately by Teck.

5.5.5 Mechanical and Structural – Not Applicable

There are no mechanical or structural components to the dikes/dams at Sullivan Mine.

5.6 OMS Manual

The Operation, Maintenance and Surveillance (OMS) Manual for the Sullivan Mine Tailings facilities was updated in 2014 by Golder Associates. KCB annually updates the recommended instrument reading frequencies and trigger levels for the instruments as recommended in the DSI reports. An update of the OMS Manual was completed in Q1 2017 (V5 March 13, 2017) to address the following concerns from the 2016 DSI:

- The OMS Manual provides tables of required design criteria (CDA Guidelines, 2013), however the manual does not provide the design criteria used for each of the tailings structures.
- Some of the facility names used in the OMS Manual do not reflect the current naming conventions.

This update also included a preliminary restructuring to follow Teck's recommended Table of Contents for OMS Manuals.

In 2017, KCB continued with the restructuring of the OMS Manual such that it will follow Teck's recommended table of contents provided in Teck's Guideline for Tailings and Water Retaining Structures. Additional updates are in progress for the OMS Manual.

5.7 Emergency Preparedness & Response Review

The current version of the OMS Manual (Version 5, March 2017) includes a section for Emergency Planning and Response with an Appendix for Environmental Emergency Response Procedures (no changes were made in 2016 to this section). There is also an Emergency Response Procedures booklet, which is provided to staff and visitors. This booklet outlines response procedures for various

incidents that could occur on site. Several of these are applicable to the tailings facilities. A review of these documents in 2016 indicated that the Emergency Preparedness and Response Plan (EPRP) was inadequate for the tailings facilities. The current version does not follow Teck's internal guideline for an EPRP Plan, especially with respect to potential flood events which could occur during severe storms or following a dam breach.

KCB is currently working with Teck to update the EPRP. The EPRP will be finalized in 2018.

As required by HSRC (MEMPR 2017), the EPRP is tested annually. The most recent test was completed in October 2017.

6 SUMMARY AND RECOMMENDATIONS

6.1 Summary of Construction and Operation Activities

The only construction activities that take place each year are on-going care and maintenance activities such as road grading, cleaning of ditches to remove algae and debris build-up, rodent burrow repair, removal of trees and shrubs from dike slopes, and maintenance of the seepage collection systems around the site. In addition to the annual construction work mentioned above, Teck conducted preliminary clearing/preparation of a location for sludge deposition near the ESP. This site will be used when the sludge dredging of the ARD Pond begins.

Operational activities and reporting conducted during the 2016/2017 DSI period include the following:

- Design work associated with ARD storage and storm water management capacities. This work is ongoing and KCB is working with Teck to review potential options for storing additional ARD water. The work is expected to continue in 2018 and includes reviews of storm water management for the East/West Gypsum Dikes and review of sludge deposition within the ARD Pond.
- Provision of a letter in Q4 2016 presenting the quantifiable performance objectives in place for Sullivan Mine as required by MEMPR (Summary of Exceptions August 15, 2016) under the revised Part 10 of the HSRC.

6.2 Summary of Climate and Water Balance

A review of the water balance data indicated that there were some discrepancies between the measured and calculated pond levels especially for June and July 2017. As discussed in Section 3.2.3, the flow data from Pumps 947/ 948/949/950/952 was under reported between April and August 2017 due to a malfunction of the flow metre. However, while there were issues with the flow metre measurements in 2017, the trend year to year shows a similar discrepancy in the measured and calculated pond levels for months when flow is greatest between the ARD Pond and DWTP. During months with no flow from the pond, the calculated and observed storage match well when the DWTP is shut down. A review of the flow metre measuring the DWTP feed (Pumps 947/948/949/950/952) should be completed such that more accurate data can be obtained.

6.3 Summary of Performance

Klohn Crippen Berger has completed the 2017 DSI of the tailings storage facilities, the ARD Pond dams, and the Sludge Pond and have reviewed the readings from the various instruments installed at the site. Based on this review, we conclude that the tailings storage facilities, Sludge Pond dikes and the ARD Pond dams at Sullivan Mine remain in good condition and there was no evidence of any dam safety related issues or concerns.

In terms of water levels within the ponds and foundation units, the majority of piezometers experienced an increase in the recorded pore pressure in comparison to last year, however, most are

below threshold values and measured pore pressures began to decrease following spring thaw and rainfall. There was higher than average rainfall and increased snowpack during the 2017 reporting period (see Figure III-1), which accounts for the increase in pore pressures. The review did highlight that a number of piezometers were near (within reasonable fluctuation range) or above the threshold levels in 2017. These are discussed below:

- P93-17, P93-18, and P96-08 installed within the Southwest Limb of the Old Iron Pond Dike indicated maximum readings above their threshold levels. The most recent readings for P93-17 and P93-18 have shown a decrease and are currently below the threshold levels. Recent readings for P96-08 indicated erratic readings and the piezometer is to be replaced in 2018.
- P105 within the Siliceous Pond Dike #1 indicated maximum pore pressures 0.16 m above the specified threshold level. Piezometric levels are now below the threshold levels.
- ND-02S within the ARD North Dam indicated a maximum reading 0.13 m above the threshold level. This is not a concern as the most recent reading is now below the threshold.
- PP01-06 installed within the ARD South Dam indicated a maximum pore pressure reading in April that was 0.24 m above the threshold level. This is not a concern as the most recent readings have shown a decrease to values below the threshold.
- SD-02 and SD-03 within the ARD South Dam have indicated maximum readings at the threshold level and 0.1 m above the threshold level, respectively. These maximum readings are not a concern as the most recent readings for each instrument have indicated a decrease to below thresholds.

The threshold levels for the piezometers discussed above will be reviewed in 2018 as, while a number of readings were above the thresholds, they were still below the piezometric levels assumed for design stability analyses. The new thresholds will be assigned to account for the design piezometric levels and periods of higher than average precipitation.

The measured settlements for the Gypsum Dikes were as expected. There was no measurable settlement at the Iron Pond Dike and ARD Pond Dams. The only settlement plates which recorded measurable (>15 mm/year) settlement were those installed upstream of the East and West Gypsum Pond dikes within the tailings. This is as expected as the tailings are continuing to settle and are the only ones required to be surveyed annually.

Surveys of the sludge pond dike crests began in 2016 and continued into 2017 to monitor potential settlement. A comparison of the data (2016 and 2017 and as-built information) indicate little to no settlement of the dikes, which is expected as they were founded on sands and gravels. The survey data also indicated that the most southern portion of the South Dike crest is currently below the design elevation by approximately 0.5 m as a result of the access ramp cutting into the crest. There is a similar issue at the east end of the North Dike, however the design elevation is met but not the crest width. The access ramp at the North Dike was adjusted in Fall 2017, such that the required crest width is now per design. As discussed in Section 5.1.2, the capacity of the sludge pond should be reviewed and the effect of the low spot at the South Dike will be reviewed.

The observed seepage from the dams was as expected and similar to previous years and was clear and free of sediment.

6.4 Summary of Changes to Facility

There have been no changes to the tailings storage facilities during the 2017 DSI reporting period other than regular maintenance.

6.5 Consequence Classification

There are no recommended changes to the consequence classification. There is a potential to lower the classification of the East and West Gypsum Dikes. However, this would require a detailed geotechnical site investigation.

6.6 Table of Deficiencies and Non-conformances

A list of closed, outstanding and new recommendations for the 2018 DSI reporting period is provided in Table 6.1.

Table 6.1 Summary of Closed, Outstanding and New Recommendations

| Structure | No. | Description | Applicable Regulation or OMS Reference | Recommended Action | Priority | Recommended Deadline /Status |
|--------------------|---------|---|---|--|----------|--|
| Closed | | | | | | |
| Iron Pond | 2016-4 | Dike crest elevation adjacent to the ESP | OMS Section 5.0 | Recommend survey of the Iron Dike Crest between Stations 0+00 and 14+00 to determine if crest is at required design elevation. | 3 | CLOSED—Completed May 2017. Dike is at or above El. 1042 m. |
| Outstanding | | | | | | |
| ALL | 2016-1 | OMS Manual requires updates | MEMPR HSRC (2017) & CDA Guidelines: Application to Mining Dams (2014) | Additional information to be added in 2017. EPRP Section to be removed once separate document completed. | 4 | Q4 2018 |
| ALL | 2016-2 | EPR Plan requires updates | MEMPR HSRC (2017) & CDA Guidelines: Application to Mining Dams (2014) | Update EPR Plan such that it follows Teck's Tailings Guidelines and MEM's HSRC (2016a). Currently no mention of potential inundation/flood hazard. | 4 | Q4 2018. |
| Old Iron Pond | 2016-3 | Southwest Limb piezometer P96-11 readings are erratic and unreliable. | OMS Section 4.0 | Recommend replacement of P96-11 (improperly labelled P91-11 in 2016 DSI) with a new piezometer near the toe of the 2007 buttress to monitor piezometric levels at the toe. | 4 | Q3 2018 |
| New | | | | | | |
| Old Iron Pond | 2017-01 | Southwest Limb piezometer P96-08 only records relative piezometric levels as tip elevation is unknown. | OMS Section 4.0 | P96-08 should be replaced as the tip elevation is unknown and the readings only provide relative change in elevation. This instrument will provide additional information regarding piezometric levels near the crest of the dike. | 4 | Q3 2018 |
| Siliceous Ponds | 2017-02 | Siliceous Dike #3 standpipe piezometers P301, 302 and 303 contain significant sediment, which was not removed during flushing in 2014. The bottom depths of these piezometers are now at or just above the phreatic surface assumed for design. | OMS Section 4.0 | These piezometers should be replaced such that the tips are near the base of the tailings to monitor the phreatic surface within the pond. | 4 | Q3 2018 |
| Sludge Pond | 2017-03 | Changes to HSRC design flood requirements indicate a review of the sludge pond hydrology is needed. | MEM HSRC (2017) & CDA Guidelines: Application to Mining Dams (2014) | Review of the current design freeboard and design sludge levels is required for the new design flood event of 1/3 between 1/975 and PMF (HSRC 2016). To facilitate the design update, the sludge pond surface should be surveyed to obtain average sludge deposition rates. This design review should include recommendations for addressing the low crest location at the South Dike. | 3 | Q4 2018 |

The priority ranking for outstanding recommendations is defined as follows:

Priority Description

- 1 A high probability or actual dam safety issue considered immediately dangerous to life, health or the environment, or a significant risk of regulatory enforcement.
- 2 If not corrected could likely result in dam safety issues leading to injury, environmental impact or significant regulatory enforcement; or, a repetitive deficiency that demonstrates a systematic breakdown of procedures.
- 3 Single occurrence of deficiencies or non-conformances that alone would not be expected to result in dam safety issues.
- 4 Best Management Practice – Further improvements are necessary to meet industry best practices or reduce potential risks.

7 CLOSURE

This report is an instrument of service of Klohn Crippen Berger Ltd. The report has been prepared for the exclusive use of Teck Metals Ltd. (Client) for the specific application to the 2017 Dam Safety Inspection. The report's contents may not be relied upon by any other party without the express written permission of Klohn Crippen Berger. In this report, Klohn Crippen Berger has endeavoured to comply with generally-accepted professional practice common to the local area. Klohn Crippen Berger makes no warranty, express or implied.

Yours truly,

KLOHN CRIPPEN BERGER LTD.



Karen Masterson, M.E.Sc., P.Eng.
Senior Geotechnical Engineer



K. Ward Algar, P.Eng. (AB)
Geotechnical Engineer

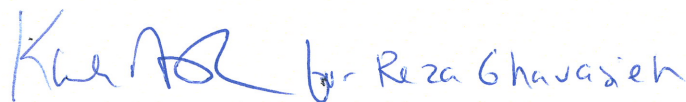

Reza Ghavasieh

Reza Ghavasieh, Ph.D., P.Eng. (AB)
Water Resources Engineer
For Hydrologic Aspects Only

REFERENCES

- Ministry of Energy, Mines and Petroleum Resources, 2016. Guidance Document: Health, Safety and Reclamation Code for Mines in British Columbia. Version 1, July 2016.
- Ministry of Energy, Mines and Petroleum Resources, 2017. Health, Safety and Reclamation Code for Mines in British Columbia Updated February 28, 2017.
- Canadian Dam Association, 2013. Dam Safety Guidelines 2007 (Revised 2013).
- Golder Associates, 2014. 2013 Dam Safety Review. Submitted to Teck Metals Ltd. September 11, 2014. Reference Number 1314270027-002-R-Rev 0-1000.
- Klohn Crippen Consultants, 2000. Sullivan Mine – Storage Pond No. 1 Design Report. Submitted March 20, 2000 to Cominco Ltd. Project No. PM5807.34.
- Klohn Crippen Consultants, 2001. Cominco Sullivan Mine – Tailings Area Post-Closure Water Management Study Final Report. Submitted January 3, 2001 to Cominco Ltd. Project No. PM5807.80.
- Klohn Crippen Consultants, 2002. Geotechnical Design Basis for Tailings Dikes – Overview Summary Report. Submitted January 9, 2002 to TeckCominco Metals Ltd. Project No. PM5807.85.
- Klohn Crippen Consultants, 2002. Storage Pond No. 1 Construction Record Report. Submitted January 31, 2002 to TeckCominco Metals Ltd. Project No. PM5807.83.
- Klohn Crippen Berger, 2007. Sullivan Mine Tailings Area, Emergency Storage Pond (ESP) Spillway Design (ESP). Submitted September 28, 2007 to TeckCominco Metals Ltd. Project No. A05807A04.
- Klohn Crippen Berger, 2009. Sullivan Mine Tailings Facility 2008 Dam Safety Review Report. Submitted April 30, 2009 to Teck Metals, Ltd. Project No. A05807A02.
- Klohn Crippen Berger, 2011. Sullivan Mine Iron Pond Dike Stability. Submitted May 11, 2011 to Teck Metals Ltd. Project No. A05807B10.
- Teck Metals Ltd., 2017. Sullivan – Seepage Collection Manual. Version 005. September 25, 2017.

FIGURES

\\int.khnh.com\ProjData\IC\Y\Alberta\A05807A17 TML Sullivan Mine 2017 DSI\400 Drawings\400 Drawings (2016 Copy)\Figure 1.dwg Layout\Figure 1 October 16, 2017 2:25:27 PM

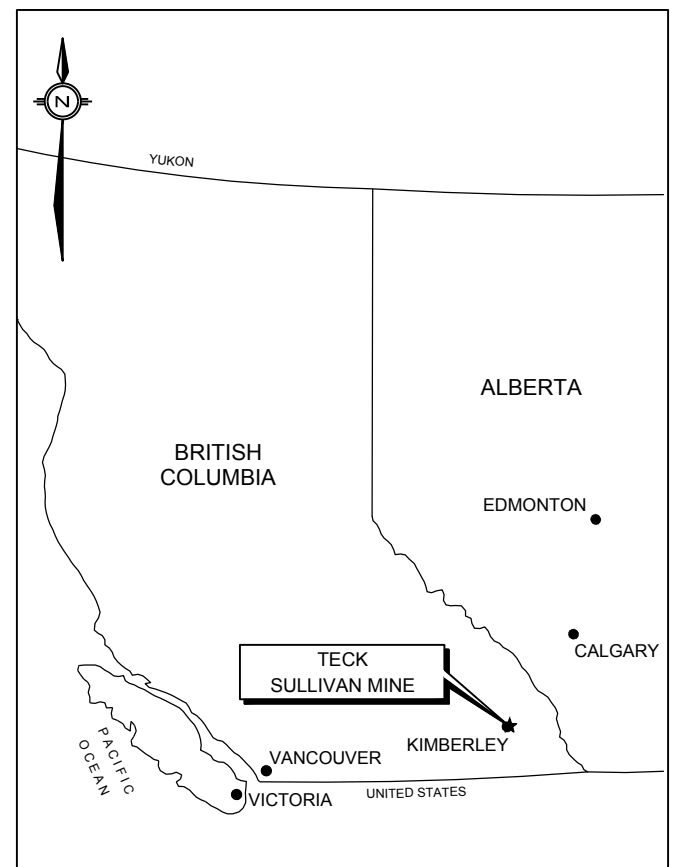
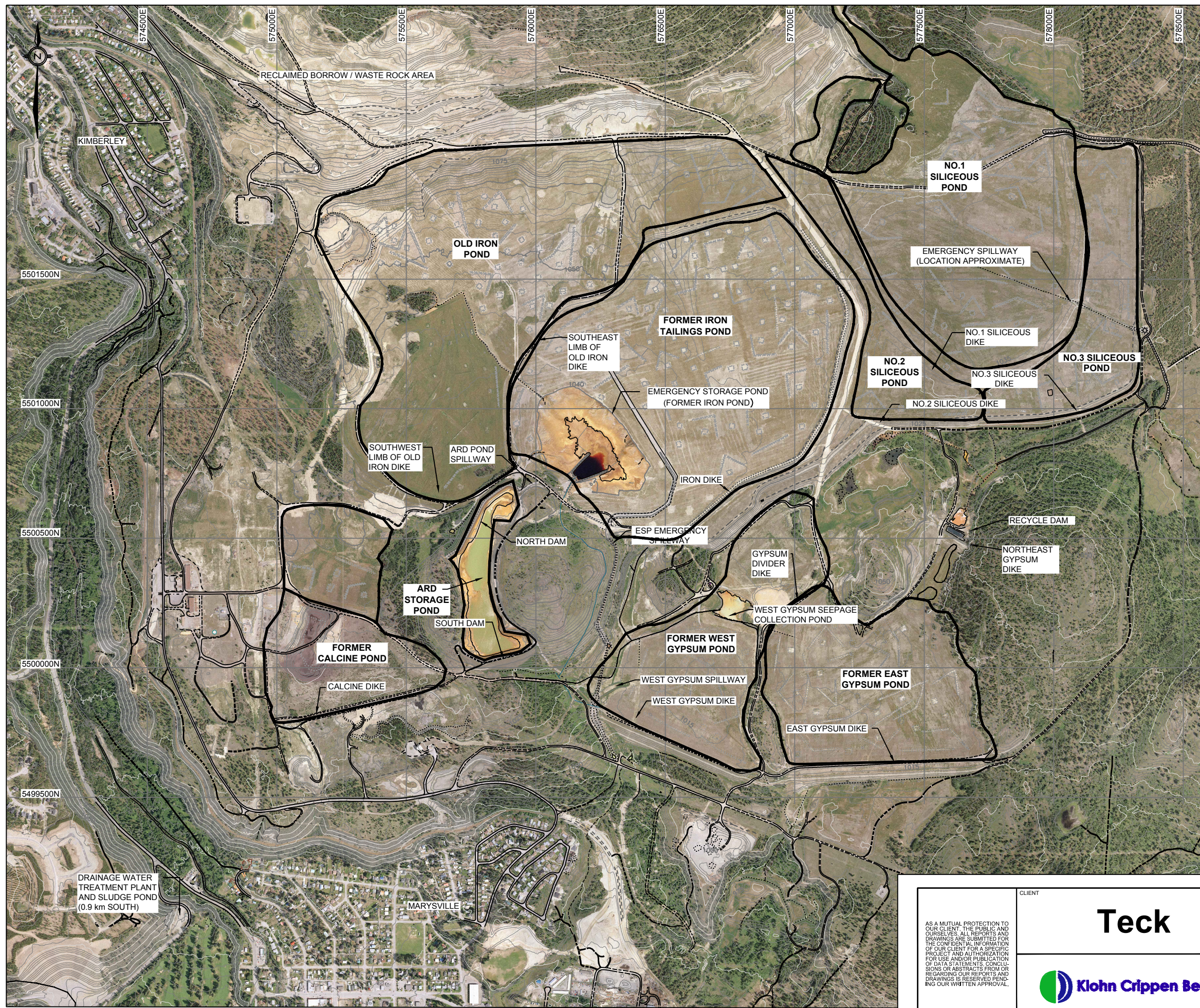

PROJECT LOCATION PLAN
N.T.S

NOTES:

1. GENERAL TOPOGRAPHY FROM LIDAR DATED DECEMBER 2012.
2. ELEVATIONS ARE GEODETIC.
3. MAP COORDINATE SYSTEM = U.T.M. (NAD 83). CONTOUR INTERVAL IS ONE METRE.
4. AERIAL PHOTO PROVIDED BY TECK. DATE: 2008.

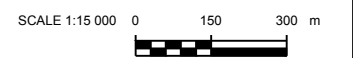

| | | |
|--|--|---|
| <p>AS A MUTUAL PROTECTION TO OUR CLIENT, THE PUBLIC AND OURSELVES, ALL REPORTS AND DRAWINGS ARE SUBMITTED FOR THE CONFIDENTIAL INFORMATION OF OUR CLIENT FOR A SPECIFIC PROJECT AND AUTHORIZATION FOR USE AND/OR PUBLICATION OF DATA STATEMENTS, CONCLUSIONS OR ABSTRACTS FROM OR REGARDING OUR REPORTS AND DRAWINGS IS RESERVED PENDING OUR WRITTEN APPROVAL.</p> | <p>CLIENT</p> <h1 style="margin: 0;">Teck</h1> | <p>PROJECT</p> <p style="text-align: center;">SULLIVAN MINE 2017 DAM SAFETY INSPECTION</p> |
| | | <p>TITLE</p> <p style="text-align: center;">LOCATION AND SITE PLAN</p> |
| | | <p>PROJECT No. A05807A17</p> |
| | | <p>FIG No. FIGURE 1</p> |

KCC-DB

Z:\A\CGY\Alberta\A05807A17.TM\Sullivan_Mine_2017_DSI\400_Drawings\400_Drawings_2016_Copy\Figure_2.dwg Layout=Figure_2 September 14, 2017 2:19:31 PM

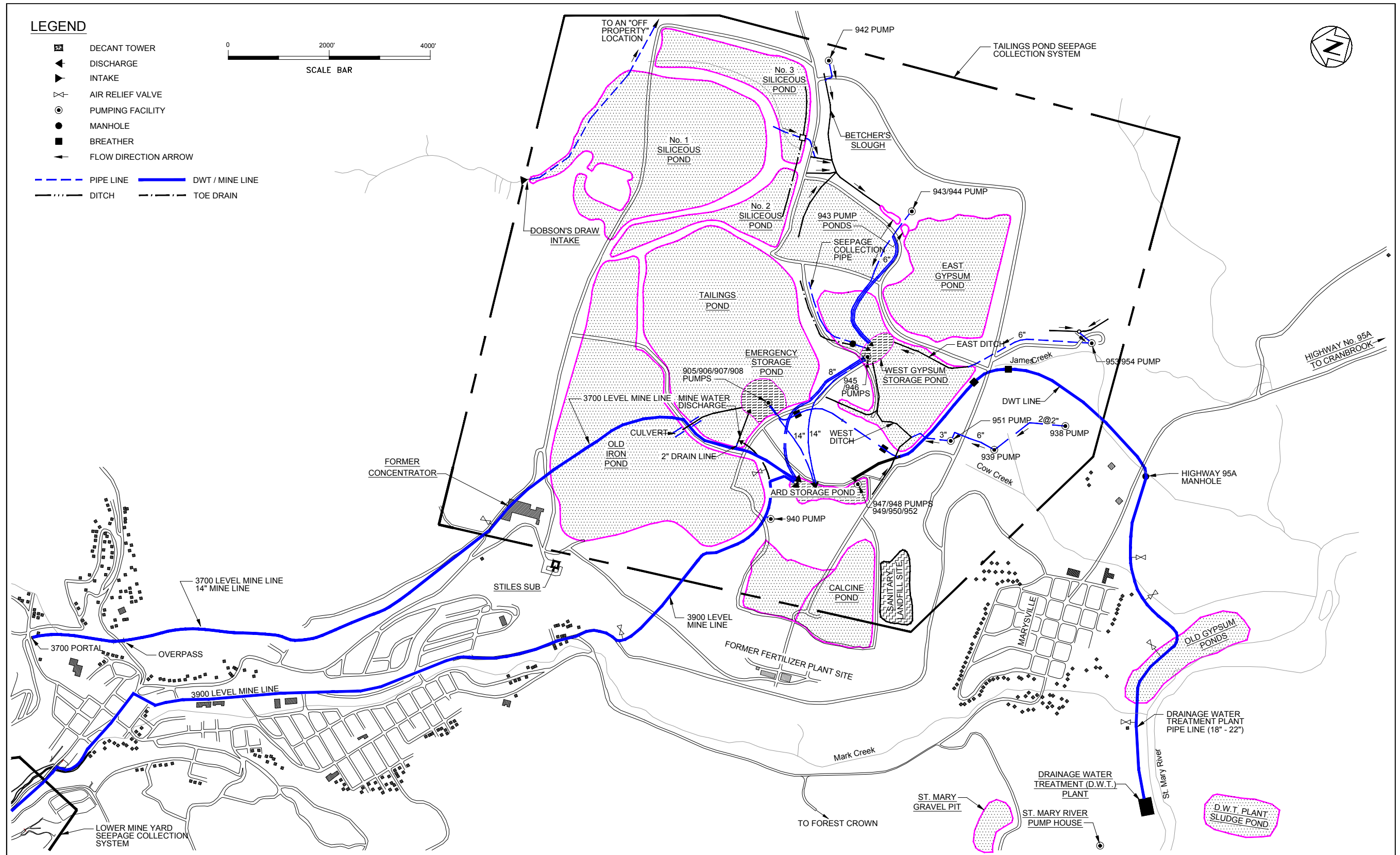

NOTES:

1. FROM TM Tech SERVICES DRAWING K100E3007 DATED FEB. 3, 2009, REV. 1.



| | | | | |
|--|-------------|---|---------|----------|
| <p>AS A MUTUAL PROTECTION TO OUR CLIENT, THE PUBLIC AND OURSELVES, ALL REPORTS AND DRAWINGS ARE SUBMITTED FOR THE CONFIDENTIAL INFORMATION OF OUR CLIENT FOR A SPECIFIC PROJECT AND AUTHORIZATION FOR USE AND/OR PUBLICATION OF DATA STATEMENTS, CONCLUSIONS OR ABSTRACTS FROM OR REGARDING OUR REPORTS AND DRAWINGS IS RESERVED PENDING OUR WRITTEN APPROVAL.</p> | CLIENT | <p>Teck</p> <p>Klohn Crippen Berger</p> | | |
| | PROJECT | <p>SULLIVAN MINE 2017 DAM SAFETY INSPECTION</p> | | |
| | TITLE | <p>TAILINGS SEEPAGE COLLECTION AND DWT PLANT LOCATION</p> | | |
| | PROJECT No. | A05807A17 | FIG No. | FIGURE 2 |

KCC00B

Z:\ACGYA\Alberta\A05807A17 TML Sullivan Mine 2017 DSI\400 Drawings\Figure 3_GenAry.dwg Layout\Figure 3 October 19, 2017 4:51:43 PM



NOTES:

1. GENERAL TOPOGRAPHY FROM LIDAR DATED DECEMBER 2012.
2. ELEVATIONS ARE GEODETIC.
3. MAP COORDINATE SYSTEM = U.T.M. (NAD 83). CONTOUR INTERVAL IS ONE METRE.

LEGEND

- LOCATION AND DIRECTION OF PHOTOGRAPHS TAKEN DURING ANNUAL INSPECTION
- PHOTO NUMBER
- LOCATION WHERE PHOTO WAS TAKEN
- DIRECTION OF VIEW
- PANORAMA



AS A MUTUAL PROTECTION TO OUR CLIENT, THE PUBLIC AND OURSELVES, ALL REPORTS AND DRAWINGS ARE SUBMITTED FOR THE CONFIDENTIAL INFORMATION OF OUR CLIENT FOR A SPECIFIC PROJECT AND AUTHORIZATION FOR USE AND/OR PUBLICATION OF DATA STATEMENTS, CONCLUSIONS OR ABSTRACTS FROM OR REGARDING OUR REPORTS AND DRAWINGS IS RESERVED PENDING OUR WRITTEN APPROVAL.

CLIENT

| | | |
|-------------|---|----------|
| PROJECT | SULLIVAN MINE 2017 DAM SAFETY INSPECTION | |
| TITLE | GENERAL ARRANGEMENT OF TAILINGS FACILITIES | |
| PROJECT No. | A05807A17 | FIG No. |
| | | FIGURE 3 |

KCC-DB

Z:\A\CGY\Alberta\A05807A17 TML Sullivan Mine 2017 DSI\400 Drawings\Figure 4 IronPond.dwg Layout\Figure 4 October 27, 2017 9:47:42 AM

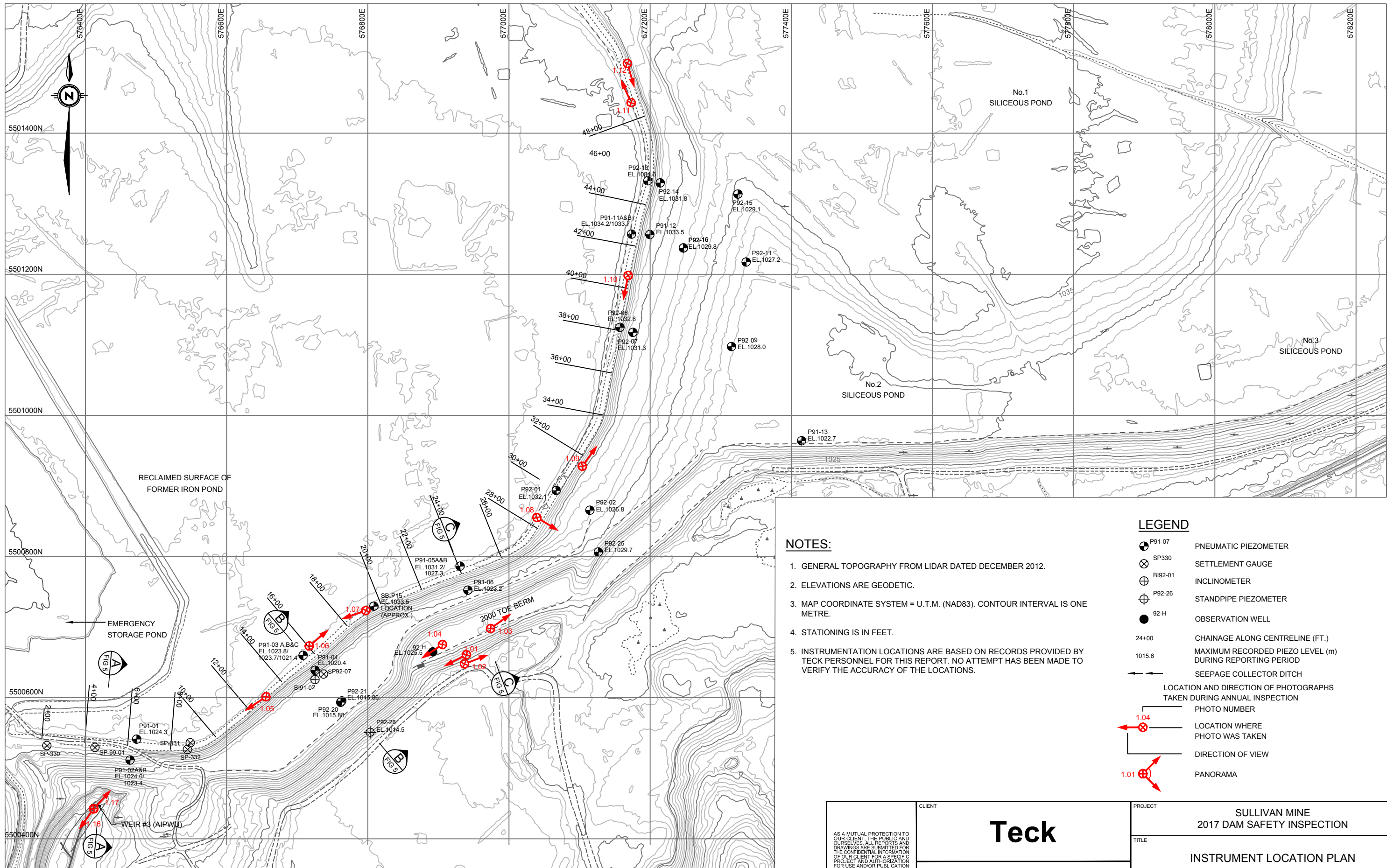

NOTES:

1. GENERAL TOPOGRAPHY FROM LIDAR DATED DECEMBER 2012.
2. ELEVATIONS ARE GEODETIC.
3. MAP COORDINATE SYSTEM = U.T.M. (NAD83). CONTOUR INTERVAL IS ONE METRE.
4. STATIONING IS IN FEET.
5. INSTRUMENTATION LOCATIONS ARE BASED ON RECORDS PROVIDED BY TECK PERSONNEL FOR THIS REPORT. NO ATTEMPT HAS BEEN MADE TO VERIFY THE ACCURACY OF THE LOCATIONS.

LEGEND

- P91-07 PNEUMATIC PIEZOMETER
- SP330 SETTLEMENT GAUGE
- BI92-01 INCLINOMETER
- P92-26 STANDPIPE PIEZOMETER
- 92-H OBSERVATION WELL
- 24+00 CHAINAGE ALONG CENTRELINE (FT.)
- 1015.6 MAXIMUM RECORDED PIEZO LEVEL (m) DURING REPORTING PERIOD
- SEEPAGE COLLECTOR DITCH
- LOCATION AND DIRECTION OF PHOTOGRAPHS TAKEN DURING ANNUAL INSPECTION
- PHOTO NUMBER
- LOCATION WHERE PHOTO WAS TAKEN
- DIRECTION OF VIEW
- PANORAMA

| | | | |
|---|--|--------------------------|--|
| AS A MUTUAL PROTECTION TO OUR CLIENT, THE PUBLIC AND OURSELVES, ALL REPORTS AND DRAWINGS ARE SUBMITTED FOR THE CONFIDENTIAL INFORMATION OF OUR CLIENT FOR A SPECIFIC PROJECT AND AUTHORIZATION FOR USE AND/OR PUBLICATION OF DATA STATEMENTS, CONCLUSIONS OR ABSTRACTS FROM OR REGARDING OUR REPORTS AND DRAWINGS IS RESERVED PENDING OUR WRITTEN APPROVAL. | | CLIENT Teck | PROJECT SULLIVAN MINE 2017 DAM SAFETY INSPECTION |
| | | PROJECT No. A05807A17 | TITLE INSTRUMENT LOCATION PLAN IRON POND DIKE |
| | | PROJECT No. A05807A17 | FIG No. FIGURE 4 |

KCC-08

Z:\A\CSY\Alberta\A05807\A17 TML Sullivan Mine 2017 DS\1400 Drawings\Figure 5 IronPond Sections.dwg Layout\Figure 5 October 27, 2017 9:49:52 AM

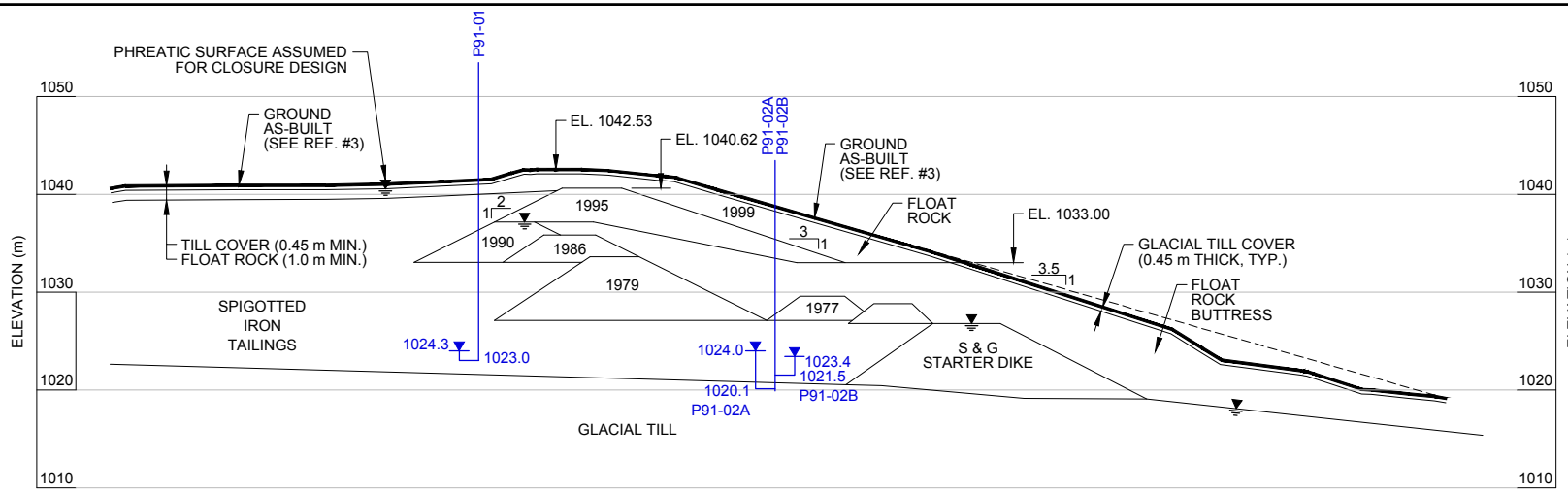

A SECTION
FIG 4 SCALE = 1:750

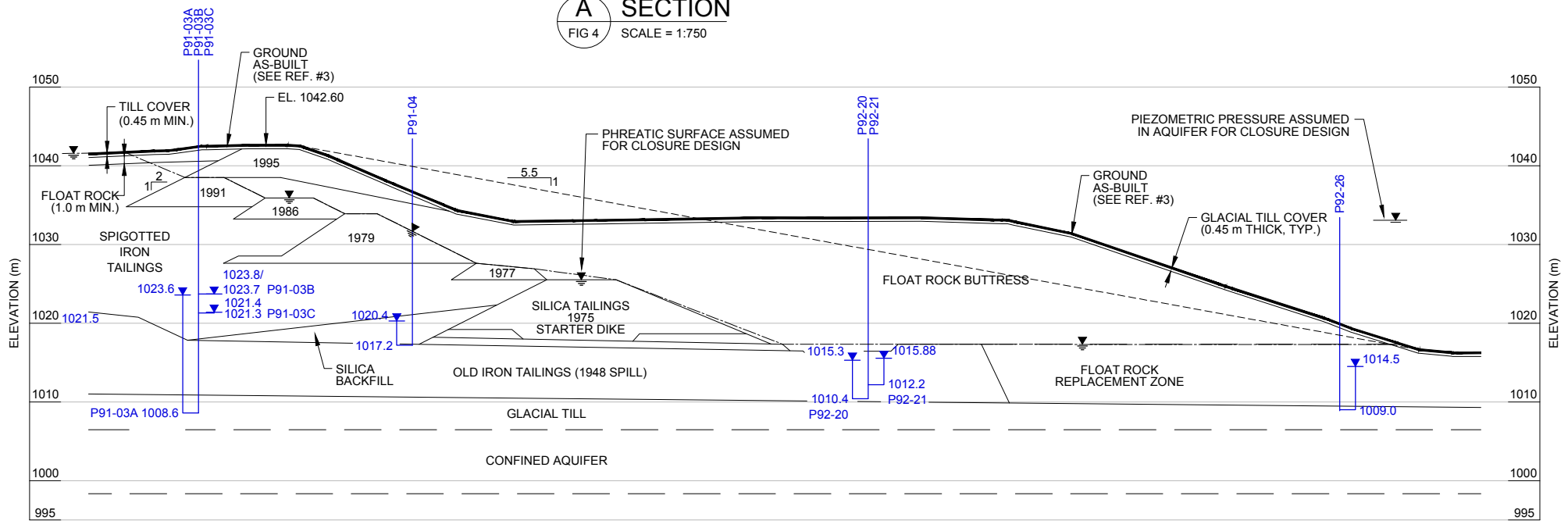

B SECTION
FIG 4 SCALE = 1:750

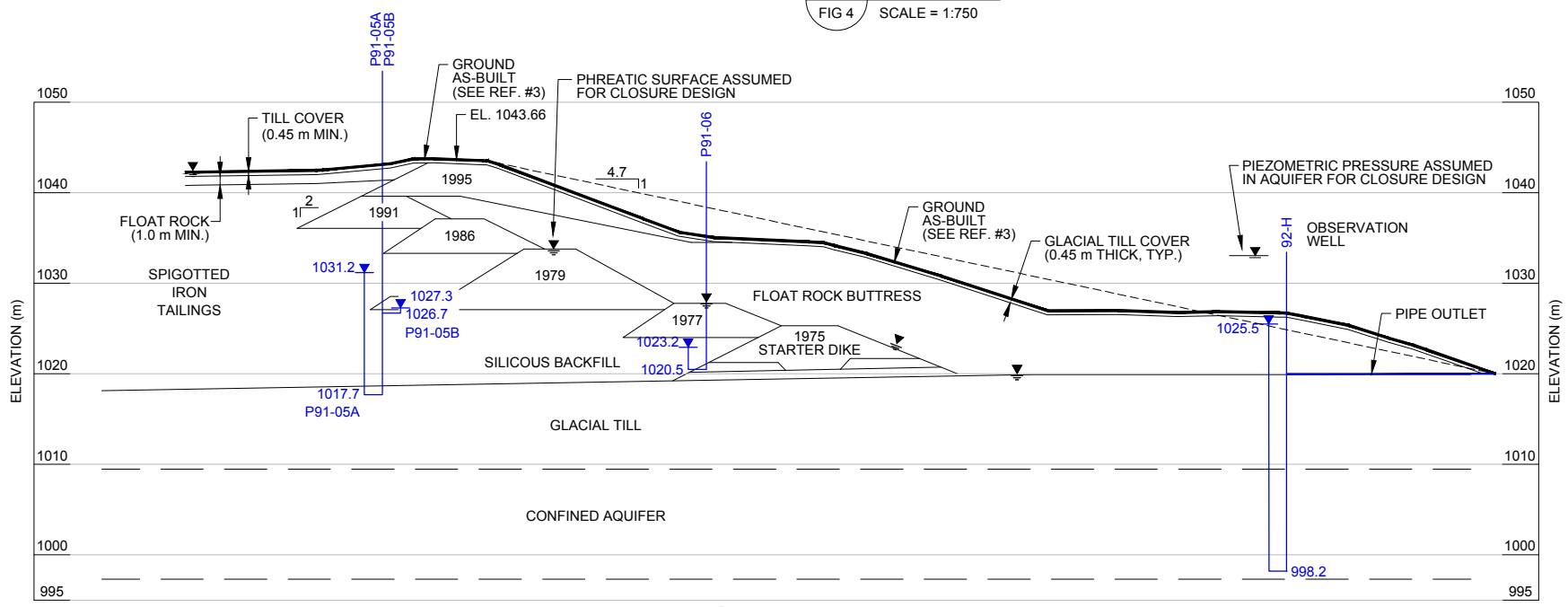

C SECTION
FIG 4 SCALE = 1:750

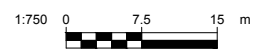

REFERENCES:

1. KLOHN-CRIPPEN REPORT "ACTIVE IRON DIKE - GEOTECHNICAL DESIGN OF 1995 DIKE RAISE", MAY 18, 1995.
2. KLOHN-CRIPPEN SUMMARY REPORT "SULLIVAN MINE - GEOTECHNICAL DESIGN BASIS FOR TAILINGS DIKES", JANUARY 9, 2002.
3. TM TECH SERVICES DRAWINGS K100 A 3233, K100 A 3234 (FEBRUARY 13, 2009).

LEGEND:

- P91-01 PIEZOMETER
- ▼ 1023.8 MAXIMUM RECORDED PIEZO LEVEL (m) DURING REPORTING PERIOD
- 1021.4 PIEZOMETER TIP

| | | |
|---|--|---|
| <p style="font-size: small;">AS A MUTUAL PROTECTION TO OUR CLIENT, THE PUBLIC AND OURSELVES, ALL REPORTS AND DRAWINGS ARE SUBMITTED FOR THE CONFIDENTIAL INFORMATION OF OUR CLIENT FOR A SPECIFIC PROJECT AND AUTHORIZATION FOR USE AND/OR PUBLICATION OF DATA, STATEMENTS, CONCLUSIONS OR ABSTRACTS FROM OR REGARDING OUR REPORTS AND DRAWINGS IS RESERVED PENDING OUR WRITTEN APPROVAL.</p> | <p>CLIENT</p> <h1 style="margin: 0;">Teck</h1> | <p>PROJECT</p> <p>SULLIVAN MINE 2017 DAM SAFETY INSPECTION</p> |
| | | <p>TITLE</p> <p>IRON POND DIKE TYPICAL SECTIONS</p> |
| <p>PROJECT No. A05807A17</p> | | <p>FIG No. FIGURE 5</p> |

KCC-DB

Z:\A\CGY\A\beral\A05807A17 TML Sullivan Mine 2017 DSI\400 Drawings\Figure 6 - OldIronPond.dwg Layout=Figure 6 - October 27, 2017 9:51:40 AM



NOTES:

1. GENERAL TOPOGRAPHY FROM LIDAR DATED DECEMBER 2012.
2. ELEVATIONS ARE GEODETIC.
3. MAP COORDINATE SYSTEM = U.T.M. (NAD83).
4. INSTRUMENTATION LOCATIONS ARE BASED ON RECORDS PROVIDED BY TECK PERSONNEL FOR THIS REPORT. NO ATTEMPT HAS BEEN MADE TO VERIFY THE ACCURACY OF THE LOCATIONS.

LEGEND:

- | | |
|---|--|
| <p>⊕ P205 STANDPIPE PIEZOMETER</p> <p>⊙ P91-07 PNEUMATIC PIEZOMETER</p> <p>EL.1032.1 MAXIMUM RECORDED PIEZO LEVEL (m) DURING REPORTING PERIOD</p> | <p>LOCATION AND DIRECTION OF PHOTOGRAPHS TAKEN DURING ANNUAL INSPECTION</p> <p>PHOTO NUMBER</p> <p>LOCATION WHERE PHOTO WAS TAKEN</p> <p>DIRECTION OF VIEW</p> <p>PANORAMA</p> |
|---|--|

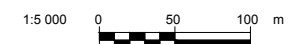

| | | |
|--|--|--|
| <p style="font-size: 8px;">AS A MUTUAL PROTECTION TO OUR CLIENT, THE PUBLIC AND OURSELVES, ALL REPORTS AND DRAWINGS ARE SUBMITTED FOR THE CONFIDENTIAL INFORMATION OF OUR CLIENT FOR A SPECIFIC PROJECT AND AUTHORIZATION FOR USE AND/OR PUBLICATION OF DATA STATEMENTS, CONCLUSIONS OR ABSTRACTS FROM OR REGARDING OUR REPORTS AND DRAWINGS IS RESERVED PENDING OUR WRITTEN APPROVAL.</p> | <p>CLIENT</p> <h1 style="margin: 0;">Teck</h1> | <p>PROJECT</p> <p>SULLIVAN MINE 2017 DAM SAFETY INSPECTION</p> |
| | <p>Klohn Crippen Berger</p> | <p>TITLE</p> <p>INSTRUMENT LOCATION PLAN OLD IRON POND DIKE</p> |
| PROJECT No. A05807A17 | | FIG No. FIGURE 6 |

KCC-DB

Z:\A\CSY\Alberta\A05807\A17 TML - Sullivan Mine 2017 DSI\400 Drawings\Figure 7 - OldIronPond Section.dwg Layout\Figure 7 October 19, 2017 4:33:28 PM

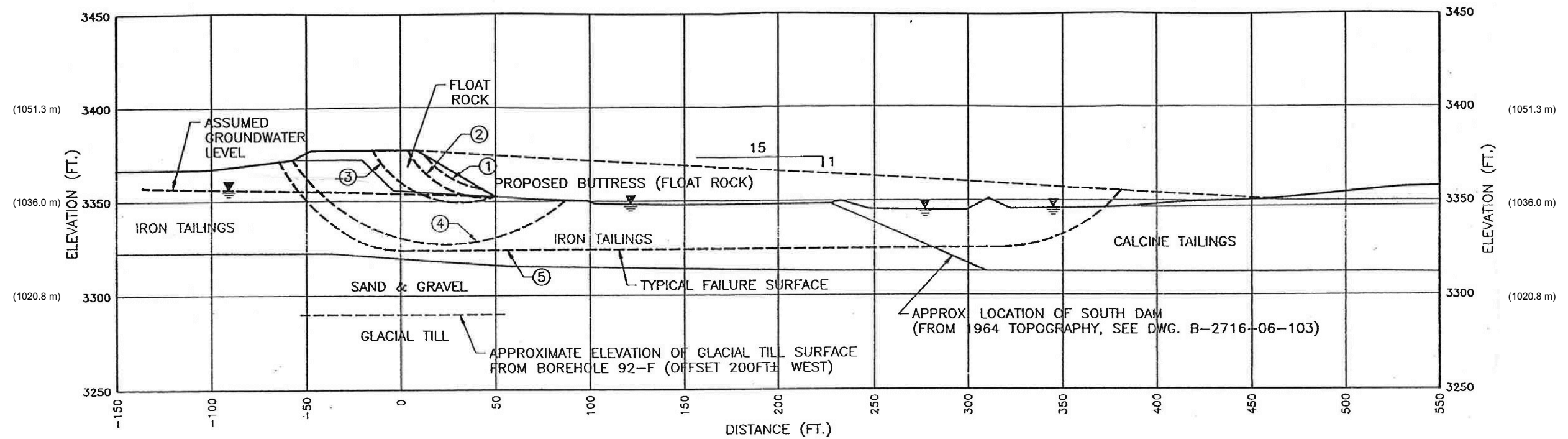

D SECTION
FIG 6 SCALE = N.T.S.

| | | |
|---|--------------------------|---|
| <small>AS A MUTUAL PROTECTION TO OUR CLIENT, THE PUBLIC AND OURSELVES, ALL REPORTS AND DRAWINGS ARE SUBMITTED FOR THE CONFIDENTIAL INFORMATION OF OUR CLIENT FOR A SPECIFIC PROJECT AND AUTHORIZATION FOR USE AND/OR PUBLICATION OF DATA, STATEMENTS, CONCLUSIONS OR ABSTRACTS FROM OR REGARDING OUR REPORTS AND DRAWINGS IS RESERVED PENDING OUR WRITTEN APPROVAL.</small> | Teck | PROJECT SULLIVAN MINE 2017 DAM SAFETY INSPECTION |
| | | TITLE OLD IRON POND DIKE / SOUTHWEST LIMB TYPICAL SECTION |
| | PROJECT No. A05807A17 | FIG No. FIGURE 7 |



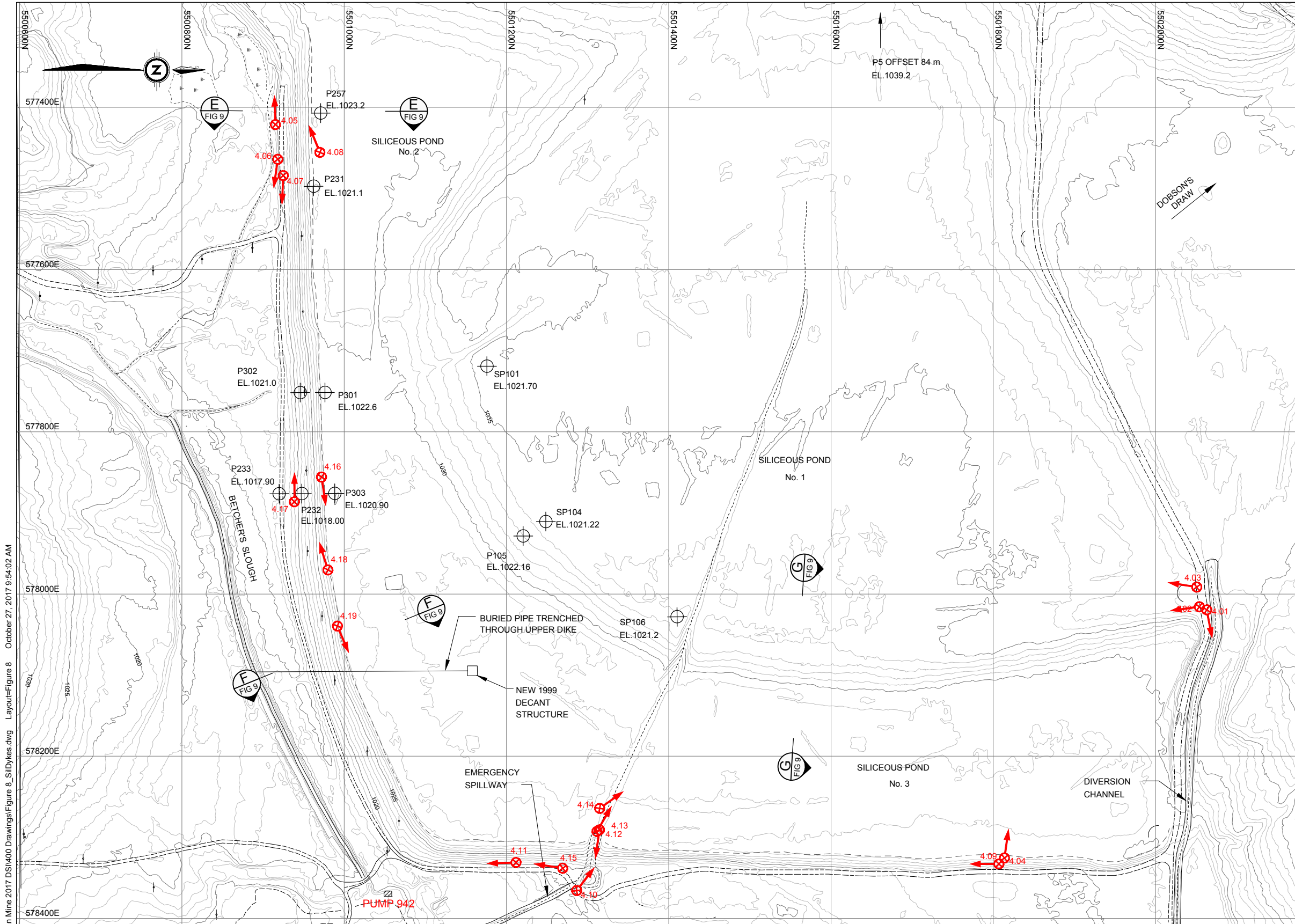





KCC-DB



NOTES:

1. GENERAL TOPOGRAPHY FROM LIDAR DATED DECEMBER 2012.
2. ELEVATIONS ARE GEODETIC.
3. MAP COORDINATE SYSTEM = U.T.M. (NAD83).
4. INSTRUMENTATION LOCATIONS ARE BASED ON RECORDS PROVIDED BY TECK PERSONNEL FOR THIS REPORT. NO ATTEMPT HAS BEEN MADE TO VERIFY THE ACCURACY OF THE LOCATIONS.
5. SPILLWAY LOCATIONS ARE APPROXIMATE.

LEGEND:

-  PNEUMATIC PIEZOMETER
-  STANDPIPE PIEZOMETER
-  STANDPIPE PIEZOMETER AND SETTLEMENT PLATE
- EL.1032.1
MAXIMUM RECORDED PIEZO LEVEL (m) DURING REPORTING PERIOD
-  LOCATION AND DIRECTION OF PHOTOS TAKEN DURING ANNUAL INSPECTION
-  PHOTO NUMBER
-  LOCATION WHERE PHOTO WAS TAKEN
-  DIRECTION OF VIEW
-  PANORAMA

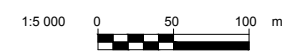

Z:\ACGY\Alberta\A05807A17 TML Sullivan Mine 2017 DSI\400 Drawings\Figure 8_Silldikes.dwg Layout=Figure 8 October 27, 2017 9:54:02 AM

| | | | |
|--|---|--|-------------------------|
| AS A MUTUAL PROTECTION TO OUR CLIENT, THE PUBLIC AND OURSELVES, ALL REPORTS AND DRAWINGS ARE SUBMITTED FOR THE CONFIDENTIAL INFORMATION OF OUR CLIENT FOR A SPECIFIC PROJECT AND AUTHORIZATION FOR USE AND/OR PUBLICATION OF DATA, STATEMENTS, CONCLUSIONS OR ABSTRACTS FROM OR REGARDING OUR REPORTS AND DRAWINGS IS RESERVED PENDING OUR WRITTEN APPROVAL. | Teck | PROJECT SULLIVAN MINE 2017 DAM SAFETY INSPECTION | |
| |  | TITLE INSTRUMENT LOCATION PLAN NO. 1, 2 & 3 SILICEOUS POND DIKES | |
| | PROJECT No. A05807A17 | | FIG No. FIGURE 8 |

KCC09B

Z:\ACG\Y\Alberta\A05807A17 TML Sullivan Mine 2017 DSI\400 Drawings\Figure 9_SilDikes Sections.dwg Layout\Figure 9 October 27, 2017 9:55:16 AM

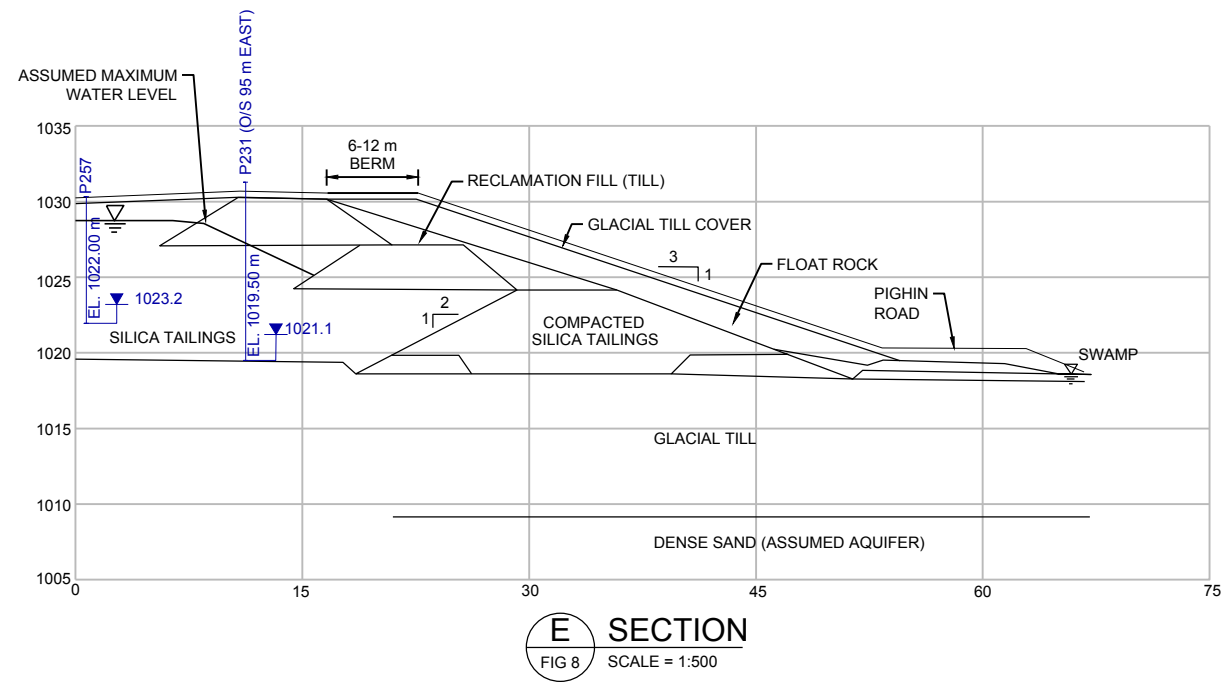

E SECTION
FIG 8 SCALE = 1:500

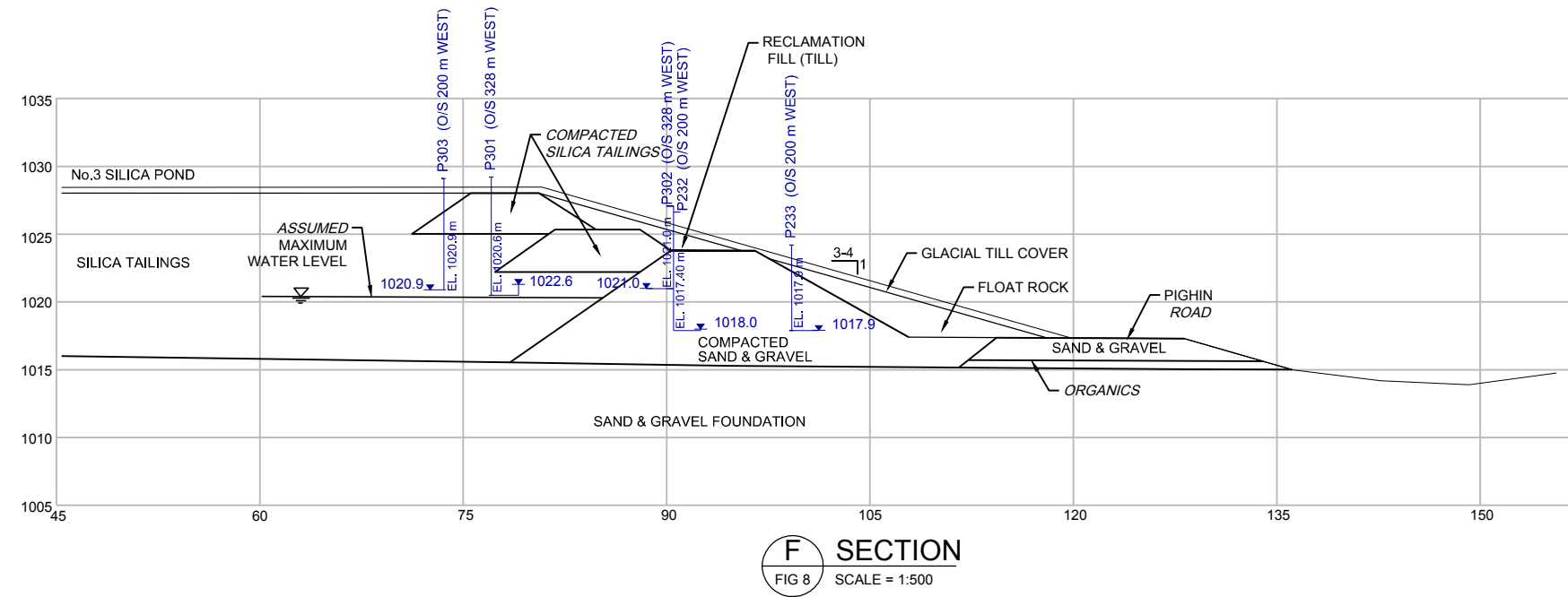

F SECTION
FIG 8 SCALE = 1:500

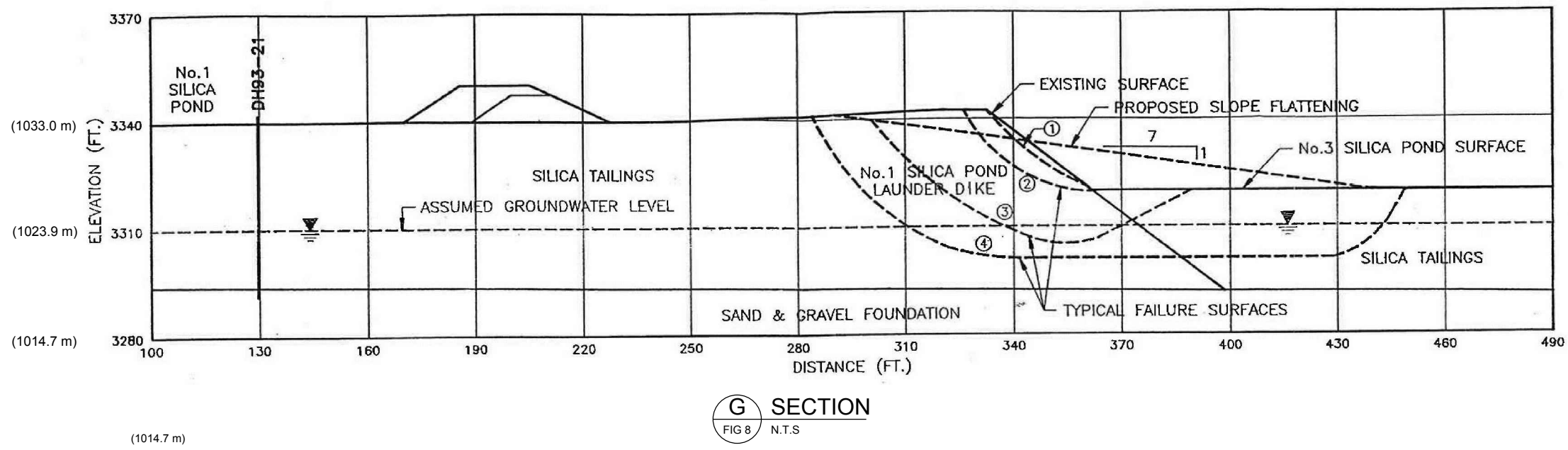

G SECTION
FIG 8 N.T.S

NOTES:

- UNITS ARE IN METERS, UNLESS INDICATED OTHERWISE ON FIGURE.
- SECTION A & B WERE GENERATED FROM DRAWINGS B-2716-06-211 & B2716-06-210, RESPECTIVELY, IN REPORT TITLED "SULLIVAN MINE GEOTECHNICAL DESIGN BASIS FOR TAILINGS DIKES - OVERVIEW SUMMARY REPORT" DATED JANUARY 2002 BY KLOHN CRIPPEN.
- MAXIMUM ANNUAL PIEZO ELEVATION.

LEGEND:

- PNEUMATIC PIEZOMETER
- P205** STANDPIPE PIEZOMETER
- SP206** STANDPIPE PIEZOMETER AND SETTLEMENT PLATE
- P91-01** PIEZOMETER
- 1023.8** MAXIMUM RECORDED PIEZO LEVEL (m) DURING REPORTING PERIOD
- 1021.4** PIEZOMETER TIP

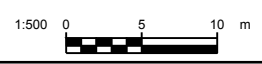

| | | | | |
|---|-------------------------------------|--|--------------------------------|---|
| <p>AS A MUTUAL PROTECTION TO OUR CLIENT, THE PUBLIC AND OURSELVES, ALL REPORTS AND DRAWINGS ARE SUBMITTED FOR THE CONFIDENTIAL INFORMATION OF OUR CLIENT FOR A SPECIFIC PROJECT AND AUTHORIZATION FOR USE AND/OR PUBLICATION OF DATA, STATEMENTS, CONCLUSIONS OR ABSTRACTS FROM OR REGARDING OUR REPORTS AND DRAWINGS IS RESERVED PENDING OUR WRITTEN APPROVAL.</p> | <p>CLIENT</p> | <p>PROJECT</p> <p>SULLIVAN MINE 2017 DAM SAFETY INSPECTION</p> | | |
| | | | | <p>TITLE</p> <p>SILICEOUS POND DIKES TYPICAL SECTIONS</p> |
| | <p>PROJECT No.</p> <p>A05807A17</p> | | <p>FIG No.</p> <p>FIGURE 9</p> | |

KCC-DB

Z:\AC\GY\A\berib\A05807A17 TML Sullivan Mine 2017 DSI\400 Drawings\Figure 10_WeirGyp.dwg Layout\Figure 10 October 27, 2017 9:56:39 AM

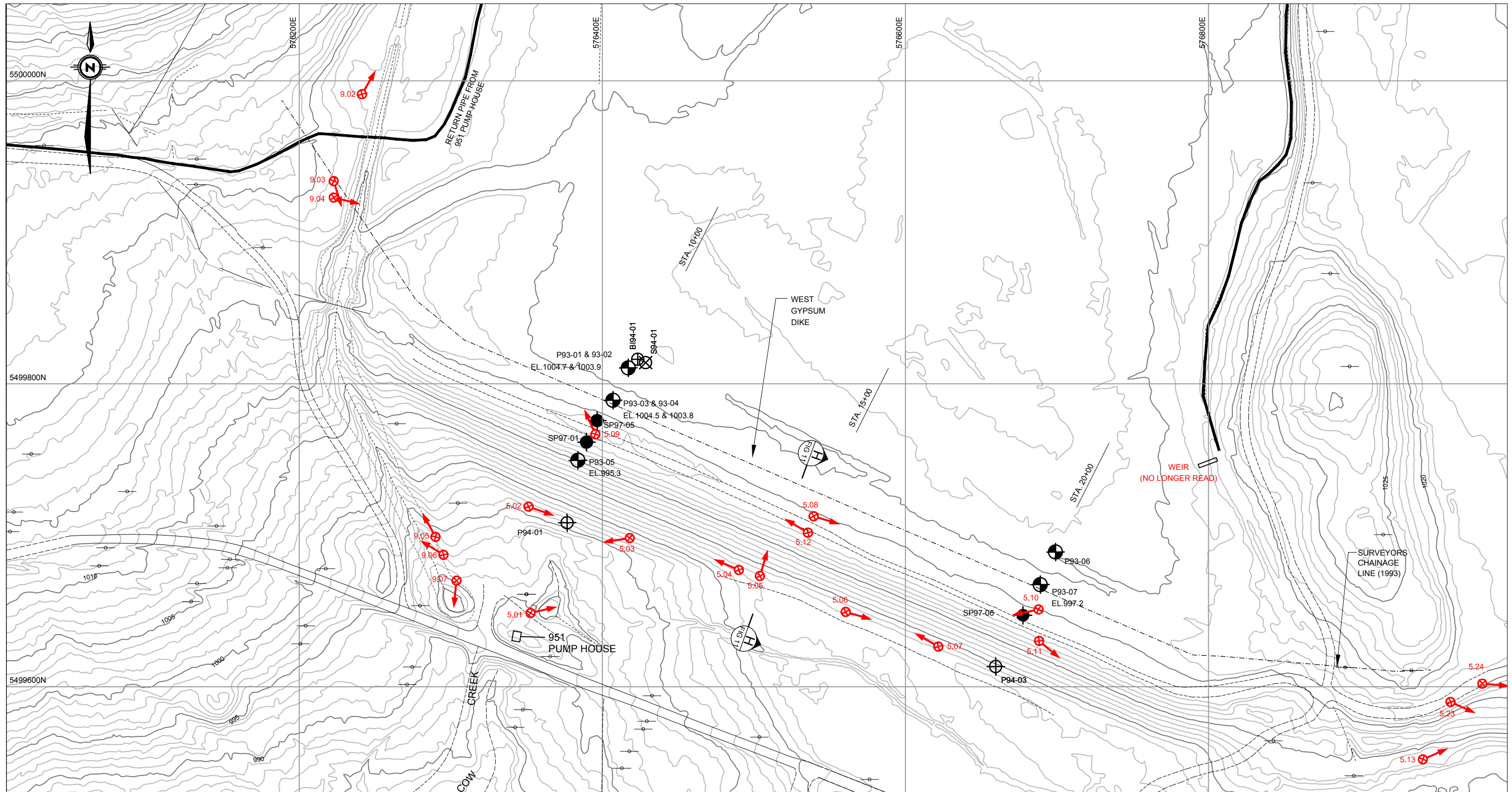

NOTES:

1. GENERAL TOPOGRAPHY FROM LIDAR DATED DECEMBER 2012.
2. ELEVATIONS ARE GEODETIC.
3. MAP COORDINATE SYSTEM = U.T.M. (NAD83). CONTOUR INTERVAL IS ONE METRE.
4. STATIONING IS IN FEET.
5. INSTRUMENTATION LOCATIONS ARE BASED ON RECORDS PROVIDED BY TECK NO ATTEMPT HAS BEEN MADE TO VERIFY THE ACCURACY OF THE LOCATIONS.

LEGEND:

- P93-15 1993 STANDPIPE PIEZOMETER
- P94-01 STANDPIPE PIEZOMETER
- SP97-01 SETTLEMENT PLATE
- BI94-02 INCLINOMETER
- S94-02 SONDEX SETTLEMENT GAUGE
- EL. 1032.1 MAXIMUM RECORDED PIEZO LEVEL (m) DURING REPORTING PERIOD

LOCATION AND DIRECTION OF PHOTOGRAPHS TAKEN DURING ANNUAL INSPECTION

- PHOTO NUMBER
- LOCATION WHERE PHOTO WAS TAKEN
- DIRECTION OF VIEW
- PANORAMA



AS A MUTUAL PROTECTION TO OUR CLIENT, THE PUBLIC AND OURSELVES, ALL REPORTS AND DRAWINGS ARE SUBMITTED FOR THE CONFIDENTIAL INFORMATION OF OUR CLIENT FOR A SPECIFIC PROJECT AND AUTHORIZATION FOR USE AND/OR PUBLICATION OF DATA STATEMENTS, CONCLUSIONS OR ABSTRACTS FROM OR REGARDING OUR REPORTS AND DRAWINGS IS RESERVED PENDING OUR WRITTEN APPROVAL.

CLIENT

Teck

Klohn Crippen Berger

| | | |
|-------------|--|-----------|
| PROJECT | SULLIVAN MINE 2017 DAM SAFETY INSPECTION | |
| TITLE | INSTRUMENT LOCATION PLAN WEST GYPSUM DIKE | |
| PROJECT No. | A05807A17 | FIG No. |
| | | FIGURE 10 |

KCC-DB

Z:\A\CSY\Alberta\A05807A17 TML Sullivan Mine 2017 DSI\400 Drawings\Figure 11 - WestGyp Section.dwg Layout=Figure 11 October 27, 2017 9:58:13 AM

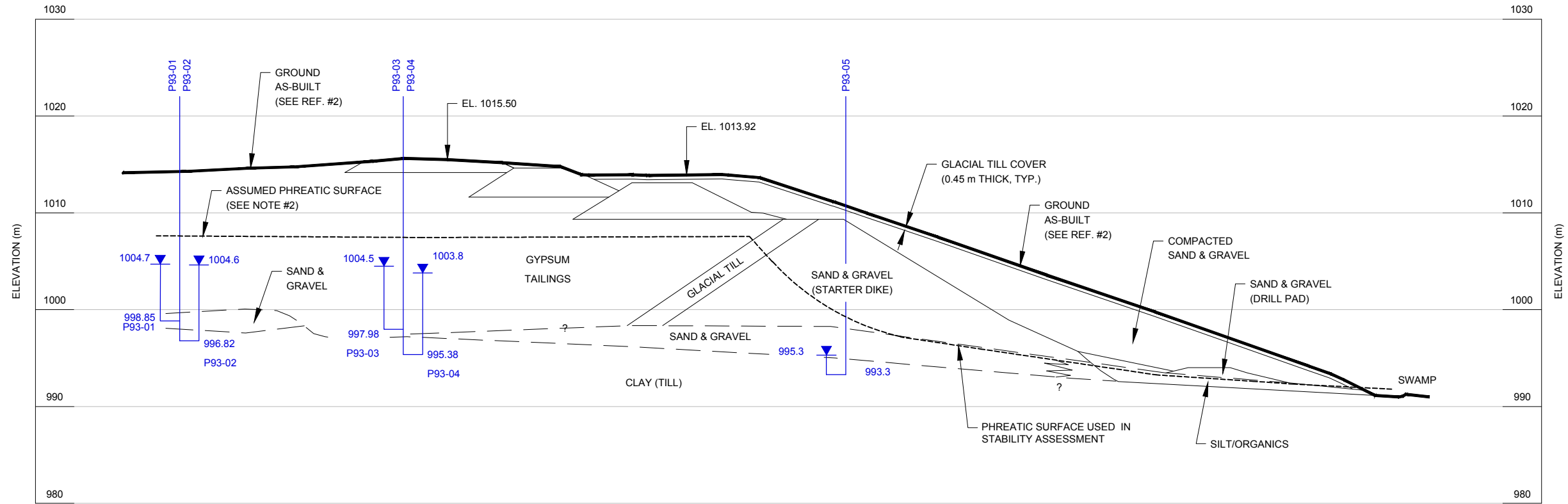

H SECTION
 FIG 10 SCALE = 1:500

REFERENCES:

1. KLOHN-CRIPPEN SUMMARY REPORT "SULLIVAN MINE - GEOTECHNICAL DESIGN BASIS FOR TAILINGS DIKES", JANUARY 9, 2002.
2. TM TECH SERVICES DRAWINGS K100 A 3230, K100 A 3231, JANUARY 29, 2007.
3. KLOHN CRIPPEN BERGER "SULLIVAN MINE - STABILITY REVIEW OF GYPSUM DIKES", NOVEMBER 26, 1993.

NOTES:

1. UNITS ARE IN METERS UNLESS OTHERWISE STATED.
2. PHREATIC SURFACE IS THAT ASSUMED IN KLOHN CRIPPEN BERGER REPORT ENTITLED "SULLIVAN MINE - STABILITY REVIEW OF GYPSUM DIKES" NOVEMBER, 1993.

LEGEND:

- P93-01 PIEZOMETER
- 1006.30 MAXIMUM RECORDED PIEZO LEVEL (m) DURING REPORTING PERIOD
- 1000.2 PIEZOMETER TIP

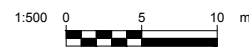

| | | |
|--|------------|--|
| AS A MUTUAL PROTECTION TO OUR CLIENT, THE PUBLIC AND OURSELVES, ALL REPORTS AND DRAWINGS ARE SUBMITTED FOR THE CONFIDENTIAL INFORMATION OF OUR CLIENT FOR A SPECIFIC PROJECT AND AUTHORIZATION FOR USE AND/OR PUBLICATION OF DATA, STATEMENTS, CONCLUSIONS OR ABSTRACTS FROM OR REGARDING OUR REPORTS AND DRAWINGS IS RESERVED PENDING OUR WRITTEN APPROVAL. | CLIENT | PROJECT SULLIVAN MINE 2017 DAM SAFETY INSPECTION |
| | | TITLE WEST GYPSUM POND DIKE TYPICAL SECTION |
| PROJECT No. A05807A17 | | FIG No. FIGURE 11 |

KCC-DB

Z:\A\CGY\Alberta\A05807A17 TML Sullivan Mine 2017 DSI\400 Drawings\Figure 12_EastGyp.dwg Layout=Figure 12 October 27, 2017 9:59:37 AM

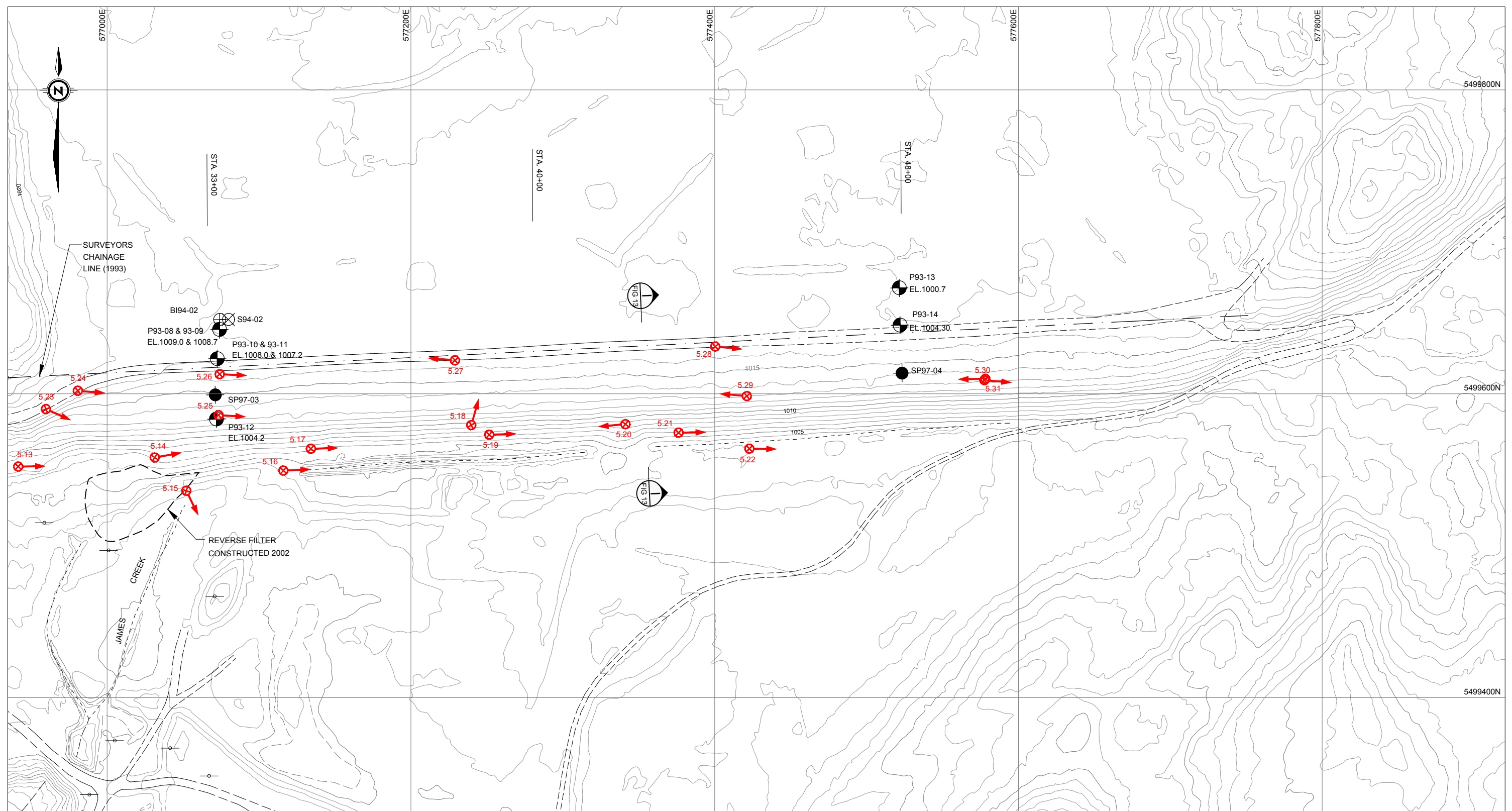

NOTES:

1. GENERAL TOPOGRAPHY FROM LIDAR DATED DECEMBER 2012.
2. ELEVATIONS ARE GEODETIC.
3. MAP COORDINATE SYSTEM = U.T.M. (NAD83), CONTOUR INTERVAL IS ONE METRE.
4. STATIONING IS IN FEET.
5. INSTRUMENTATION LOCATIONS ARE BASED ON RECORDS PROVIDED BY TECK NO ATTEMPT HAS BEEN MADE TO VERIFY THE ACCURACY OF THE LOCATIONS.

LEGEND:

- P93-15 1993 STANDPIPE PIEZOMETER
- P94-01 STANDPIPE PIEZOMETER
- SP97-01 SETTLEMENT PLATE
- BI94-02 INCLINOMETER
- S94-02 SONTEX SETTLEMENT GAUGE
- EL.1032.1 MAXIMUM RECORDED PIEZO LEVEL (m) DURING REPORTING PERIOD

LOCATION AND DIRECTION OF PHOTOGRAPHS TAKEN DURING ANNUAL INSPECTION

- PHOTO NUMBER
- LOCATION WHERE PHOTO WAS TAKEN
- DIRECTION OF VIEW
- PANORAMA

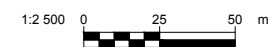

AS A MUTUAL PROTECTION TO OUR CLIENT, THE PUBLIC AND OURSELVES, ALL REPORTS AND DRAWINGS ARE SUBMITTED FOR THE CONFIDENTIAL INFORMATION OF OUR CLIENT FOR A SPECIFIC PROJECT AND AUTHORIZATION FOR USE AND/OR PUBLICATION OF DATA STATEMENTS, CONCLUSIONS OR ABSTRACTS FROM OR REGARDING OUR REPORTS AND DRAWINGS IS RESERVED PENDING OUR WRITTEN APPROVAL.

CLIENT

Teck

Klohn Crippen Berger

| | | | |
|-------------|-----------|--|-----------|
| PROJECT | | SULLIVAN MINE 2017 DAM SAFETY INSPECTION | |
| TITLE | | INSTRUMENT LOCATION PLAN EAST GYPSUM DIKE | |
| PROJECT No. | A05807A17 | FIG No. | FIGURE 12 |

KCC018

Z:\A\CGY\Alberta\A05807A17 TML Sullivan Mine 2017 DS1400 Drawings\Figure 13 - EastGyp Section.dwg October 27, 2017 10:00:49 AM

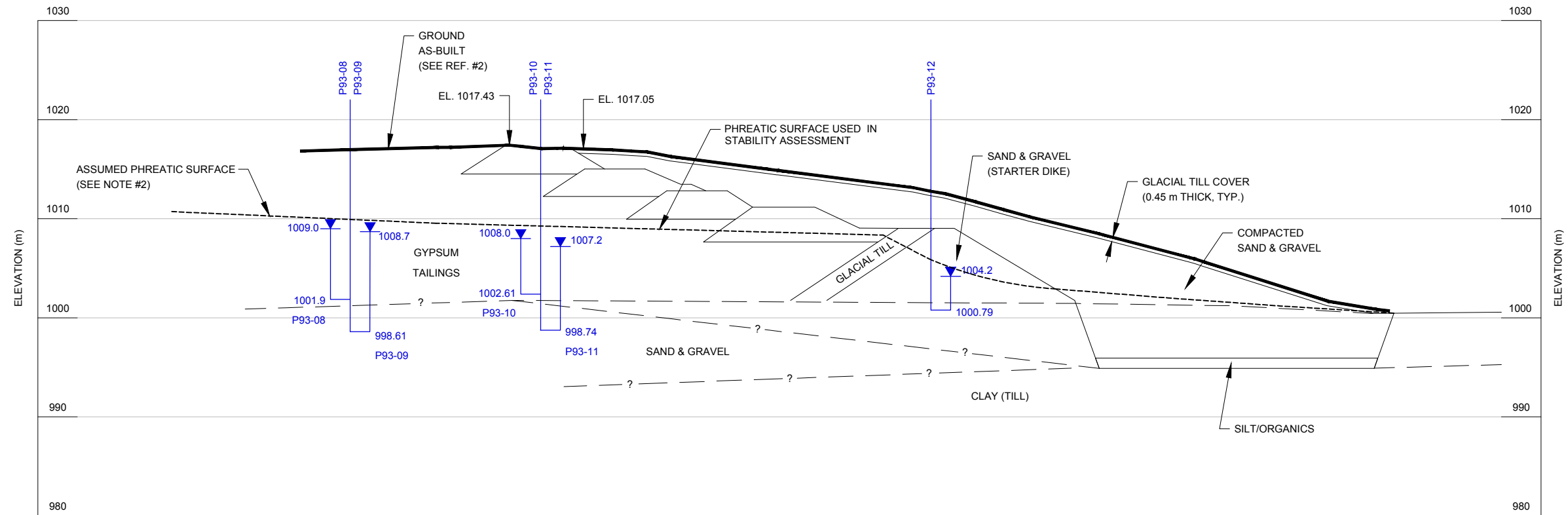

REFERENCES:

1. KLOHN-CRIPPEN SUMMARY REPORT "SULLIVAN MINE - GEOTECHNICAL DESIGN BASIS FOR TAILINGS DIKES", JANUARY 9, 2002.
2. TM TECH SERVICES DRAWINGS K100 A 3230, K100 A 3231, JANUARY 29, 2007.
3. KLOHN CRIPPEN BERGER "SULLIVAN MINE - STABILITY REVIEW OF GYPSUM DIKES", NOVEMBER 26, 1993.

NOTES:

1. UNITS ARE IN METERS UNLESS OTHERWISE STATED.
2. PHREATIC SURFACE IS THAT ASSUMED IN KLOHN CRIPPEN BERGER REPORT ENTITLED "SULLIVAN MINE - STABILITY REVIEW OF GYPSUM DIKES" NOVEMBER, 1993.

LEGEND:

- P93-01 PIEZOMETER
- ▼ 1006.30 MAXIMUM RECORDED PIEZO LEVEL (m) DURING REPORTING PERIOD
- | 1000.2 PIEZOMETER TIP

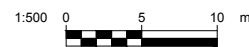

| | | | |
|--|--|--|--|
| AS A MUTUAL PROTECTION TO OUR CLIENT, THE PUBLIC AND OURSELVES, ALL REPORTS AND DRAWINGS ARE SUBMITTED FOR THE CONFIDENTIAL INFORMATION OF OUR CLIENT FOR A SPECIFIC PROJECT AND AUTHORIZATION FOR USE AND/OR PUBLICATION OF DATA, STATEMENTS, CONCLUSIONS OR ABSTRACTS FROM OR REGARDING OUR REPORTS AND DRAWINGS IS RESERVED PENDING OUR WRITTEN APPROVAL. | | CLIENT Teck | PROJECT SULLIVAN MINE 2017 DAM SAFETY INSPECTION |
| | | TITLE EAST GYPSUM POND TYPICAL SECTION | PROJECT No. A05807A17 |
| | | FIG No. FIGURE 13 | FIG No. FIGURE 13 |

KCC-DB

\\int.klohn.com\ProjData\AC\GY\Alberta\A05807A17 TML Sullivan Mine 2017\DSI\400 Drawings\400 Drawings (2016 Copy)\Figure 14_NEGyp.dwg Layout\Figure 14 October 16, 2017 4:51:52 PM

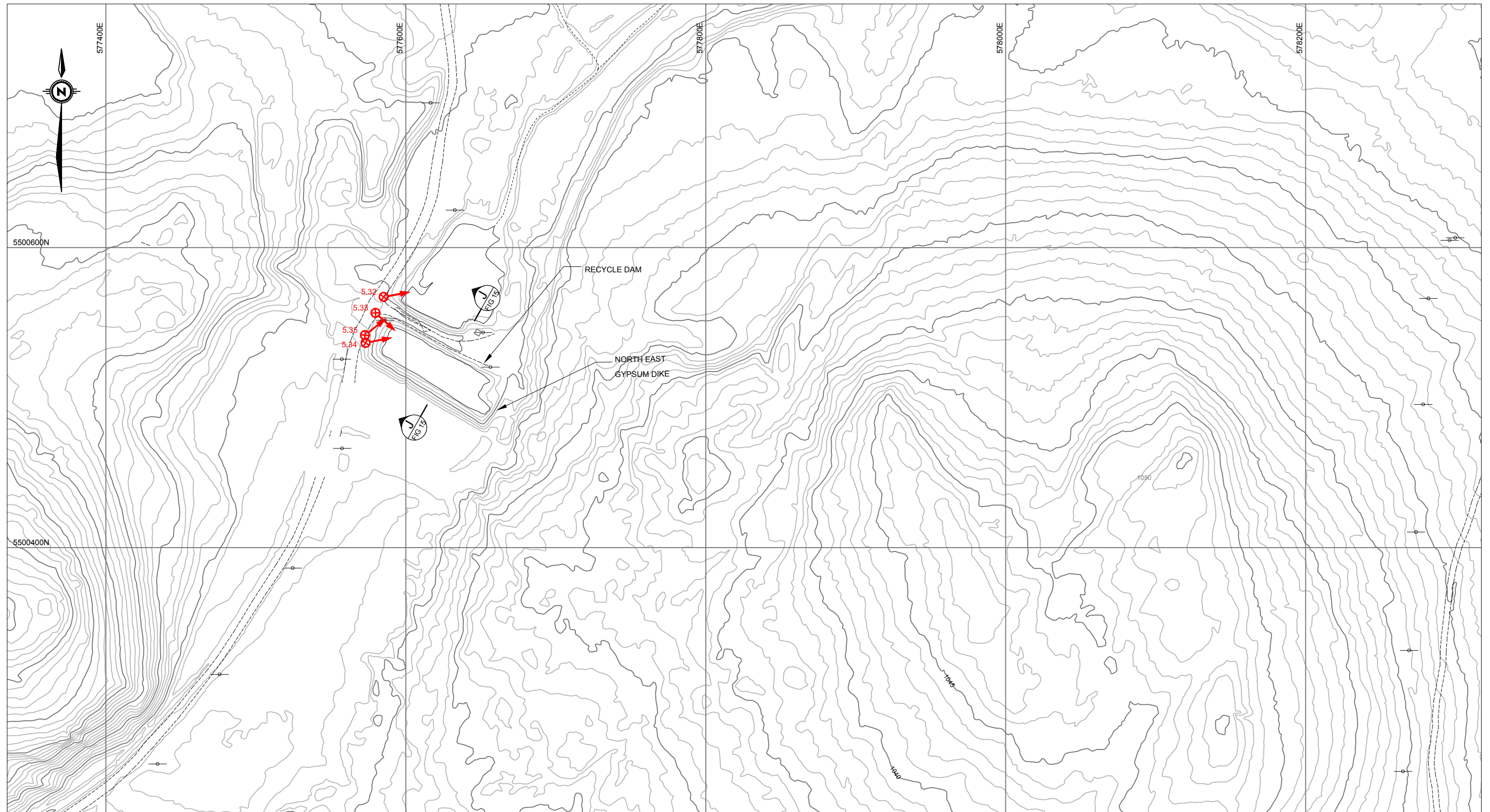

NOTES:

1. GENERAL TOPOGRAPHY FROM LIDAR DATED DECEMBER 2012.
2. ELEVATIONS ARE GEODETIC.
3. MAP COORDINATE SYSTEM = U.T.M. (NAD83). CONTOUR INTERVAL IS ONE METRE.
4. INSTRUMENTATION LOCATIONS ARE BASED ON RECORDS PROVIDED BY TECK PERSONNEL FOR THIS REPORT. NO ATTEMPT HAS BEEN MADE TO VERIFY THE ACCURACY OF THE LOCATIONS.

LEGEND:

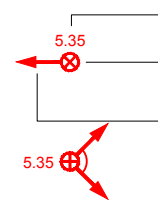

LOCATION AND DIRECTION OF PHOTOGRAPHS TAKEN DURING ANNUAL INSPECTION
 PHOTO NUMBER
 LOCATION WHERE PHOTO WAS TAKEN
 DIRECTION OF VIEW
 PANORAMA

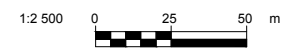

| | | |
|--|---|--|
| <p>AS A MUTUAL PROTECTION TO OUR CLIENT, THE PUBLIC AND OURSELVES, ALL REPORTS AND DRAWINGS ARE SUBMITTED FOR THE CONFIDENTIAL INFORMATION OF OUR CLIENT FOR A SPECIFIC PROJECT AND AUTHORIZATION FOR USE AND/OR PUBLICATION OF DATA STATEMENTS, CONCLUSIONS OR ABSTRACTS FROM OR REGARDING OUR REPORTS AND DRAWINGS IS RESERVED PENDING OUR WRITTEN APPROVAL.</p> | <p>CLIENT</p> <p>Teck</p> <p>Klohn Crippen Berger</p> | <p>PROJECT</p> <p>SULLIVAN MINE 2017 DAM SAFETY INSPECTION</p> |
| | <p>TITLE</p> <p>INSTRUMENT LOCATION PLAN NORTH EAST GYPSUM DIKE AND RECYCLE DAM</p> | <p>PROJECT No.</p> <p>A05807A17</p> |
| | | <p>FIG No.</p> <p>FIGURE 14</p> |

KCC-DB

\\int.klbn.com\ProjData\ALCGY\Alberta\A05807A17 TML Sullivan Mine 2017 DSI\400 Drawings\400 Drawings (2016 Copy)\Figure 15_NEGyp Section.dwg Layout=Figure 15 September 18, 2017 4:33:47 PM

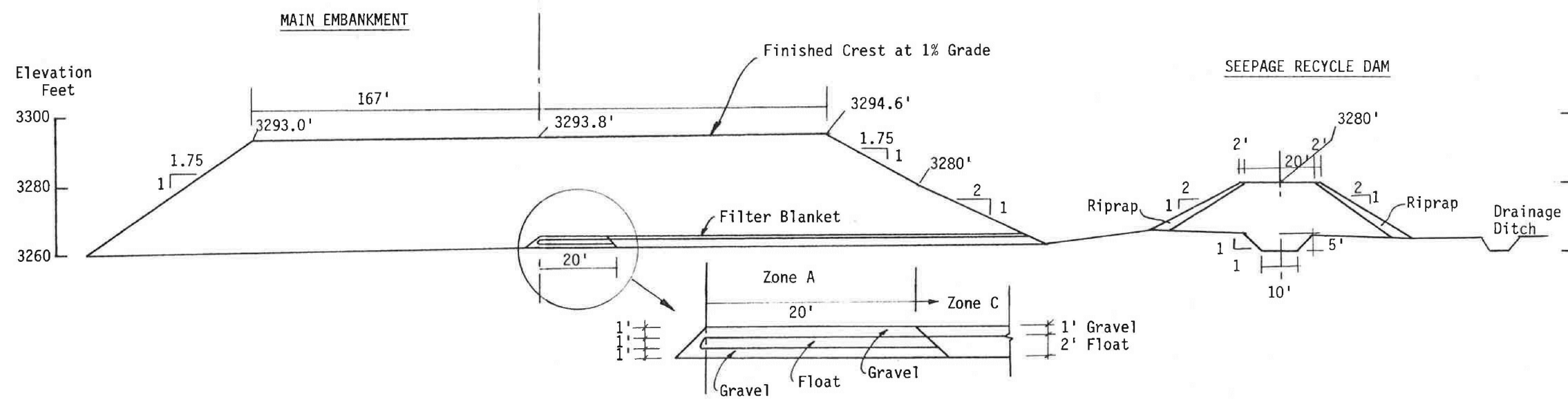

J SECTION
 FIG 14 SCALE = N.T.S.

| | | | |
|--|---|--|---------------------------------|
| AS A MUTUAL PROTECTION TO OUR CLIENT, THE PUBLIC AND OURSELVES, ALL REPORTS AND DRAWINGS ARE SUBMITTED FOR THE CONFIDENTIAL INFORMATION OF OUR CLIENT FOR A SPECIFIC PROJECT AND AUTHORIZATION FOR USE AND/OR PUBLICATION OF DATA, STATEMENTS, CONCLUSIONS OR ABSTRACTS FROM OR REGARDING OUR REPORTS AND DRAWINGS IS RESERVED PENDING OUR WRITTEN APPROVAL. | Teck | PROJECT SULLIVAN MINE 2017 DAM SAFETY INSPECTION | |
| |  | TITLE NORTHEAST GYPSUM DIKE AND RECYLCE DAM TYPICAL SECTION | |
| | | | PROJECT No. A05807A17 |

KCC-DB

Z:\ACGY\Alberta\A05807A17 TML Sullivan Mine 2017 DSI\400 Drawings\Figure 16 ARD.dwg Layout=Figure 16 October 27, 2017 10:02:01 AM

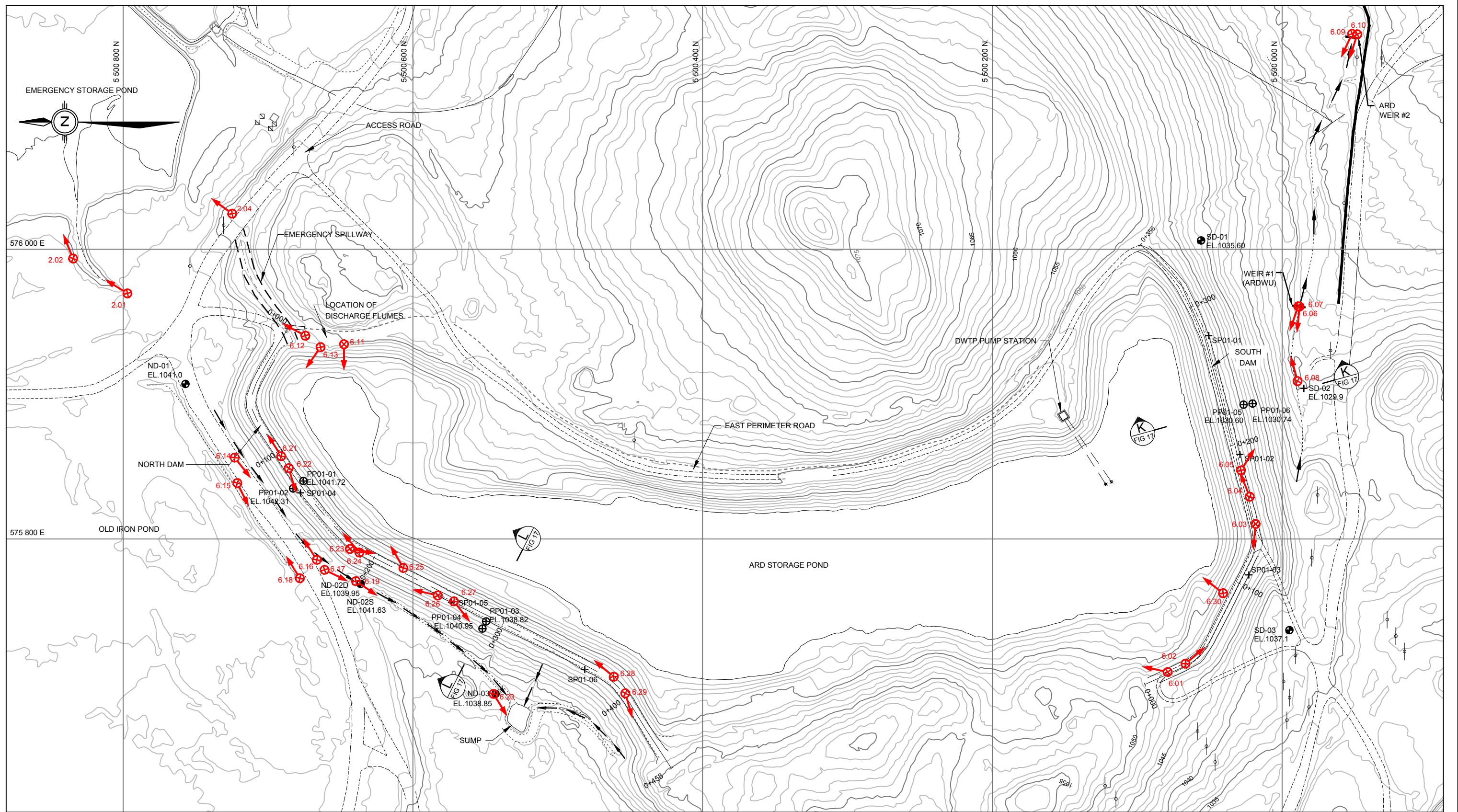

NOTES:

1. GENERAL TOPOGRAPHY FROM LIDAR DATED DECEMBER 2012.
2. ELEVATIONS ARE GEODETIC.
3. MAP COORDINATE SYSTEM = U.T.M. (NAD 83).

LEGEND:

- PNEUMATIC PIEZOMETER
- STANDPIPE PIEZOMETER
- SETTLEMENT PIN
- SEEPAGE COLLECTOR DITCH
- EL. 1032.1 MAXIMUM RECORDED PIEZO LEVEL (m) DURING REPORTING PERIOD

LOCATION AND DIRECTION OF PHOTOGRAPHS TAKEN DURING ANNUAL INSPECTION

- PHOTO NUMBER
- LOCATION WHERE PHOTO WAS TAKEN
- DIRECTION OF VIEW
- PANORAMA



AS A MUTUAL PROTECTION TO OUR CLIENT, THE PUBLIC AND OURSELVES, ALL REPORTS AND DRAWINGS ARE SUBMITTED FOR THE CONFIDENTIAL INFORMATION OF OUR CLIENT FOR A SPECIFIC PROJECT AND AUTHORIZATION FOR USE AND/OR PUBLICATION OF DATA STATEMENTS, CONCLUSIONS OR ABSTRACTS FROM OR REGARDING OUR REPORTS AND DRAWINGS IS RESERVED PENDING OUR WRITTEN APPROVAL.

| | |
|--|--------|
| | CLIENT |
| | |

| | | | |
|-------------|-----------|---|-----------|
| PROJECT | | SULLIVAN MINE 2017 DAM SAFETY INSPECTION | |
| TITLE | | ARD STORAGE POND PLAN AND LAYOUT | |
| PROJECT No. | A05807A17 | FIG No. | FIGURE 16 |

KCC08

Z:\ACGY\Alberta\A05807A17 TML Sullivan Mine 2017 DSI\400 Drawings\Figure 17_ARD Sections.dwg Layout=Figure 17 October 27, 2017 10:05:59 AM

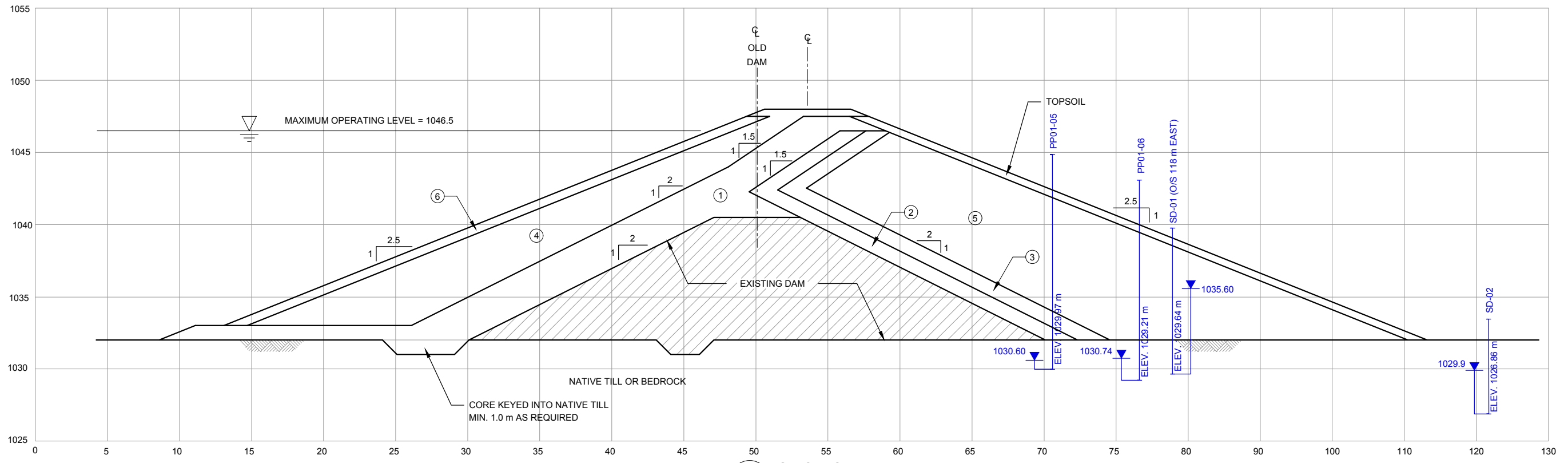

K SECTION
FIG 16 SCALE = 300

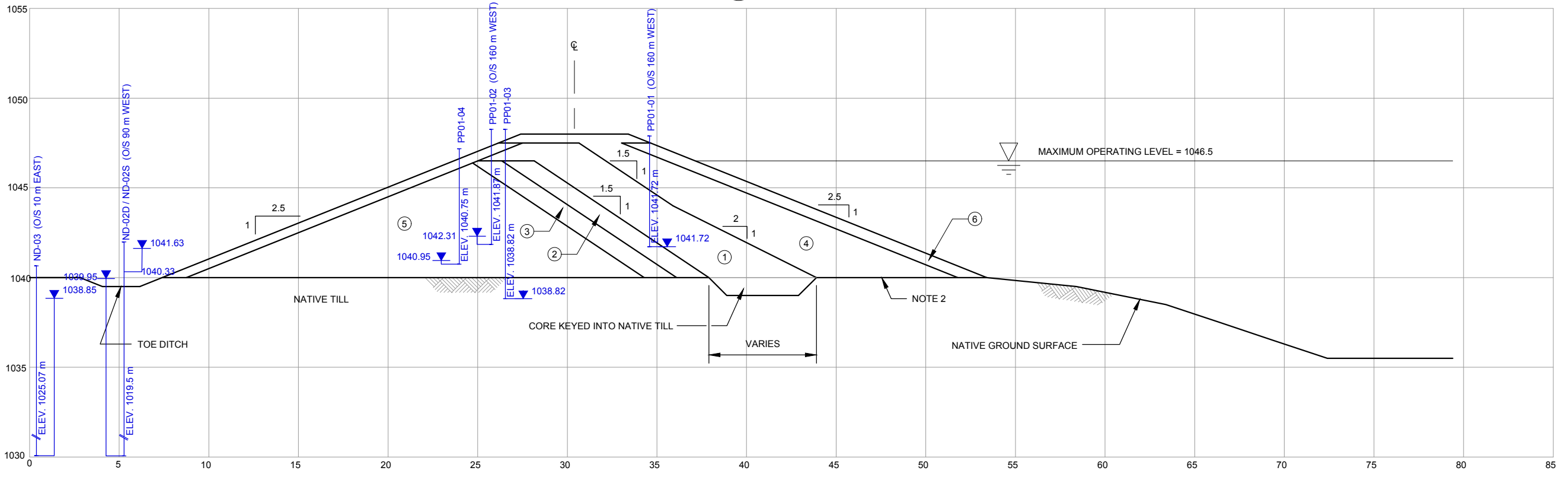

L SECTION
FIG 16 SCALE = 1:300

LEGEND:

| LEGEND: | | ZONE | MATERIALS |
|---------|--|------|------------------------|
| ⊕ | PNEUMATIC PIEZOMETER | ① | GLACIAL TILL |
| ⊙ | STANDPIPE PIEZOMETER | ② | SAND FILTER |
| + | SETTLEMENT PIN | ③ | SAND AND GRAVEL FILTER |
| → | TOE DITCH | ④ | SAND AND GRAVEL |
| 1023.7 | MAXIMUM RECORDED PIEZO LEVEL (m) DURING REPORTING PERIOD | ⑤ | FLOAT ROCK |
| | | ⑥ | RIPRAP |

NOTES:

1. UNITS ARE IN METERS, UNLESS INDICATED OTHERWISE ON FIGURE.
2. SITE LAYOUT PLAN WAS DEVELOPED FROM DRAWING B-8304, IN REPORT TITLED "SULLIVAN MINE TAILINGS FACILITY STORAGE POND NO. 1 - CONSTRUCTION RECORD REPORT" DATED JANUARY 2002 BY KLOHN CRIPPEN.
3. SECTION A & B WERE GENERATED FROM DRAWINGS B-2716-06-211 & B2716-06-210, RESPECTIVELY, IN REPORT TITLED "SULLIVAN MINE GEOTECHNICAL DESIGN BASIS FOR TAILINGS DIKES - OVERVIEW SUMMARY REPORT" DATED JANUARY 2002 BY KLOHN CRIPPEN.
4. FOUNDATION AREA OF THE DAM WAS CLEARED, GRUBBED AND STRIPPED TO COMPETENT TILL OR BEDROCK.
5. KEY TRENCH EXCAVATED MIN. 1.0 m INTO TILL

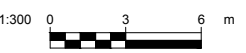

| | | |
|---|---|--|
| <p>AS A MUTUAL PROTECTION TO OUR CLIENT, THE PUBLIC AND OURSELVES, ALL REPORTS AND DRAWINGS ARE SUBMITTED FOR THE CONFIDENTIAL INFORMATION OF OUR CLIENT FOR A SPECIFIC PROJECT AND AUTHORIZATION FOR USE AND/OR PUBLICATION OF DATA, STATEMENTS, CONCLUSIONS OR ABSTRACTS FROM OR REGARDING OUR REPORTS AND DRAWINGS IS RESERVED PENDING OUR WRITTEN APPROVAL.</p> | <p>CLIENT</p> <p>Teck</p> <p>Klohn Crippen Berger</p> | <p>PROJECT</p> <p>SULLIVAN MINE 2017 DAM SAFETY INSPECTION</p> |
| | | <p>TITLE</p> <p>ARD STORAGE POND TYPICAL SECTIONS</p> |
| | | <p>PROJECT No.</p> <p>A05807A17</p> |
| | | <p>FIG No.</p> <p>FIGURE 17</p> |

KCC-DB



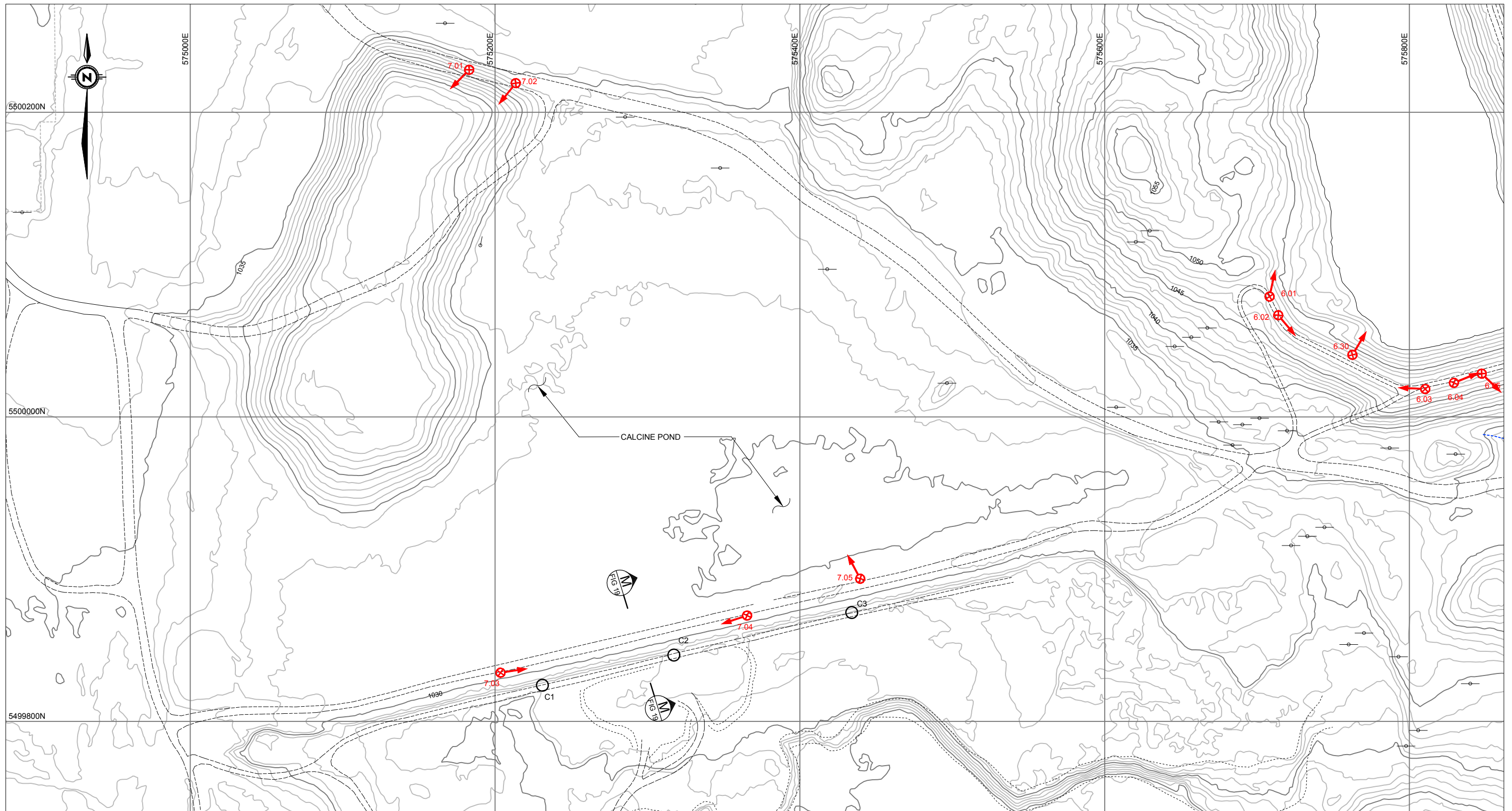



\\int.klobn.com\Proj\Data\ALCS\Y\alberta\A05807A17 TML Sullivan Mine 2017 DSI\400 Drawings\400 Drawings (2016 Copy)\Figure 18_Calcine.dwg Layout\Figure 18 October 16, 2017 4:54:37 PM





NOTES:

1. GENERAL TOPOGRAPHY FROM LIDAR DATED DECEMBER 2012.
2. ELEVATIONS ARE GEODETIC.
3. MAP COORDINATE SYSTEM = U.T.M. (NAD83). CONTOUR INTERVAL IS ONE METRE.
4. INSTRUMENTATION LOCATIONS ARE BASED ON RECORDS PROVIDED BY TECK PERSONNEL FOR THIS REPORT. NO ATTEMPT HAS BEEN MADE TO VERIFY THE ACCURACY OF THE LOCATIONS.

LEGEND:

-  C1 MONITORING WELL - ABANDONED
-  C2 MONITORING WELL - ABANDONED
-  C3 MONITORING WELL - ABANDONED
-  PHOTO NUMBER
-  LOCATION WHERE PHOTO WAS TAKEN
-  DIRECTION OF VIEW
-  PANORAMA



| | | | |
|---|--|--|--|
| AS A MUTUAL PROTECTION TO OUR CLIENT, THE PUBLIC AND OURSELVES, ALL REPORTS AND DRAWINGS ARE SUBMITTED FOR THE CONFIDENTIAL INFORMATION OF OUR CLIENT FOR A SPECIFIC PROJECT AND AUTHORIZATION FOR USE AND/OR PUBLICATION OF DATA STATEMENTS, CONCLUSIONS OR ABSTRACTS FROM OR REGARDING OUR REPORTS AND DRAWINGS IS RESERVED PENDING OUR WRITTEN APPROVAL. | CLIENT   | PROJECT SULLIVAN MINE 2017 DAM SAFETY INSPECTION | |
| | TITLE INSTRUMENT LOCATION PLAN CALCINE POND DIKE | | |
| PROJECT No. A05807A17 | | FIG No. FIGURE 18 | |

KCC-DB

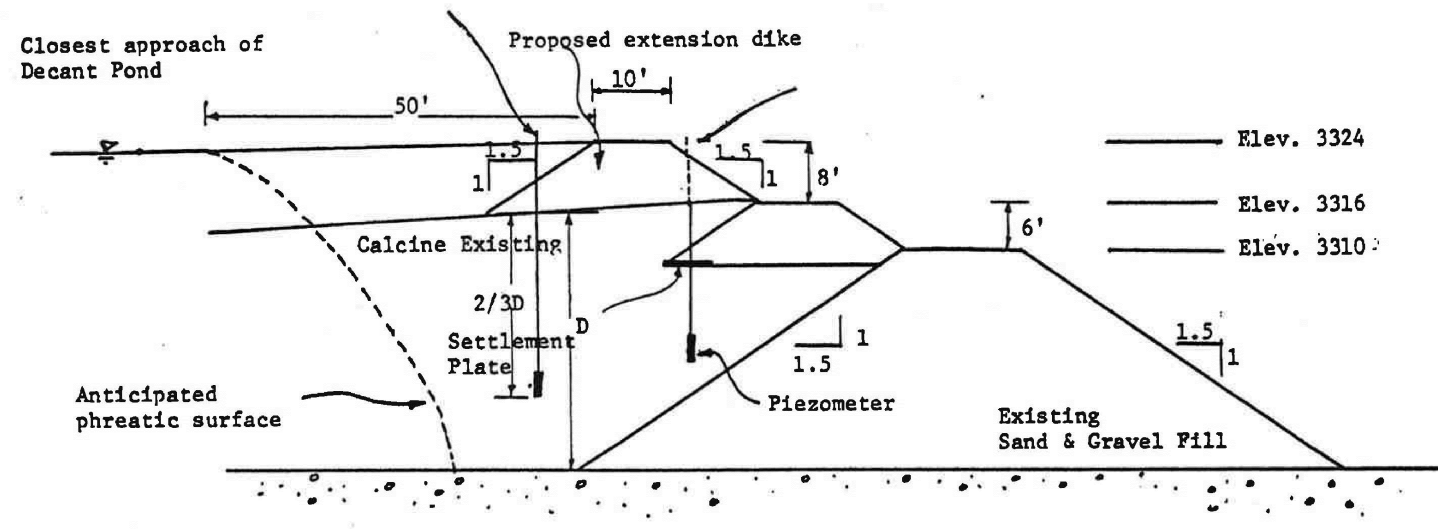

M SECTION
 FIG 18 SCALE = N.T.S.

I:\nt.klhn.com\ProjData\ACGY\Alberta\A05807A17 TML Sullivan Mine 2017 DSI\400 Drawings\400 Drawings (2016 Copy)\Figure 19 Calcine Section.dwg Layout\Figure 19 September 18, 2017 4:48:17 PM

| | | | |
|--|--|--|-------------------|
| AS A MUTUAL PROTECTION TO OUR CLIENT, THE PUBLIC AND OURSELVES, ALL REPORTS AND DRAWINGS ARE SUBMITTED FOR THE CONFIDENTIAL INFORMATION OF OUR CLIENT FOR A SPECIFIC PROJECT AND AUTHORIZATION FOR USE AND/OR PUBLICATION OF DATA, STATEMENTS, CONCLUSIONS OR ABSTRACTS FROM OR REGARDING OUR REPORTS AND DRAWINGS IS RESERVED PENDING OUR WRITTEN APPROVAL. | CLIENT <h1 style="margin: 0;">Teck</h1> | PROJECT SULLIVAN MINE 2017 DAM SAFETY INSPECTION | |
| | | TITLE CALCINE POND DIKE TYPICAL SECTION | |
| | | PROJECT No. A05807A17 | FIG No. FIGURE 19 |

KCC-B

I:\nt.kohn.com\Proj\Data\ACGY\Alberta\A06807A\17 TML Sullivan Mine 2017 DSI\400 Drawings\400 Drawings (2016 Copy)\Figure 20_Sludge.dwg Layout\Figure 20 September 18, 2017 4:51:12 PM

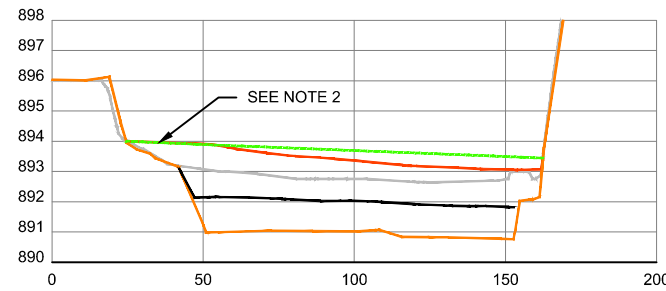

N SECTION
SCALE = 1:2500

NOTE: EXCESS SLUDGE DEPOSIT RELOCATED OCTOBER 2015

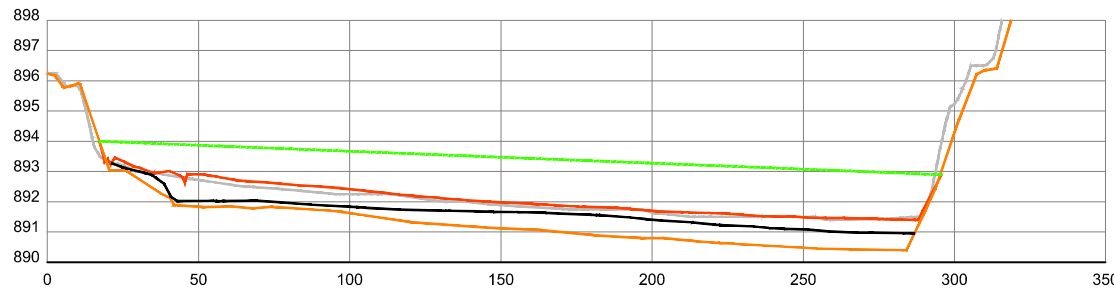

P SECTION
SCALE = 1:2500

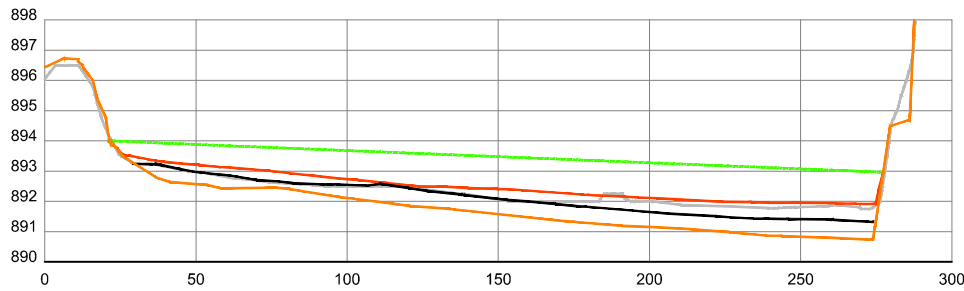

O SECTION
SCALE = 1:2500

VOLUME SUMMARY

2001 SURVEY TO FULL POOL @ 0.4% GRADIENT ~ 278,000 cu.m.
 2001 (MAY 8) SURVEY TO 2009 (SEPT 18) ~ 52,430 cu.m.
 2012 LIDAR SURFACE TO FULL POOL ~ 182,550 cu.m.
 2015 SURFACE TO FULL POOL ~ 163,630 cu.m.

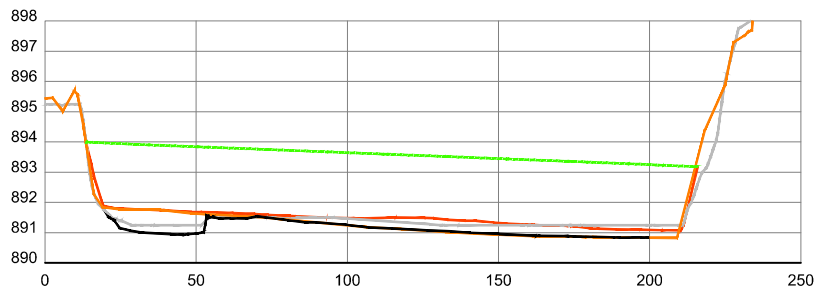

Q SECTION
SCALE = 1:2500

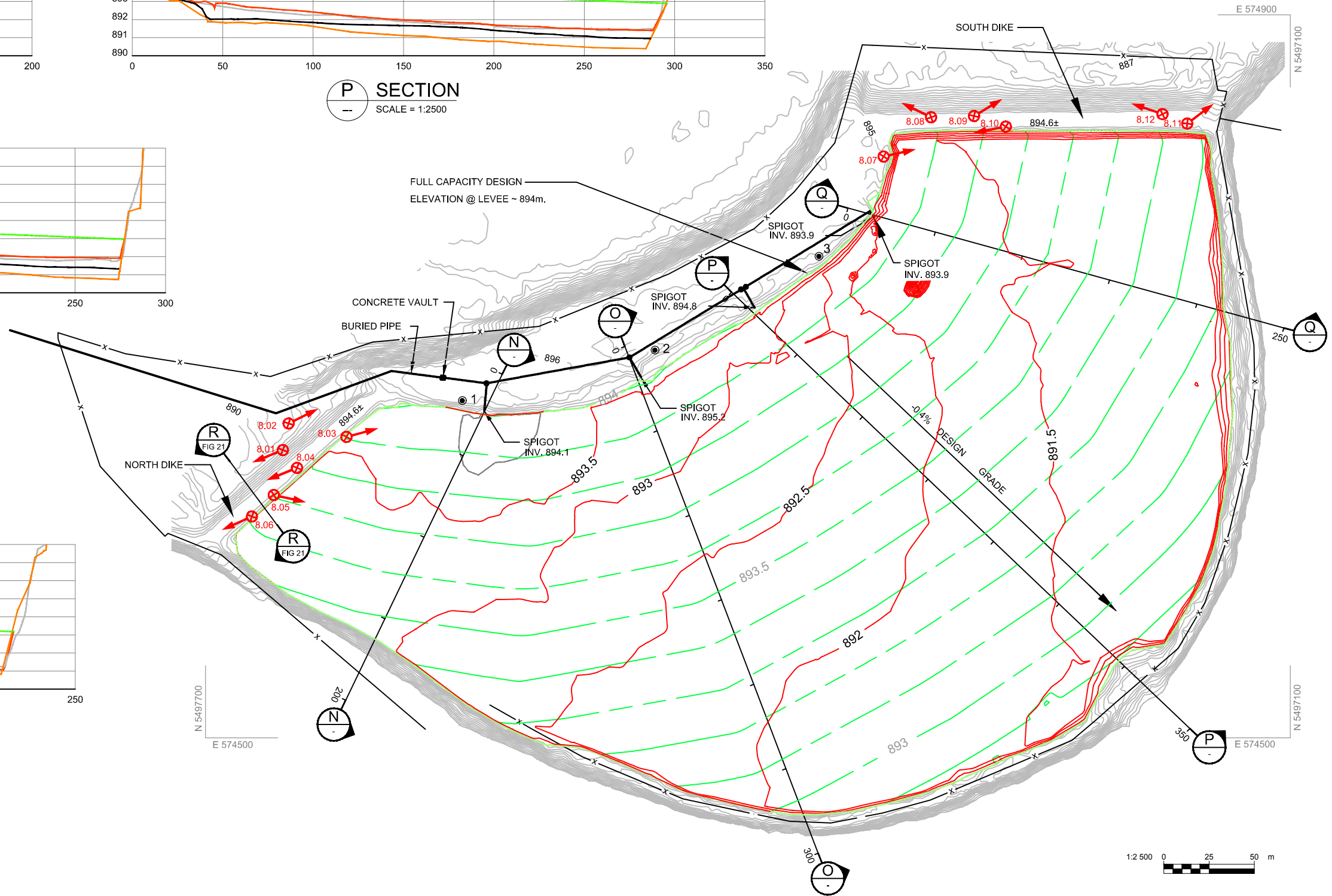

LEGEND:

- LOCATION AND DIRECTION OF PHOTOGRAPHS TAKEN DURING 2015 INSPECTION
- PHOTO NUMBER
- LOCATION WHERE PHOTO WAS TAKEN
- DIRECTION OF VIEW

- 2001 SURFACE
- 2009 SURVEY
- 2012 LIDAR SURVEY
- 2015 SURVEY (INTERVAL 0.5m)
- FULL POOL DESIGN SURFACE (INTERVAL 0.25m)
- FULL POOL PERIMETER (128,500 sq.m.)
- DENOTES SHUT OFF STANDPIPE
- 1 CONTROL MONUMENT PLACED 2015

NOTES:

1. SLUDGE POND LAYOUT AND CROSS SECTIONS PROVIDED BY TM TECH SERVICES, DRAWING NO. K101A2243 DATED SEPTEMBER 9 2015.
2. EXCESS SLUDGE AT SPIGOT NO. 1 RELOCATED OCTOBER 27, 2015.

| | | |
|--|--------------------------|---|
| AS A MUTUAL PROTECTION TO OUR CLIENT, THE PUBLIC AND OURSELVES, ALL REPORTS AND DRAWINGS ARE SUBMITTED FOR THE CONFIDENTIAL INFORMATION OF OUR CLIENT FOR A SPECIFIC PROJECT AND AUTHORIZATION FOR USE AND/OR PUBLICATION OF DATA, STATEMENTS, CONCLUSIONS OR ABSTRACTS FROM OR REGARDING OUR REPORTS AND DRAWINGS IS RESERVED PENDING OUR WRITTEN APPROVAL. | Teck | CLIENT SULLIVAN MINE 2017 DAM SAFETY INSPECTION |
| | | PROJECT SLUDGE POND DIKES PLAN |
| | PROJECT No. A05807A17 | FIG No. FIGURE 20 |

KCC008

\\int.klhn.com\ProjData\ACGY\Alberta\A05807A17 TML Sullivan Mine 2017 DSI\400 Drawings\400 Drawings (2016 Copy)\Figure 21 Sludge Typical Section.dwg Layout=Figure 21 September 18, 2017 4:53:01 PM

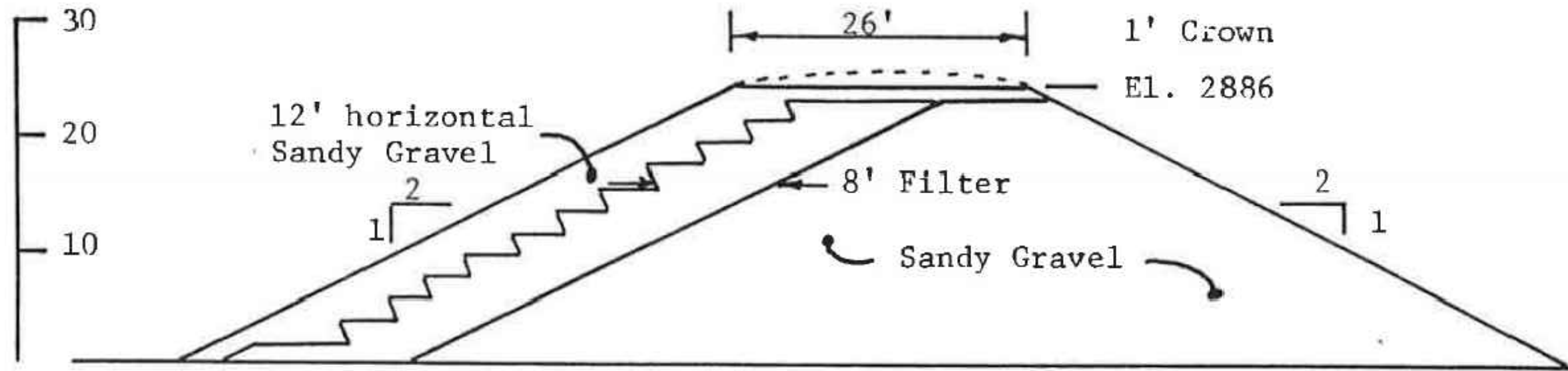

AS CONSTRUCTED

R SECTION
FIG 20 SCALE = N.T.S.

| | | | |
|---|-------------|---|-----------|
| <small>AS A MUTUAL PROTECTION TO OUR CLIENT, THE PUBLIC AND OURSELVES, ALL REPORTS AND DRAWINGS ARE SUBMITTED FOR THE CONFIDENTIAL INFORMATION OF OUR CLIENT FOR A SPECIFIC PROJECT AND AUTHORIZATION FOR USE AND/OR PUBLICATION OF DATA, STATEMENTS, CONCLUSIONS OR ABSTRACTS FROM OR REGARDING OUR REPORTS AND DRAWINGS IS RESERVED PENDING OUR WRITTEN APPROVAL.</small> | CLIENT | PROJECT | |
| | Teck | SULLIVAN MINE 2017 DAM SAFETY INSPECTION | |
| | | TITLE | |
| | | SLUDGE POND DIKES TYPICAL SECTION | |
| | | PROJECT No. | FIG No. |
| | | A05807A17 | FIGURE 21 |

KCC-B

APPENDIX I

2017 Dam Safety Inspection Forms

**Kimberley Inspection Checklist
Emergency Storage Pond (Iron Dyke)**

Date: 2:30pm
May 10, 2017

Inspected by: Same

Weather: Same

Pond Elevation ~ check readings ~ 1038

Any snow on the ground: Yes/ No Yes

Operational Limits: 1037.6m to 1038.9m

| IRON DYKE | Remarks |
|-------------------------------------|---------------------|
| Dam Crest Surface | |
| Cracks | No |
| Erosion | No |
| Settlement/depressions | No |
| Vegetation growth | yes, minor good. |
| Animal activity (rodent burrows) | No |
| Any unusual conditions | No |
| ponding of water | No |
| Dam Upstream Slope | |
| Slope protection (riprap) | N/A |
| Surface erosion/gullyng | No |
| Slides or sloughing | No |
| Settlement/depressions | No |
| Bulging | No |
| Cracks | No |
| Vegetation growth | Yes, grass / shrubs |
| Animal activity (rodent burrows) | No |
| Any unusual conditions | No |
| Dam Downstream Slope and Toe | |
| Slope protection (grass) | Yes |
| Surface erosion/gullyng | No |
| Slides or sloughing | No |
| Settlement/depressions | No |
| Bulging | No |

Kimberley Inspection Checklist Emergency Storage Pond (Iron Dyke)

| IRON DYKE | Remarks |
|----------------------------------|---|
| Cracks | No |
| Vegetation growth | Yes, grass, shrubs (good) |
| Animal activity (rodent burrows) | No |
| Seepage/wet areas | Seepage along west ^{east} toe by trees / toe ditch. ^{west by} Weirs. |
| Any unusual conditions | No |
| Seepage Summary | |
| Weir 3 (N/S) New | Cloudy/discoloured seepage <input checked="" type="radio"/> Yes / <input type="radio"/> No Red, higher than 2016 |
| Weir 4 (S/S) Old | Cloudy/discoloured seepage <input checked="" type="radio"/> Yes / <input type="radio"/> No Red Seepage, higher than 2016. |
| Cloudy/discoloured seepage? | Yes (Red/rust coloured). |

Notes:

Main Spillway

- midway near west Gypsum pond looks good
- culverts at base of spillway by west Gypsum pond look good.
- some vegetation in/above rock near base of spillway
 - Ask Reza if it should be removed.

Up by ESP

- Water pipeline & ditch may require moving if dike is going to be raised.

* Road by spillway crest needs to be lowered. *

Dike on west side of road to be raised. to 1044m if iron dike is going to be raised.

↳ Recommend survey of crest and this small "Dike" as part of ARD storage work.

Kimberley Inspection Checklist Old Iron Pond (South East Limb)

Date: May 10, 2017 @ 1:30 pm

Inspected by: Same

Weather: Same

Any snow on the ground: Yes/ No

| Observations | Remarks | |
|-------------------------------------|--|--|
| Dam Crest Surface | <div style="font-size: 4em; font-weight: bold;">/</div> <p style="font-size: 1.5em;">all good.</p> | |
| Cracks | | |
| Erosion | | |
| Settlement/depressions | | |
| Vegetation growth | | |
| Animal activity (rodent burrows) | | |
| Any unusual conditions | | |
| ponding of water | | |
| Dam Upstream Slope | | <div style="font-size: 4em; font-weight: bold;">/</div> <p style="font-size: 1.5em;">No changes from last year</p> <p style="font-size: 1.5em;">May want to remove from report since its just a road and does not really retain anymore.</p> |
| Slope protection (riprap) | | |
| Surface erosion/gullying | | |
| Slides or sloughing | | |
| Settlement/depressions | | |
| Bulging | | |
| Cracks | | |
| Vegetation growth | | |
| Animal activity (rodent burrows) | | |
| Any unusual conditions | | |
| Dam Downstream Slope and Toe | <div style="font-size: 4em; font-weight: bold;">/</div> <p style="font-size: 1.5em;">See notes on other side</p> | |
| Slope protection (grass) | | |
| Surface erosion/gullying | | |
| Slides or sloughing | | |
| Settlement/depressions | | |
| Bulging | | |

**Kimberley Inspection Checklist
Old Iron Pond (South East Limb)**

| Observations | Remarks |
|----------------------------------|----------------------|
| Cracks | <i>See below</i> |
| Vegetation growth | |
| Animal activity (rodent burrows) | |
| Seepage/wet areas | |
| Any unusual conditions | |

Notes:

2m Raiser
Notes

- ditch / culvert from South East limb to ESP
- would require extension on Culvert
- would need to move water pipeline

Kimberley Inspection Checklist Old Iron Pond (South West Limb)

Date: May 10, 2017 @ 1:55pm

Inspected by: Same

Weather: Same

Any snow on the ground: Yes/ No

| Observations | Remarks |
|-------------------------------------|---------------------------------|
| Dam Crest Surface | |
| Cracks | No |
| Erosion | No |
| Settlement/depressions | No |
| Vegetation growth | Minor |
| Animal activity (rodent burrows) | No |
| Any unusual conditions | No |
| ponding of water | No |
| Dam Upstream Slope | |
| Slope protection (riprap) | N/A |
| Surface erosion/gullying | No |
| Slides or sloughing | No |
| Settlement/depressions | No |
| Bulging | No |
| Cracks | No |
| Vegetation growth | Yes but protective / separating |
| Animal activity (rodent burrows) | No |
| Any unusual conditions | No |
| Dam Downstream Slope and Toe | |
| Slope protection (grass) | Yes |
| Surface erosion/gullying | No |
| Slides or sloughing | No |
| Settlement/depressions | No |
| Bulging | No |

Kimberley Inspection Checklist
Old Iron Pond (South West Limb)

| Observations | Remarks |
|----------------------------------|-----------------------|
| Cracks | No |
| Vegetation growth | Yes, minimal but good |
| Animal activity (rodent burrows) | No |
| Seepage/wet areas | No |
| Any unusual conditions | No |

Notes:

No observations that are out of the ordinary.

Kimberley Inspection Checklist No. 1 Siliceous Pond

Date: May 11, 2017 @ 10:00am

Inspected by: Ward Alger / Karen Masterson

Weather: Cloudy, possible rain

Any snow on the ground: Yes/No No

| Observations | Remarks |
|-------------------------------------|-------------------|
| Dam Crest Surface | <i>N/A</i> |
| Cracks | No |
| Erosion | No |
| Settlement/depressions | No |
| Vegetation growth | Yes, grass growth |
| Animal activity (rodent burrows) | No |
| Any unusual conditions | No |
| ponding of water | No |
| Dam Upstream Slope | |
| Slope protection (riprap) | N/A |
| Surface erosion/gullyng | No |
| Slides or sloughing | No |
| Settlement/depressions | No |
| Bulging | No |
| Cracks | No |
| Vegetation growth | Yes, grass growth |
| Animal activity (rodent burrows) | No |
| Any unusual conditions | No |
| Dam Downstream Slope and Toe | |
| Slope protection (grass) | Yes, grass growth |
| Surface erosion/gullyng | No |
| Slides or sloughing | No |
| Settlement/depressions | No |
| Bulging | No |
| Cracks | No |

**Kimberley Inspection Checklist
No. 1 Siliceous Pond**

| Observations | Remarks |
|----------------------------------|------------|
| Vegetation growth | Yes, grass |
| Animal activity (rodent burrows) | No |
| Seepage/wet areas | No |
| Any unusual conditions | No |

Notes:

Ditch (upstream) of Siliceous Ponds:
riprap looks in good condition

Kimberley Inspection Checklist No. 2 Siliceous Pond

Date: May 11, 2017 @ 11:00

Inspected by: Ward A/Kawa M

Weather: Rainy

Any snow on the ground: Yes/ No

| Observations | Remarks |
|-------------------------------------|-----------------------------|
| Dam Crest Surface | |
| Cracks | No |
| Erosion | No |
| Settlement/depressions | No |
| Vegetation growth | Yes, minor |
| Animal activity (rodent burrows) | No |
| Any unusual conditions | No |
| ponding of water | No |
| Dam Upstream Slope | |
| Slope protection (riprap) | N/A |
| Surface erosion/gullyng | No |
| Slides or sloughing | No |
| Settlement/depressions | No |
| Bulging | No |
| Cracks | No |
| Vegetation growth | Yes, minor grass |
| Animal activity (rodent burrows) | No |
| Any unusual conditions | No |
| Dam Downstream Slope and Toe | |
| Slope protection (grass) | Yes |
| Surface erosion/gullyng | No |
| Slides or sloughing | No |
| Settlement/depressions | No |
| Bulging | No |

**Kimberley Inspection Checklist
No. 2 Siliceous Pond**

| Observations | Remarks |
|----------------------------------|---------|
| Cracks | No |
| Vegetation growth | Yes |
| Animal activity (rodent burrows) | No |
| Seepage/wet areas | No |
| Any unusual conditions | No |

Notes:

Ditch @ Top

- Seepage coming out along toe and collecting in ditch.

**Kimberley Inspection Checklist
No. 3 Siliceous Pond**

Date: May 11, 2012 @ 10:15 am

Inspected by: Wendy A / Karen M

Weather: rain clouds

Any snow on the ground: Yes No

| Observations | Remarks |
|-------------------------------------|------------|
| Dam Crest Surface | |
| Cracks | No |
| Erosion | No |
| Settlement/depressions | No |
| Vegetation growth | Yes, grass |
| Animal activity (rodent burrows) | No |
| Any unusual conditions | No |
| ponding of water | No |
| Dam Upstream Slope | |
| Slope protection (riprap) | N/A |
| Surface erosion/gullying | No |
| Slides or sloughing | No |
| Settlement/depressions | No |
| Bulging | No |
| Cracks | No |
| Vegetation growth | Yes, grass |
| Animal activity (rodent burrows) | No |
| Any unusual conditions | No |
| Dam Downstream Slope and Toe | |
| Slope protection (grass) | Yes |
| Surface erosion/gullying | No |
| Slides or sloughing | No |
| Settlement/depressions | No |
| Bulging | No |

**Kimberley Inspection Checklist
No. 3 Siliceous Pond**

| Observations | Remarks |
|----------------------------------|------------|
| Cracks | No |
| Vegetation growth | Yes, grass |
| Animal activity (rodent burrows) | No |
| Seepage/wet areas | No |
| Any unusual conditions | No |

Notes:

Spillway

- riprap looks in good condition along end of
- spillway and above on dike / tailings
- grass along base of channel
which is on

Kimberley Inspection Checklist West Gypsum Pond

Date: May 10, 2017 @ 10:30

Inspected by: Same

Weather: Same

Any snow on the ground: Yes/ No

| Observations | Remarks |
|-------------------------------------|--|
| Dam Crest Surface | |
| Cracks | NO |
| Erosion | No |
| Settlement/depressions | NO |
| Vegetation growth | yes (good vegetation) |
| Animal activity (rodent burrows) | No |
| Any unusual conditions | No |
| ponding of water | NO |
| Dam Upstream Slope | |
| Slope protection (riprap) | N/A |
| Surface erosion/gullying | NO |
| Slides or sloughing | NO |
| Settlement/depressions | No |
| Bulging | No |
| Cracks | No |
| Vegetation growth | Yes but good vegetation |
| Animal activity (rodent burrows) | No |
| Any unusual conditions | No. |
| Dam Downstream Slope and Toe | |
| Slope protection (grass) | grass growing all along along b/s slope. |
| Surface erosion/gullying | No |
| Slides or sloughing | NO |
| Settlement/depressions | No |
| Bulging | No |

Kimberley Inspection Checklist West Gypsum Pond

| Observations | Remarks |
|----------------------------------|--|
| Cracks | No |
| Vegetation growth | grasses and some small shrubs / cleared out |
| Animal activity (rodent burrows) | gopher holes seen along toe in localized areas |
| Seepage/wet areas | No |
| Any unusual conditions | No |

Notes:

West Gypsum spillway looks good.

- pumphouse @ base of west Gypsum looks good
- pond near pumphouse looks good.
- gopher holes closer to west/middle of dike toe.
- possible toe bulging near east end?
 - could it be bedrock that's just been grown over?

Kimberley Inspection Checklist East Gypsum Pond

Date: May 10, 2017 @ 11:15am

Inspected by: Same

Weather: Same

Any snow on the ground: Yes/No No

| Observations | Remarks |
|-------------------------------------|--------------------------------------|
| Dam Crest Surface | |
| Cracks | No |
| Erosion | No |
| Settlement/depressions | No |
| Vegetation growth | Yes but good |
| Animal activity (rodent burrows) | No |
| Any unusual conditions | No |
| ponding of water | No |
| Dam Upstream Slope | |
| Slope protection (riprap) | N/A |
| Surface erosion/gullyng | No |
| Slides or sloughing | No |
| Settlement/depressions | No |
| Bulging | No |
| Cracks | No |
| Vegetation growth | Yes but good |
| Animal activity (rodent burrows) | No |
| Any unusual conditions | No |
| Dam Downstream Slope and Toe | |
| Slope protection (grass) | Grass all along D/S slope |
| Surface erosion/gullyng | None some along east end. |
| Slides or sloughing | No |
| Settlement/depressions | No |
| Bulging | No |

Kimberley Inspection Checklist East Gypsum Pond

| Observations | Remarks |
|------------------------------------|--|
| Cracks | No |
| Vegetation growth | Yes but good vegetation |
| * Animal activity (rodent burrows) | Gopher holes @ far west end & large hole in middle @ toe |
| Seepage/wet areas | |
| * Any unusual conditions | large animal holes along toe & within ditch |

Notes:

- Some animal tracks present (etc)
- ditch along west toe has water & algae (buildup)
 - May want to suggest cleaning.
- ditch along central portion toe has vegetation growing in
 - suggest it be cleaned
 - Water ponding and algae growth also in ditch.
 - very steep side slopes (steeper than 1:1)

* - Midway *

- large 1ft diameter hole. (liquid in the bottom)
- large rocks.
- these need to be filled! X 25 +
- install a camera?
- most likely animal digging out gophers.

- East end
- ditch is non-continuous
 - should it be re-shaped?
 - lots of grass growing in ditch.

More large holes further east w/in ditch. → animal digging out gophers.

Kimberley Inspection Checklist North/East Gypsum Dyke

Date: May 10, 2017 @ 4pm

Inspected by: Same

Weather: Same

Any snow on the ground: Yes/No No

| Observations | Remarks |
|-------------------------------------|---|
| Dam Crest Surface | |
| Cracks | No |
| Erosion | No |
| Settlement/depressions | No |
| Vegetation growth | yes, grass / shrubs |
| Animal activity (rodent burrows) | No |
| Any unusual conditions | No |
| ponding of water | No |
| Dam Upstream Slope | |
| Slope protection (riprap) | N/A |
| Surface erosion/gullyng | No |
| Slides or sloughing | No |
| Settlement/depressions | No |
| Bulging | No |
| Cracks | No |
| Vegetation growth | yes, grass + trees. (remove the trees) |
| Animal activity (rodent burrows) | geese |
| Any unusual conditions | |
| Dam Downstream Slope and Toe | |
| Slope protection (grass) | No |
| Surface erosion/gullyng | No Yes, surficial erosion on slope on pond side. |
| Slides or sloughing | No |
| Settlement/depressions | No |
| Bulging | No |

Kimberley Inspection Checklist
North/East Gypsum Dyke

| Observations | Remarks |
|----------------------------------|---------|
| Cracks | No |
| Vegetation growth | No |
| Animal activity (rodent burrows) | No |
| Seepage/wet areas | No |
| Any unusual conditions | no |

Notes:

Recycle Pond Splitter.

- In the same condition as last year

Gypsum Dike

- Some surface erosion on ponded water side

- Continue to remove trees.

Make sure report says low consequence.

Kimberley Inspection Checklist ARD Storage Pond

Date: May 10, 2017 @ 9am

Inspected by: Wendy Algar / Karen Masterson

Weather: Sunny; light breeze

Pond Elevation ± 1043m

Any snow on the ground: Yes/ No

Operational Limits: 1035m to 1046.5m

| North Dam | Remarks |
|-------------------------------------|---|
| Dam Crest Surface (1048m) | |
| Cracks | No |
| Erosion | No |
| Settlement/depressions | No |
| Vegetation growth | No |
| Animal activity (rodent burrows) | None visible |
| Any unusual conditions | No |
| ponding of water | No |
| Dam Upstream Slope | |
| Slope protection (riprap) | good |
| Surface erosion/gullying | none |
| Slides or sloughing | none |
| Settlement/depressions | none |
| Bulging | none |
| Cracks | none |
| Vegetation growth | minor, some wood/branches collected |
| Animal activity (rodent burrows) | holes |
| Any unusual conditions | none. |
| Dam Downstream Slope and Toe | |
| Slope protection (grass) | Yes, growth looks good |
| Surface erosion/gullying | None |
| Slides or sloughing | None |
| Settlement/depressions | Some along NW toe, may want to check down x 4 y |
| Bulging | None. |

Kimberley Inspection Checklist ARD Storage Pond

| North Dam | Remarks |
|----------------------------------|---|
| Cracks | None |
| Vegetation growth | None other than grass |
| Animal activity (rodent burrows) | Birds |
| Seepage/wet areas | wet area w/in ditch along NW toe. |
| Any unusual conditions | Some depressions on the NW toe that look like they may have been pipe outlets at one point. |

Notes:

ARD Storage project.
North dike
Raise

- ARD feed lines need to move
- Powerlines
- Spillway raised
- fill new road that heads east.

* Along West end *

- topo new road looks low
→ look @ model.
- Ask for survey along this area.
- Access will need to be adjusted
- Won't be able to have a road in this area.

Colverts from ARD spillway to ESP
→ In good condition

Pond @ NW corner for seepage collection would need to move

Kimberley Inspection Checklist ARD Storage Pond

Date: May 10, 2017 @ 8:30am

Inspected by: Ward Algar / Karen Masterson

Weather: Sunny, light breeze

Pond Elevation _____

Any snow on the ground: Yes No

Operational Limits: 1035m to 1046.5m

≈ 1043
CREST = 1048m

| South Dam | Remarks |
|-------------------------------------|--|
| Dam Crest Surface (1048m) | Appears to be in good condition |
| Cracks | None |
| Erosion | None |
| Settlement/depressions | None |
| Vegetation growth | Vegetation growing on u/s slope rip rap |
| Animal activity (rodent burrows) | Geese present, ducks in pond |
| Any unusual conditions | None |
| ponding of water | None |
| Dam Upstream Slope | |
| Slope protection (riprap) | good |
| Surface erosion/gullying | None some crossinal fractures on riprap near amphip. |
| Slides or sloughing | None |
| Settlement/depressions | None |
| Bulging | None |
| Cracks | None |
| Vegetation growth | Yes, minor |
| Animal activity (rodent burrows) | Ducks |
| Any unusual conditions | None |
| Dam Downstream Slope and Toe | |
| Slope protection (grass) | Yes |
| Surface erosion/gullying | None |
| Slides or sloughing | None |
| Settlement/depressions | None |
| Bulging | None |

Kimberley Inspection Checklist ARD Storage Pond

| South Dam | Remarks |
|----------------------------------|--|
| Cracks | None |
| Vegetation growth | Yes, along entire slope |
| Animal activity (rodent burrows) | None seen |
| Seepage/wet areas | None |
| Any unusual conditions | None. |
| Seepage Summary | |
| Weir 1 ARDW | Cloudy/dicoloured seepage Yes/No Clean water w/ algae. |
| Weir 2 | Cloudy/dicoloured seepage Yes/No <u>No</u> clear, flowing. |
| Cloudy/dicoloured seepage? | |

ARD Storage Pond Notes:

Dike Repair Notes

- pump house would need to be moved if raise above El. 1048 were to occur.
- South dike
 - powerlines/ditch/weir would need to be moved
- East dike
 - powerhouse/powerlines/waterline would need to be moved.

South Dike Toe

- Clean algae from ARDW
- Clean vegetation out of ditch.
- ARDW noticed to be higher than previous year.
 - Must be seepage through filter, but water seems clean
 - Maybe ask Tech to test the water to be sure.
- ARDW - clear flow

Kimberley Inspection Checklist Calcine Pond

Date: May 10, 2017 @ 2:15pm

Inspected by: Same.

Weather: Same

Any snow on the ground: Yes/No No

| Observations | Remarks |
|-------------------------------------|---------------------|
| Dam Crest Surface | |
| Cracks | No |
| Erosion | No |
| Settlement/depressions | No |
| Vegetation growth | Yes (common) |
| Animal activity (rodent burrows) | |
| Any unusual conditions | No |
| ponding of water | No |
| Dam Upstream Slope | |
| Slope protection (riprap) | N/A |
| Surface erosion/gullyng | No |
| Slides or sloughing | No |
| Settlement/depressions | No |
| Bulging | No |
| Cracks | No |
| Vegetation growth | Gross growth, trees |
| Animal activity (rodent burrows) | None visible |
| Any unusual conditions | No |
| Dam Downstream Slope and Toe | |
| Slope protection (grass) | trees |
| Surface erosion/gullyng | No |
| Slides or sloughing | No |
| Settlement/depressions | No |
| Bulging | No |

**Kimberley Inspection Checklist
Calcine Pond**

| Observations | Remarks |
|----------------------------------|-------------------|
| Cracks | No |
| Vegetation growth | tree growth good. |
| Animal activity (rodent burrows) | No |
| Seepage/wet areas | No |
| Any unusual conditions | No |

Notes:
For potential storage of ARD.
Excavation Pit in Calcine Pond.

- remove all grass / topsoil or bring in a subgrade.
- remove any large rocks.

would need a fence to keep out animals.

Dike Crest

- stepped d/s slope.
- d/s slope to west has highest height difference
b/c no material in City Dump.

Kimberley Inspection Checklist DWTP Sludge Pond (North)

Date: May 11, 2017 @ 7:30am

Inspected by: Wendy Ngwen / Karen Markson

Weather: Overcast, possible rain clouds

Any snow on the ground: Yes No

| Observations | Remarks |
|-------------------------------------|---|
| Dam Crest Surface | |
| Cracks | No |
| Erosion | No |
| Settlement/depressions | Slight depressions on east end |
| Vegetation growth | yes, minor but good |
| Animal activity (rodent burrows) | No |
| Any unusual conditions | No |
| ponding of water | No |
| Dam Upstream Slope | |
| Slope protection (riprap) | N/A |
| Surface erosion/gullying | No |
| Slides or sloughing | No |
| Settlement/depressions | Slight settlement/depression along east end |
| Bulging | No |
| Cracks | No |
| Vegetation growth | Yes, grass, shrubs, (good) |
| Animal activity (rodent burrows) | No |
| Any unusual conditions | No |
| Dam Downstream Slope and Toe | |
| Slope protection (grass) | Yes, grass & shrubs |
| Surface erosion/gullying | No |
| Slides or sloughing | No |
| Settlement/depressions | see slight depression on east end of north side No |
| Bulging | No |

**Kimberley Inspection Checklist
DWTP Sludge Pond (North)**

| Observations | Remarks |
|----------------------------------|-------------------|
| Cracks | No |
| Vegetation growth | Yes, grass (good) |
| Animal activity (rodent burrows) | No |
| Seepage/wet areas | No |
| Any unusual conditions | |

Notes:

- * - Resurvey to sludge pond
- Should likely stop piling @ north end
- Should pay more along south dike.

Kimberley Inspection Checklist DWTP Sludge Pond (South)

Date: May 11, 2017 @ 8:am

Inspected by: Saw

Weather: Same

Any snow on the ground: Yes/No No

| Observations | Remarks |
|-------------------------------------|---|
| Dam Crest Surface | |
| Cracks | No |
| Erosion | No |
| Settlement/depressions | No slight depression @ south end |
| Vegetation growth | Yes, minor on edges |
| Animal activity (rodent burrows) | No |
| Any unusual conditions | No |
| ponding of water | No |
| Dam Upstream Slope | |
| Slope protection (riprap) | N/A |
| Surface erosion/gullying | No |
| Slides or sloughing | No |
| Settlement/depressions | Slight depression @ far south end of settler dikes. |
| Bulging | No |
| Cracks | No |
| Vegetation growth | Yes, grass / shrubs |
| Animal activity (rodent burrows) | No |
| Any unusual conditions | No |
| Dam Downstream Slope and Toe | |
| Slope protection (grass) | Yes + shrubs |
| Surface erosion/gullying | No |
| Slides or sloughing | No |
| Settlement/depressions | No |
| Bulging | No |

| Observations | Remarks |
|----------------------------------|-------------------|
| Cracks | No |
| Vegetation growth | Yes, grass (good) |
| Animal activity (rodent burrows) | No |
| Seepage/wet areas | No |
| Any unusual conditions | No |

Notes:

- Continue to remove trees from D/S slope if they grow back
- Raise/widen South end crest to design Min.

APPENDIX II

2017 Photographs

1. Iron Pond

Approximate locations and directions of photos are shown on Figures 3 and 4.



1.01: May 10, 2017



1.02: May 10, 2017 Seepage collecting at toe of dike.



1.03: May 10, 2017



1.04: May 10, 2017



1.05: May 10, 2017



1.06: May 10, 2017

1. Iron Pond



1.07: May 10, 2017



1.08: May 10, 2017



1.09: May 10, 2017



1.10: May 10, 2017



1.11: May 10, 2017



1.12: May 10, 2017

1. Iron Pond



1.13: May 10, 2017 Weir #4 (Old Weir)



1.14: May 10, 2017 Weir #4 (Old Weir)



1.15: May 10, 2017 Seepage collection ditch.



1.16: May 10, 2017 Weir #3 (AIPWU)



1.17: May 10, 2017 Seepage from toe of Iron Dike.

2. Iron Pond Emergency Storage Pond

Approximate locations and directions of photos are shown on Figures 6 and 16.



2.01: May 10, 2017



2.02: May 10, 2017



2.03: May 10, 2017 Seepage collection channel from Old Iron Pond



2.04: May 10, 2017 Culverts from ARD Spillway into Emergency Storage Pond

3. Southwest Limb and Southeast Limb of Iron Pond

Approximate locations and directions of photos are shown on Figure 6.



3.01: May 10, 2017



3.02: May 10, 2017



3.03: May 10, 2017



3.04: May 10, 2017



3.05: May 10, 2017

4. Siliceous Pond

Approximate locations and directions of photos are shown on Figure 8.



4.01: May 11, 2017 North surface water diversion channel



4.02: May 11, 2017 Siliceous Pond #1 Dike



4.03: May 11, 2017



4.04: May 11, 2017 Siliceous Pond #1 Dike



4.05: May 11, 2017 Ditch at toe of Siliceous Pond #2



4.06: May 11, 2017 Ditch at toe of Siliceous Pond #2

4. Siliceous Pond



4.07: May 11, 2017



4.08: May 11, 2017 Siliceous Pond #2 Dike



4.09: May 11, 2017 Siliceous Pond #3 Dike



4.10: May 11, 2017 Emergency Spillway



4.11: May 11, 2017 Siliceous Pond #3 Dike



4.12: May 11, 2017 Emergency Spillway

4. Siliceous Pond



4.13: May 11, 2017 Drainage channel from Dike #1 to Emergency Spillway.



4.14: May 11, 2017 Drainage channel from Dike #1 to Emergency Spillway



4.15: May 11, 2017



4.16: May 11, 2017 Siliceous Pond #3 Crest



4.17: May 11, 2017



4.18: May 11, 2017

4. Siliceous Pond



4.19: May 11, 2017

5. Gypsum Ponds and Recycle Dam

Approximate locations and directions of photos are shown on Figures 10, 12 and 14.



5.01: May 10, 2017 951 Pump house Pond



5.02: May 10, 2017 West Gypsum Dike Toe



5.03: May 10, 2017 Drainage channel from West Gypsum Dike toe



5.04: May 10, 2017



5.05: May 10, 2017 Rodent Burrows at Toe of West Gypsum Dike



5.06: May 10, 2017 James Creek collects seepage from toe of Gypsum dike

5. Gypsum Ponds and Recycle Dam



5.07: May 10, 2017



5.08: May 10, 2017 West Gypsum Dike crest



5.09: May 10, 2017



5.10: May 10, 2017



5.11: May 10, 2017



5.12: May 10, 2017

5. Gypsum Ponds and Recycle Dam



5.13: May 10, 2017 Rodent burrows



5.14: May 10, 2017



5.15: May 10, 2017 Ditch at toe of East Gypsum Dike



5.16: May 10, 2017 Ditch at toe of East Gypsum Dike



5.17: May 10, 2017



5.18: May 10, 2017 Large rodent burrows at toe of East Gypsum Dike

5. Gypsum Ponds and Recycle Dam



5.19: May 10, 2017 Rodent burrows upstream of ditch at dike toe



5.20: May 10, 2017



5.21: May 10, 2017



5.22: May 10, 2017 Rodent burrows in ditch at toe



5.23: May 10, 2017



5.24: May 10, 2017 East Gypsum Dike crest

5. Gypsum Ponds and Recycle Dam



5.25: May 10, 2017



5.26: May 10, 2017



5.27: May 10, 2017



5.28: May 10, 2017



5.29: May 10, 2017



5.30: May 10, 2017

5. Gypsum Ponds and Recycle Dam



5.31: May 10, 2017



5.32: May 10, 2017 Recycle Pond



5.33: May 10, 2017



5.34: May 10, 2017 Northeast Gypsum Dike



5.35: May 10, 2017

6. ARD Storage Pond

Approximate locations and directions of photos are shown on Figure 16 and 18.



6.01: May 1, 2017



6.02: May 10, 2017 Crest of ARD South Dike



6.03: May 10, 2017



6.04: May 10, 2017



6.05: May 10, 2017 Downstream slope of ARD South Dike



6.06: May 10, 2017 Weir #1 (ARDWU)

6. ARD Storage Pond



6.07: May 10, 2017 Algae build-up in (ARDWU)



6.08: May 10, 2017 Ditch at downstream toe of South Dike



6.09: May 10, 2017 ARD Weir #2



6.10: May 10, 2017 Ditch downstream of ARD Weir #2



6.11: May 10, 2017 Discharge Flumes



6.12: May 10, 2017 ARD Emergency Spillway

6. ARD Storage Pond



6.13: May 10, 2017 Upstream slope of North Dike



6.14: May 10, 2017 Downstream slope of North Dike



6.15: May 10, 2017 Drainage ditch downstream of North Dike toe.



6.16: May 10, 2017



6.17: May 10, 2017



6.18: May 10, 2017 Ditch downstream of North Dam along road.

6. ARD Storage Pond



6.19: May 10, 2017



6.20: May 10, 2017 Drainage collection pond at toe of North Dam



6.21: May 10, 2017 Crest of North Dike



6.22: May 10, 2017



6.23: May 10, 2017



6.24: May 10, 2017

6. ARD Storage Pond



6.25: May 10, 2017 Upstream slope of North Dike



6.26: May 10, 2017



6.27: May 10, 2017



6.28: May 10, 2017



6.29: May 10, 2017



6.30: May 10, 2017 ARD Pond and DWTP Pump Station

7. Calcine Pond

Approximate locations and directions of photos are shown on Figure 18.



7.01 May 10, 2017 Excavation within Calcine Pond



7.02 May 10, 2017 Excavation within Calcine Pond.



7.03 May 10, 2017 Calcine Pond Dike



7.04 May 10, 2017 Calcine Pond Dike



7.05 May 10, 2017

8. Sludge Pond

Approximate locations and directions of photos are shown on Figure 20.



8.01: May 11, 2017 Downstream slope of North Dike



8.02: May 11, 2017 North Dike access ramp



8.03: May 11, 2017 Crest of North Dike



8.04: May 11, 2017 Upstream slope of North Dike



8.05: May 11, 2017 Sludge Pond Surface



8.06: May 11, 2017

8. Sludge Pond



8.07: May 11, 2017 Upstream slope of South Dike



8.08: May 11, 2017 Downstream slope of South Dike



8.09: May 11, 2017



8.10: May 11, 2017



8.11: May 11, 2017 South end access road of South Dike



8.12: May 11, 2017

9. Emergency Storage Pond Spillway

Approximate locations and directions of photos are shown on Figures 3 and 10.



9.01: May 10, 2017 Spillway crest



9.02: May 10, 2017



9.03: May 10, 2017 Spillway channel



9.04: May 10, 2017 West Gypsum Emergency Spillway



9.05: May 10, 2017



9.06: May 10, 2017 Vegetation growing in Spillway channel near base

9. Emergency Storage Pond Spillway



9.07: May 10, 2017 Ponded water in stilling basin at end of ESP Emergency Spillway

APPENDIX III

Quantifiable Performance Objectives and 2017 Instrumentation Monitoring

Appendix III

Quantifiable Performance Objectives and 2017 Instrumentation Monitoring

III.1 QUANTIFIABLE PERFORMANCE OBJECTIVES

Quantifiable Performance Objectives (QPOs) have been established for all of the instrumentation and for the freeboard under normal operating conditions for those tailings facilities which have ponds, i.e., ARD Pond and ESP. The QPOs are discussed below.

III.1.1 Piezometric

Pneumatic, standpipe and vibrating wire piezometers are all used at site to monitor phreatic surfaces within the tailings facilities and foundations. The threshold levels established for the piezometers, required monitoring frequency and current readings are summarized in Section III.2 Table AIII.3

The following is required when a threshold level is reached for a single instrument:

- Data, data reductions and calculations are checked for accuracy and correctness.
- If no errors are found in the calculations, the Mine Manager is notified that an anomalous reading has been observed and that further assessment must be conducted. The EOR is notified at this time. The EOR will evaluate data for reliability, review data within the general vicinity of the individual instrument. The EOR may require the following:
 - ♦ Check of readout equipment to verify that it is functioning correctly and to verify calibration.
 - ♦ Re-read instrument and other nearby instruments for confirmation.
 - ♦ Adjust on-going monitoring frequency as required.
- If it is observed that an instrument or piece of readout equipment has stopped functioning, the Mine Manager and subsequently the EOR should be notified immediately. If considered critical, a replacement instrument should be installed.

If several instruments within an area of the dikes or dams are observed to exceed the threshold levels then the following is required:

- The Mine Manager and EOR should be notified within 24 hours.
- Monitoring frequency will be increased as needed based on assessment of common trend.
- EOR to assess the dam integrity and may recommend analyses, site visit or implementation of remedial actions as required.

III.1.2 Settlement

There are several methods used to monitor settlement at the Sullivan Mine tailings facilities. These include settlement plates, Sondex settlement gauges, and surveys.

Threshold levels have been established for the various settlement measurements. These are summarized along with survey results and required monitoring frequency in Section III.2 Table AIII.4.

The following response is required when the threshold level is exceeded at one instrument:

- Notify EoR within 24 hours upon verification of reading exceedance.
- EoR to evaluate data for reliability, and review survey data within the general vicinity of the individual survey monument in question. EoR may recommend repeat measurement and increased on-going monitoring frequency.

If more than one instrument within the facility indicates exceedance of the threshold level then the following is required:

- Notify EoR within 24 hours upon verification of reading exceedance.
- Repeat reading within 1 week.
- EoR to assess dam integrity and may recommend analyses, site visit or other action.

III.1.3 Lateral Movement

There is one inclinometer installed in the East Gypsum Dike to monitor lateral movements. A threshold level has been established for the inclinometer and is provided along with the required monitoring frequency in Section III.2 Table AIII.4.

The following response is required when the threshold level is exceeded:

- Data reductions are checked for accuracy and correctness.
- EoR to evaluate data for reliability, and review other instrumentation in vicinity of the slope inclinometer. Repeat measurement and/or measurement of other instruments may be recommended.
- EoR to assess dam integrity and may recommend analyses, site visit or other action.

III.1.4 Seepage

There are 4 weirs installed to measure seepage from the ARD Pond South Dam and the Iron Dike. Threshold levels have been established and are provided along with the required monitoring frequency in Section III.2 Table AIII.5.

The following response is required when the threshold level is exceeded:

- Data and data reductions are checked for accuracy and correctness.
- EoR to evaluate data for reliability, and review other instrumentation in the vicinity. Repeat measurement and/or measurement of other instruments may be recommended.
- EoR to assess dam integrity and may recommend analyses, site visit or other action.

III.1.5 Freeboard

There are three threshold levels which have been set for the ARD Pond and the ESP, which are provided in Section III.2 Table AIII.6.

Threshold Level 1 indicates when the pumps should be started to transfer water to either the Drainage Water Treatment Plant (ARD Pond) or to the ARD Pond (ESP).

Threshold Level 2 indicates when water levels are approaching maximum operating levels. When Threshold Level 2 is met or exceeded, transfer of water should continue as well as notifying the EOR and minimizing inflows. For the ARD Pond this could include diverting 3700/39000 to ESP and for the ESP stop pumping to ESP and divert runoff if possible.

Threshold Level 3 indicates when water levels are within 0.5 m of the spillway inverts. When Threshold Level 3 is met or exceeded, continue with transfer of water, minimizing inflows, notification of the EOR and notify MEMPR/MOE of potential spill as well as enacting Emergency Preparedness and Response Plan (EPRP).

III.1.6 Visual Inspections

As part of the QPOs, a series of regularly scheduled inspections is required to ensure that the tailings facilities are operating as intended and to identify problems and issues so that necessary corrective actions may be implemented in a timely manner. The main types of inspections are as follows:

- routine inspections (performed by Teck staff);
- event driven inspections (performed by Teck staff, and the Engineer of Record depending on the event);
- annual inspection (performed by the Engineer of Record); and
- dam safety review (performed by an independent and qualified professional engineer).

Routine Visual Inspections

Routine visual inspections are performed by Teck staff and documented using one of the standard inspection forms, which are included in Appendix E of the OMS Manual. Two types of forms are provided: one for Weekly/Bi-weekly inspections and forms for Monthly/Annual inspections.

The minimum visual inspection frequency for each of the structures can be found in Table III.1.

Table III.1: Visual Inspection Requirements for the Dykes and Dams at Sullivan Mine

| Dyke/Pond | | CDA Classification | Pond Elevation | Visual Inspection Requirements |
|-------------------------------------|---------|--------------------|-------------------|---|
| ARD Pond Dykes | | Very High | < 1040 m | Monthly |
| | | | >1040 m | Weekly (a Monthly Inspection form must be filled in once per month if pond is high for an extended period of time, i.e. greater than one month) |
| Iron Dyke (STA 0+00 to 10+00) | | High | N/A | Monthly |
| Iron Dyke (STA 10+00 to end of dam) | | High | N/A* ¹ | Annually |
| Old Iron Pond | SW Limb | Low | N/A* ¹ | Annually |
| | SE Limb | Low | | |
| Siliceous Pond Dykes #1, #2 and #3 | | Low | | Annually |
| Gypsum Pond Dykes | West | High | | Annually |
| | East | High | | |

| | | | |
|--|-----|-----|---|
| Northeast Gypsum Dyke and Recycle Pond | Low | | Annually |
| Calcine Dyke | Low | | Annually |
| Sludge Pond | Low | N/A | Bi-Weekly during DWTP operations otherwise Annually |

*1 Closed facilities no active pond.

The following is a list of general information that should be recorded (monthly and annual inspections):

- signs of depressions and/or movements of the downstream dam/dike slope;
- general condition of the dam/dike crest, toe, and faces, looking for settlement, erosion, seepage, cracking, animal burrows, vegetation growth or other abnormal conditions;
- water levels in active ponds;
- depth of flow in spillways (record zero flow in spillway as 0.0 m³);
- issues related to blockage and inadequate capacity of spillway channels; and,
- seepage noting change in flow rate and visual cloudiness and any new seepage.

Documentation of the routine inspections should be submitted to the Mine Manager following each inspection. If any maintenance requirements or anomalies are identified during the inspection, these must be identified to the mine manager.

The annual routine inspection by Teck staff should be planned such that it does not coincide with the annual inspection performed by the Engineer of Record. The annual routine inspection should include photographs of key features and any potential dam/dike safety concerns.

The completed inspection forms are stored in an electronic data base system, and hard copies of the inspection forms are catalogued and stored at Sullivan Mine.

Event Driven Inspections

In addition to routine inspections, special inspections may be required for significant seismic or climatic events, or anomalous instrumentation readings. Table III.2 presents the specific inspections to be carried out following specified events. All events involve immediate inspection by Teck staff, followed if required by notification to or inspection by the Engineer of Record.

Table III.2: Event Driven Inspections

| Item | Event | Action | Comment |
|---------------------------------|---|--|---|
| Embankments | Earthquake M5 or bigger within 100 km | Immediate inspection by Teck staff | Call the Engineer of Record if damage is noted |
| | | Read all instruments within one week | Send instrument data to the Engineer of Record |
| | Earthquake M6 or bigger within 100 km | Inspection by the Engineer of Record Read all instruments | |
| | Rainfall (50 year event): 6 hour > 40 mm 24 hour > 56 mm Snowpack (50 year event): Accumulated snow water equivalent > 360 mm | Check and record water ponding Check dam toe seepage daily Drawdown water level if necessary | |
| | DWTP water delivery system fails | Check water level in the ARD Pond and ESP daily Check rainfall daily Prepare standby pumps if required | Call the Engineer of Record if one pond is more than 75% full |
| | Instability or noticeable deformation, displacement of riprap. | Inspection by the Engineer of Record | |
| Surface Water Conveyance System | Rainfall (50 year event): 6 hour > 40 mm 24 hour > 56 mm Snowpack (50 year event): Accumulated snow water equivalent > 360 mm | Check and record water flow and ponding Check channels for debris Check channels for damage to riprap lining | |

Annual Inspections

Annual inspections shall be carried out by the Engineer of Record for the tailings facilities for Sullivan Mine. The objective of the annual inspection is to confirm the routine inspections carried out, and to carry out a review of the conditions of the facilities and facility operation. The site water balance is reviewed to confirm the inputs and assumptions are still valid according to the current conditions.

The Engineer of Record issues an annual inspection report to the Mine Manager containing observations and recommendations. This report provides information to be used to revise the operation, maintenance and surveillance programs as necessary and to assist in planning for future operation of the facility. The annual inspection reports are issued to the British Columbia Ministry of Environment (BC MOE) by March 31 each year (as stated in Permit No. 74). Copies of the annual inspection report are to be stored at Sullivan Mine.

III.2 INSTRUMENT DATA SUMMARY

The lists of active instruments and measurement points, along with alarm threshold levels and maximum readings from the 2017 DSI reporting period, are shown in Tables AIII.3, AIII.4, AIII.5, and AIII.6. Updated instrument readings were provided to KCB by Vast Resources (Vast), TM TECH Services and Teck staff on several occasions from October 2016 to August 2017. Daily, then weekly

readings of several selected instruments were taken during the year to better identify potential trends. Vast of Cranbrook, British Columbia is contracted by Teck to read the pneumatic and standpipe piezometers, and TM-TECH Services to survey the settlement plates. The daily/weekly readings for the weirs and ARD Pond standpipes were performed by Teck staff. KCB also selectively read several standpipes during the DSI site visit. Copies of the plots that were produced for each impoundment area are included in Appendix IV through Appendix X.

Table AIII.3 Active Piezometers

| Group Designation | Piezometer No. | Elevation Ground/Tip (m) | General Location | Instrument Type | Recommended Reading Frequency | Threshold Level (m) | Max Measured Piezometer Level In 2017 ¹ (m) | Max 2017 Level Relative To 2016 | Comment | |
|-----------------------|----------------|--------------------------|--------------------|-----------------|--|--|--|---------------------------------|---|---|
| Iron Pond Dike | | | | | | | | | | |
| Line 6+00 | P91 – 1 | 1037.3/1023.0 | Dike | Pneumatic | Three times a year (spring, summer and fall) | 1028.4 | 1024.3 (13 July 2017) | ↑ | | |
| | P91 – 2A | 1029.7/1020.1 | Road | Pneumatic | | 1026.9 | 1024.0 (13 July 2017) | ↑ | | |
| | P91 – 2B | 1029.3/1021.5 | Road | Pneumatic | | 1026.9 | 1023.9 (13 July 2017) | ↑ | | |
| Line 16+00 | SB – P15 | 1033.9/1029.0 | Pond | Pneumatic | | 1036.2 | 1033.5 (13 July 2017) | ↑ | | |
| | P91 – 3A | 1038.4/1008.6 | Dike | Pneumatic | | 1024.8 | 1023.8 (13 July 2017) | ↑ | | |
| | P91 – 3B | 1038.3/1023.7 | Dike | Pneumatic | | 1025.8 | 1023.8 (13 July 2017) | ↔ | | |
| | P91 – 3C | 1038.9/1021.3 | Dike | Pneumatic | | 1025.4 | 1021.4 (05 June 2017) | ↔ | | |
| | P91 – 4 | 1031.5/1017.2 | Bench | Pneumatic | | 1021.4 | 1020.4 (13 July 2017) | ↔ | | |
| Line 16+00 | P92 – 20 | 1033/1010.4 | Bench | Pneumatic | | 1015.9 | 1015.88 (11 April 2017) | ↑ | Near Trigger level. Recent reading lower. | |
| | P92 – 21 | 1033/1012.2 | Bench | Pneumatic | | 1015.9 | 1015.86 (11 April 2017) | ↑ | Near Trigger level. Recent reading lower. | |
| Line 24+00 | P91 – 5A | 1039.7/1017.7 | 2400 Bench at Dike | Pneumatic | Monthly | 1031.8 | 1031.2 (13 July 2017) | ↔ | | |
| | P91 – 5B | 1039.7/1026.7 | 2400 Bench at Dike | Pneumatic | | 1030.0 | 1027.3 (13 July 2017) | ↔ | | |
| | P91 - 6 | 1031.5/1020.5 | 2400 Bench at Dike | Pneumatic | | 1023.6 | 1023.2 (13 July 2017) | ↑ | Near Trigger level (within fluctuation range) | |
| Line 30+00 | P92 – 1 | 1035.1/1021.1 | 91 Dike | Pneumatic | | 1033.0 | 1032.1 (11 April 2017) | ↑ | | |
| | P92 – 2 | 1028.6/1024.0 | Slope | Pneumatic | | 1027.8 | 1026.8 (09 Feb 2017) | ↑ | Near Trigger level (within fluctuation range). Recent reading lower | |
| Line 34+00 | P91 – 13 | 1029.7/1020.0 | Toe | Pneumatic | | Three times a year (spring, summer and fall) | 1022.9 | 1022.7 (13 July 2017) | ↑ | Near Trigger level (within fluctuation range) |

Notes: 1. Water levels are considered equal if differences are smaller than 0.1 m., 2. 2017 reporting period runs from October 1, 2016 to August 31, 2017.

Table AIII.3 Active Piezometers (continued)

| Group Designation | Piezometer No. | Elevation Ground/Tip (m) | General Location | Instrument Type | Recommended Reading Frequency | Threshold Level | Max Measured Piezometer Level In 2017 ¹ | Max 2017 Level Relative To 2016 | Comment |
|------------------------------|----------------|--------------------------|------------------|-----------------|---|--------------------------|--|---------------------------------|---|
| Iron Pond Dike Cont'd | | | | | | | | | |
| Line 38+00 | P92 – 6 | 1042.1/1024.2 | 91 Dike | Pneumatic | Three times a year (spring, summer and fall) | 1033.6 | 1032.8 (11 April 2017) | ↑ | |
| | P92 – 7 | 1040.2/1029.6 | Slope | Pneumatic | | 1032.7 | 1031.3 (11 April 2017) | ↑ | |
| | P92 – 9 | 1029.9/1025.3 | Toe | Pneumatic | | 1028.4 | 1028.0 (05 June 2017) | ↑ | Near Trigger level (within fluctuation range) Recent reading lower |
| Line 42+00 | P92 – 11 | 1031.5/1025.0 | Toe | Pneumatic | | 1028.4 | 1027.2 (11 April 2017) | ↑ | |
| | P91 – 11A | 1042.4/1027.0 | 91 Dike | Pneumatic | | 1036.7 | 1034.2 (13 July 2017) | ↑ | |
| | P91 – 11B | 1042.3/1029.9 | 91 Dike | Pneumatic | | 1036.7 | 1034.0 (13 July 2017) | ↑ | |
| | P91 – 12 | 1040.9/1029.7 | Slope | Pneumatic | | 1034.5 | 1033.5 (13 July 2017) | ↑ | |
| | P92 - 16 | 1037.3/1027.6 | Slope | Pneumatic | | 1030.6 | 1029.8 (11 April 2017) | ↓ | |
| Line 45+00 | P92 - 13 | 1040.5/1031.3 | 91 Dike | Pneumatic | | 1037.3 | 1034.6 (13 July 2017) | ↑ | |
| | P92 - 14 | 1037.4/1029.6 | Slope | Pneumatic | | 1036.8 | 1031.8 (11 April 2017) | ↓ | |
| | P92 - 15 | 1030.3/1029.0 | Toe | Pneumatic | 1030.3 | 1029.1 (05 June 2017) | ↓ | | |
| Toe Piezometers | P92 – H | 1025.55/998.2 | 21+00 | Standpipe | Weekly | 1032.0 | 1025.5 (22 April 2017) | ↑ | Pressure gauge no longer read, VWP with data logger installed in standpipe. |
| | P92 – 25 | 1022.9/999.0 | 28+00 | Pneumatic | Monthly | 1032.0 | 1029.8 (05 June 2017) | ↑ | |
| | P92 – 26 | 1020.4/1009.0 | 16+00 | Standpipe | Three times a year (spring, summer and fall) | 1015.0 | 1014.5 (11 April 2017) | ↑ | |

Notes: 1. Water levels are considered equal if differences are smaller than 0.1 m., 2. 2017 reporting period runs from October 1, 2016 to August 31, 2017

Table AIII.3 Active Piezometers (continued)

| Group Designation | Piezometer No. | Elevation Ground/Tip (m) | General Location | Instrument Type | Recommended Reading Frequency | Threshold Level | Max Measured Piezometer Level In 2017 ¹ | Max 2017 Level Relative To 2016 | Comment | |
|---------------------------|---------------------|--------------------------|-------------------------|----------------------|--|------------------|--|---------------------------------|--|--|
| Old Iron Pond Dike | | | | | | | | | | |
| Southwest Limb | P93 – 17 | 1043.0/1025.8 | Dike | Standpipe | Three times a year (spring, summer and fall) | 1037.3 | 1037.7 (11 April 2017) | ↑ | Max. 2017 reading above trigger level. Recent reading is below trigger level | |
| | P93 – 18 | 1044.4/1028.3 | Dike | Standpipe | | 1039.0 | 1039.1 (11 April 2017) | ↑ | Max. 2017 reading above trigger level. Recent reading is below trigger level. | |
| | P96 – 08 | Not available | MCE Buttress | Pneumatic | | 2.6 ² | 3.54 m (11 April 2017) | ↑ | Max. 2017 reading above trigger level. Recent reading is lower but still above. | |
| | P96 – 02 | Not available | MCE Buttress | Pneumatic | | -3.6 | | | | Destroyed. |
| | P96 – 11 | Not available | MCE Buttress | Pneumatic | | -1.5 | | | | Slow leak, erratic data, to be replaced. |
| | P96 – 12 | Not available | MCE Buttress | Pneumatic | | 0.9 ² | 0.49 m (11 April 2017) | ↑ | | |
| Southeast Limb | P93 – 19 | 1042.6/1025.6 | Dike | Standpipe | Annual | 1040.15 | 1039.8 (13 July 2017) | ↑ | Dike is fully buttressed. P93-19 (near trigger level) and P93-20 are read to provide U/S info for SW Limb. | |
| | P93 – 20 | 1044.3/1026.4 | Dike | Standpipe | | 1041.25 | 1040.8 (13 July 2017) | ↑ | | |

Notes:

1. Water levels are considered equal if differences are smaller than 0.1 m., 2. 2017 reporting period runs from October 1, 2016 to August 31, 2017.
2. Installation elevation not known.

Table AIII.3 Active Piezometers (continued)

| Group Designation | Piezometer No. | Elevation Ground/Tip (m) | General Location | Instrument Type | Recommended Reading Frequency | Threshold Level | Max Measured Piezometer Level In 2017 ¹ | Max 2017 Level Relative To 2016 | Comment |
|--|----------------|--------------------------|------------------|-----------------|--|-----------------|--|---------------------------------|---|
| Siliceous Pond Dikes | | | | | | | | | |
| West Side Siliceous Pond Dike #1 | P5 | 1039.1/1037.4 | Pond #1 | Standpipe | P105 and P5 annually unless change >0.5 m or at trigger levels then read all Piezometers | 1039.1 | 1039.0 (13 July 2017) | ↑ | Near Trigger level (increase < 0.5) |
| | SP101 | 1035.4/1021.6 | Pond #1 | Standpipe | | 1023.9 | 1021.7 (13 July 2017) | ↔ | |
| Middle Siliceous Pond Dike #1 | P105 | 1033/1021.3 | Pond #1 | Standpipe | | 1022.0 | 1022.16 (13 July 2017) | ↑ | Max. 2017 reading above trigger level (increase < 0.5) |
| | SP104 | 1035.4/1021.1 | Pond #1 | Standpipe | | 1022.0 | 1021.22 (13 July 2017) | ↑ | |
| East Side Siliceous Pond Dike #1 | SP106 | 1035.1/1020.9 | Pond #1 | Standpipe | | 1021.4 | 1021.2 (13 July 2017) | ↑ | Near Trigger level |
| Crest Siliceous Pond Dike #2 | P231 | 1028.4/1019.5 | Pond #2 | Standpipe | Annual | 1022.3 | 1021.1 (13 July 2017) | ↑ | |
| | P257 | 1030/1022.0 | Pond #2 | Standpipe | | 1025.4 | 1023.2 (13 July 2017) | ↑ | |
| Lines 3+00/7+00 Siliceous Pond Dike #3 | P303 | 1029/1020.9 | 7+00 Crest | Standpipe | P232, P301 and P303 annually unless change >0.5 m then read all Piezometers | 1022.3 | 1020.9 (13 July 2017) | ↔ | Dry |
| | P301 | 1028.1/1020.6 | 3+00 Crest | Standpipe | | 1022.3 | 1022.6 (13 July 2017) | ↑ | Max. 2017 reading above trigger level (increase > 0.5) |
| | P302 | 1025.7/1021.0 | 3+00 Slope | Standpipe | | 1021.2 | 1021.0 (13 July 2017) | ↔ | Dry |
| | P232 | 1026.7/1017.4 | 7+00 Slope | Standpipe | | 1019.3 | 1018.0 (13 July 2017) | ↔ | |
| | P233 | 1023.6/1017.9 | 7+00 Slope | Standpipe | | 1019.3 | 1017.9 (13 July 2017) | ↔ | |

Notes:

1. No settlement plate or other instruments are required for long term monitoring of the Siliceous pond dikes.
2. Water levels are considered equal if differences are smaller than 0.1 m.
3. 2017 reporting period runs from October 1, 2016 to August 31, 2017

Table AIII.3 Active Piezometers (continued)

| Group Designation | Piezometer No. | Elevation Ground/Tip (m) | General Location | Instrument Type | Recommended Reading Frequency | Threshold Level | Max Measured Piezometer Level In 2017 ¹ | Max 2017 Level Relative To 2016 | Comment |
|--------------------------------|--------------------|--------------------------|---------------------|----------------------|--|-------------------|--|---------------------------------|--------------------------------|
| Gypsum Pond Dikes | | | | | | | | | |
| W. Gypsum Pond Dike Line 10+00 | P93 – 1 | 1013.8/998.9 | Upstream | Standpipe | Three times a year (spring, summer and fall) | 1008.0 | 1004.7 (13 July 2017) | ↑ | |
| | P93 – 2 | 1014.4/996.8 | Upstream | Standpipe | | 1008.0 | 1004.6 (13 July 2017) | ↑ | |
| | P93 – 3 | 1017.5/998.0 | Crest | Standpipe | | 1008.0 | 1004.5 (13 July 2017) | ↑ | |
| | P93 – 4 | 1017.5/995.4 | Crest | Standpipe | | 1008.0 | 1004.4 (13 July 2017) | ↑ | |
| | P93 – 5 | 1011.1/993.3 | Downstream | Standpipe | | 1008.0 | 995.3 (13 July 2017) | ↑ | |
| W. Gypsum Pond Dike Line 20+00 | P93 – 6 | 1014.4/997.9 | Upstream | Standpipe | Three times a year (spring, summer and fall) | 1008.0 | - | - | Standpipe blocked at ~ 10.4 m |
| | P93 – 7 | 1015.3/997.2 | Crest | Standpipe | | 1008.0 | 997.2 (13 July 2017) | ↔ | Dry |
| E. Gypsum Pond Dike Line 33+00 | P93 – 8 | 1017.2/1001.9 | Upstream | Standpipe | Annual | 1010.1 | 1009.0 (13 July 2017) | ↑ | |
| | P93 – 9 | 1017.2/998.6 | Upstream | Standpipe | | 1010.1 | 1009.2 (13 July 2017) | ↑ | |
| | P93 – 10 | 1017.5/1002.6 | Crest | Standpipe | | 1009.5 | 1008.0 (13 July 2017) | ↑ | |
| | P93 – 11 | 1017.5/998.7 | Crest | Standpipe | | 1008.6 | 1007.2 (07 Nov 2016) | ↔ | No reading available for 2017. |
| | P93 – 12 | 1013.5/1000.8 | Toe | Standpipe | | 1004.7 | 1004.2 (13 July 2017) | ↑ | |
| E. Gypsum Pond Dike Line 48+00 | P93 – 13 | 1016.8/1000.3 | Upstream | Standpipe | Annual | 1002.5 | 1000.7 (13 July 2017) | ↑ | |
| | P93 – 14 | 1017.2/1004.3 | Crest | Standpipe | | 1005.6 | 1004.30 (13 July 2017) | ↔ | Dry |

Notes:

1. Water levels are considered equal if differences are smaller than 0.1 m.
2. 2017 reporting period runs from October 1, 2016 to August 31, 2017

Table AIII.3 Active Piezometers (continued)

| Group Designation | Piezometer No. | Elevation Ground/Tip (m) | General Location | Instrument Type | Recommended Reading Frequency | Threshold Level | Max Measured Piezometer Level In 2017 ¹ | Max 2017 Level Relative To 2016 | Comment |
|-------------------------|----------------|--------------------------|------------------|-----------------|--|----------------------------|--|--|--|
| ARD Storage Pond | | | | | | | | | |
| North Dam | PP01-01 | Tip 1041.7 | North Dam | Pneumatic | Three times a year (spring, summer and fall), with additional readings taken weekly when the Pond level is above 1040 masl, or daily when the Pond level is above 1045 masl. | 1042.7 | 1041.72 (13 July 2017) | ↓ | |
| | PP01-02 | Tip 1041.9 | North Dam | Pneumatic | | 1042.9 | 1042.31 (11 April 2017) | ↑ | |
| | PP01-03 | Tip 1038.8 | North Dam | Pneumatic | | 1039.8 | 1038.82 (13 July 2017) | ↓ | |
| | PP01-04 | Tip 1040.8 | North Dam | Pneumatic | | 1041.8 | 1040.95 (05 June 2017) | ↑ | |
| | ND-01 | 1042.3/1032.0 | North Abutment | Standpipe | | 1042.2 | 1041.00 (25 Nov 2016) | ↑ | Recent readings are lower |
| | ND-02D | 1042.2/1019.5 | Toe | Standpipe | | 1041.5 | 1039.95 (18 April 2017) | ↑ | Recent readings are lower |
| | ND-02S | 1042.2/1040.3 | Toe | Standpipe | | 1041.5 | 1041.63 (16 Mar 2017) | ↑ | Max. 2017 reading above trigger level. Recent readings lower than trigger. |
| | ND-03 | 1038.4/1025.1 | Toe | Standpipe | | 1039.2 | 1038.85 (14 April 2017) | ↑ | Recent readings are lower |
| South Dam | PP01-05 | Tip 1030.0 | South Dam | Pneumatic | | 1031.0 | 1030.60 (11 April 2017) | ↔ | |
| | PP01-06 | Tip 1029.2 | South Dam | Pneumatic | | 1030.5 | 1030.74 (11 April 2017) | ↔ | Max. 2017 reading above trigger level. Recent readings lower than trigger. |
| | SD-01 | 1041.0/1029.6 | South Abutment | Standpipe | 1041.0 | 1035.60 (04 April 2017) | ↑ | | |
| | SD-02 | 1029.9/1026.9 | Toe | Standpipe | 1029.9 | 1029.9 (12 April 2017) | ↑ | Max. 2017 reading at trigger level. Recent readings lower than trigger. | |
| | SD-03 | 1037.0/1036.0 | South Abutment | Standpipe | 1037.0 | 1037.1 (16 Mar 2017) | ↑ | Max. 2017 reading above trigger level. Recent readings lower than trigger. | |

Notes:

1. Water levels are considered equal if differences are smaller than 0.1 m.
2. 2017 reporting period runs from October 1, 2016 to August 31, 2017.

Table AIII.4 Active Settlement and Inclinometer Measuring Instruments

| Type | Instrument Number | Initial Elevation (m) | Location | Threshold Level | Recommended Reading Frequency | Measured Level in 2017 (m) | Comment |
|---|-------------------------|-----------------------|-------------------------------|---|-------------------------------|----------------------------|---|
| Iron Pond Dike | | | | | | | |
| Settlement plates | SP330 ¹ | 1037.40 | 2+00 | >25 mm over 3 years | Every 3 Years | 1040.636 | Less than 40 mm of settlement since 2007 |
| | SP331 ¹ | 1042.44 | 9+00 | | | 1041.386 | Less than 65 mm of settlement since 2007 |
| | SP332 ² | 1041.79 | 9+00 | | | 1041.942 | Less than 45 mm of settlement since 2007 |
| | SP 92 – 07 | 1034.91 | 16+00 | | | 1034.848 | Less than 35 mm of settlement since 2007 |
| | SP 99 – 01 ³ | 1042.07 | 4+00 | | | 1041.103 | Less than 45 mm of settlement since 2007 |
| Inclinometer | BI91 – 02 | | | N/A | Inactive | N/A | Casing damaged. Do not replace unless indications of dike movement observed. |
| Gypsum Pond Dikes | | | | | | | |
| Settlement plates at West Gypsum Dike | SP97 – 01 | 1014.592 | Line 10+00 Slope | >60 mm over 3 years | Annually | 1014.317 | Settled 7 mm since 2016 |
| | SP97 – 05 | 1015.568 | Line 10+00 Crest | | | 1014.622 | Settled 37 mm since 2016 |
| | SP97 – 06 | 1015.936 | Line 20+00 Slope | | | 1015.361 | Settled 19 mm since 2016 |
| Sondex gauge and Inclinometer at West Gypsum Dike | S94 – 01 | N/A | Line10+00 Upstream | >90 mm over 3 years | Every 3 Years | 1.577 | Reading taken in 2016. Cumulative change since 1994 of 1.577, incremental change since 2012 of 0.12. Next reading scheduled for 2019. |
| | BI94-01 | N/A | Line10+00 Upstream | N/A | Inactive | N/A | Inclinometer blocked since 2006 (last read in 2004). Do not replace unless other instruments indicate signs of movement. |
| Settlement plates at East Gypsum Dike | SP97 – 03 | 1017.676 | Line 33+00 | >60 mm over 3 years | Annually | 1017.077 | Settled 23 mm since 2016 |
| | SP97 – 04 | 1017.457 | Line 48+00 | | Annually | 1016.952 | Settled 16 mm since 2016 |
| Sondex gauge and Inclinometer at East Gypsum Dike | S94 – 02 | N/A | Line 33+00 Upstream | >60 mm over 3 years | Every 3 Years | 0.937 | Reading taken in 2016. Cumulative change since 1994 of 0.937, incremental change since 2012 of 0.08. Next reading scheduled for 2019. |
| | BI94 – 02 | N/A | Line 33+00 Upstream | >25 mm horizontal movement over 3 years | Every 3 Years | N/A | <5 mm movement parallel to dike and no change perpendicular to dike. |
| Settlement plates at N.E. Gypsum Dike | SW (S1) | 1019.264 | Main Dike | >5 mm over 3 years | Every 3 Years | 1019.271 | Less than 2 mm of settlement since 2007 |
| | SE (S2) | 1019.073 | Main Dike | | Every 3 Years | 1019.092 | Essentially 0 mm of settlement since 2007 |
| ARD Storage Pond | | | | | | | |
| Settlement Plates | SP01-01 | 1048.009 | North Dam | >25 mm over 3 years | Every 3 Years | 1048.002 | Less than 7 mm of settlement since 2001 |
| | SP01-02 | 1048.224 | North Dam | | | 1048.209 | Less than 15 mm of settlement since 2001 |
| | SP01-03 | 1048.113 | North Dam | | | 1048.094 | Less than 19 mm of settlement since 2001 |
| | SP01-04 | 1048.311 | South Dam | | | 1048.303 | Less than 8 mm of settlement since 2001 |
| | SP01-05 | 1048.310 | South Dam | | | 1048.317 | Essentially 0 mm of settlement since 2001 |
| | SP01-06 | 1048.351 | South Dam | | | 1048.342 | Less than 9 mm of settlement since 2001 |

Notes: (1) SP330 and 331 lowered in 2006. (2) SP332 raised in 2004. (3) SP99-01 lowered in 2006.

Table AIII.5 Active Seepage Measurements October 1, 2016 – August 31, 2017

| Structure/ Weir | Min. Current Reading Frequency | Threshold Level | Weir Readings and Observations – October 1, 2016 to August 31, 2017 | | | | | | | | | | | | | | | | | | | | | | | |
|--|--|----------------------------|---|---------------------|---------------------|---------------------|---------------------|---------------------|---------------------|---------------------|---------------------|---------------------|---------------------|---------------------|---------------------|---------------------|---------------------|---------------------|---------------------|---------------------|---------------------|---------------------|---------------------|---------------------|---------------------|--|
| | | | October | | November | | December | | January | | February | | March | | April | | May | | June | | July | | August | | | |
| | | | Min. flow | Max. flow | Min. flow | Max. flow | Min. flow | Max. flow | Min. flow | Max. flow | Min. flow | Max. flow | Min. flow | Max. flow | Min. flow | Max. flow | Min. flow | Max. flow | Min. flow | Max. flow | Min. flow | Max. flow | Min. flow | Max. flow | | |
| | | | m ³ /day | m ³ /day | m ³ /day | m ³ /day | m ³ /day | m ³ /day | m ³ /day | m ³ /day | m ³ /day | m ³ /day | m ³ /day | m ³ /day | m ³ /day | m ³ /day | m ³ /day | m ³ /day | m ³ /day | m ³ /day | m ³ /day | m ³ /day | m ³ /day | m ³ /day | m ³ /day | |
| ARD Pond/Weir #1 (ARDWU) | Monthly with weekly readings when the pond level is above 1040 m and daily readings when the pond levels are above 1045 m | 150 m ³ /day | Dry | 23.1 | Dry | Dry | Frozen | 36.4 | Frozen | Frozen | Frozen | 53.3 | 36.4 | 202.0 | 53.3 | 128.8 | 13.3 | 53.3 | Dry | 36.4 | Dry | Dry | Dry | Dry | | |
| ARD Pond/Weir #2 | | 175 m ³ /day | Dry | 52.8 | 6.6 | 17.9 | Frozen | 13.4 | Frozen | 13.4 | Frozen | Frozen | Dry | 126.8 | 36.2 | 241.2 | 13.4 | 73.3 | Dry | 17.9 | Dry | Dry | Dry | Dry | | |
| AIP ¹ Dike/Weir #3 (AIPWU) | Monthly | 50 m ³ /day | 2.3 | 6.3 | 2.3 | 6.3 | Frozen | 6.3 | Frozen | 6.3 | Frozen | 6.3 | 0.1 | 51.7 | 2.3 | 61.3 | 2.3 | 35.3 | 2.3 | 12.9 | 2.3 | 12.9 | 2.3 | 12.9 | | |
| AIP ¹ Dike/Weir #4 | | 500 m ³ /day | 0.5 | 53.1 | 6.9 | 44.4 | Frozen | 36.6 | 0 | N/A ² | 0 | 23.5 | 1.30 | 460.5 | 196.1 | 688.5 | 62.7 | 285.7 | 13.7 | 73.3 | 2.6 | 36.6 | 0.9 | 27.1 | | |
| West Gypsum Pond/Toe of Gravel Buttress at Cow Creek (STA. 11+00) | Visual Reading Annually | Cloudy flow | Flow is clear (observed as part of May 2017 site visit) | | | | | | | | | | | | | | | | | | | | | | | |
| East Gypsum Pond/Toe of Dike Adjacent to James Creek | Visual Reading Annually | Cloudy flow | Flow is clear (observed as part of May 2017 site visit) | | | | | | | | | | | | | | | | | | | | | | | |

Note:

1. AIP = Iron Pond
2. N/A – Flow could not be measured as it was by-passing weir.

Table AIII.6 Active Pond Water Level Monitoring Locations

| Type | Description | Location | Primary Purpose | Reading Frequency | Threshold Level 1 | Threshold Level 2 | Threshold Level 3 | General Water Level Information (m) |
|------------------------------------|---|--|-----------------|-------------------|---------------------------|---|--|---------------------------------------|
| Emergency Storage Pond Water Level | Electronic readout unit. | Iron Dike Pump Station | Overtopping | Daily | 1038.5 (Pump to ARD Pond) | 1038.9 (As for Level 1 and notify EOR, minimize inflows, consider pumping to DWTP) | 1040.5 (As for Level 2 and notify MEMPR/MOE, enact EPRP) | 1036.5 (Measured low water) |
| | | | | | | | | 1038.8 (Measured high water) |
| | | | | | | | | 1041.0 ¹ (Spillway invert) |
| | | | | | | | | 1042.0 (Top of dike) |
| Pond Water Level | Electronic readout unit with pressure transducer in bottom of wet well at el. 1034 m. | Pump wet well, data transmitted to DWT control room through the PLC system | Dam Stability | Daily | 1045.5 (Pump to DWTP) | 1046.5 (As for Level 1 and notify EOR, minimize inflows (e.g. divert 3700/3900 to ESP)) | 1046.9 (As for Level 2 and notify MEMPR/MOE, enact EPRP) | 1034.7 (Measured low water) |
| | | | | | | | | 1044.6 (Measured high water) |
| | | | | | | | | 1046.5 9 Maximum operating level) |
| | | | | | | | | 1047.4 (Spillway invert) |
| | | | | | | | | 1048.0 (Top of dam) |

Notes:

1. The surveyed as-constructed invert elevations for the Emergency Storage Pond spillway varied from 1040.8 m to 1041.4 m, with the design elevation being 1041.0 m.

Precipitation Data Summary 2008 - 2017

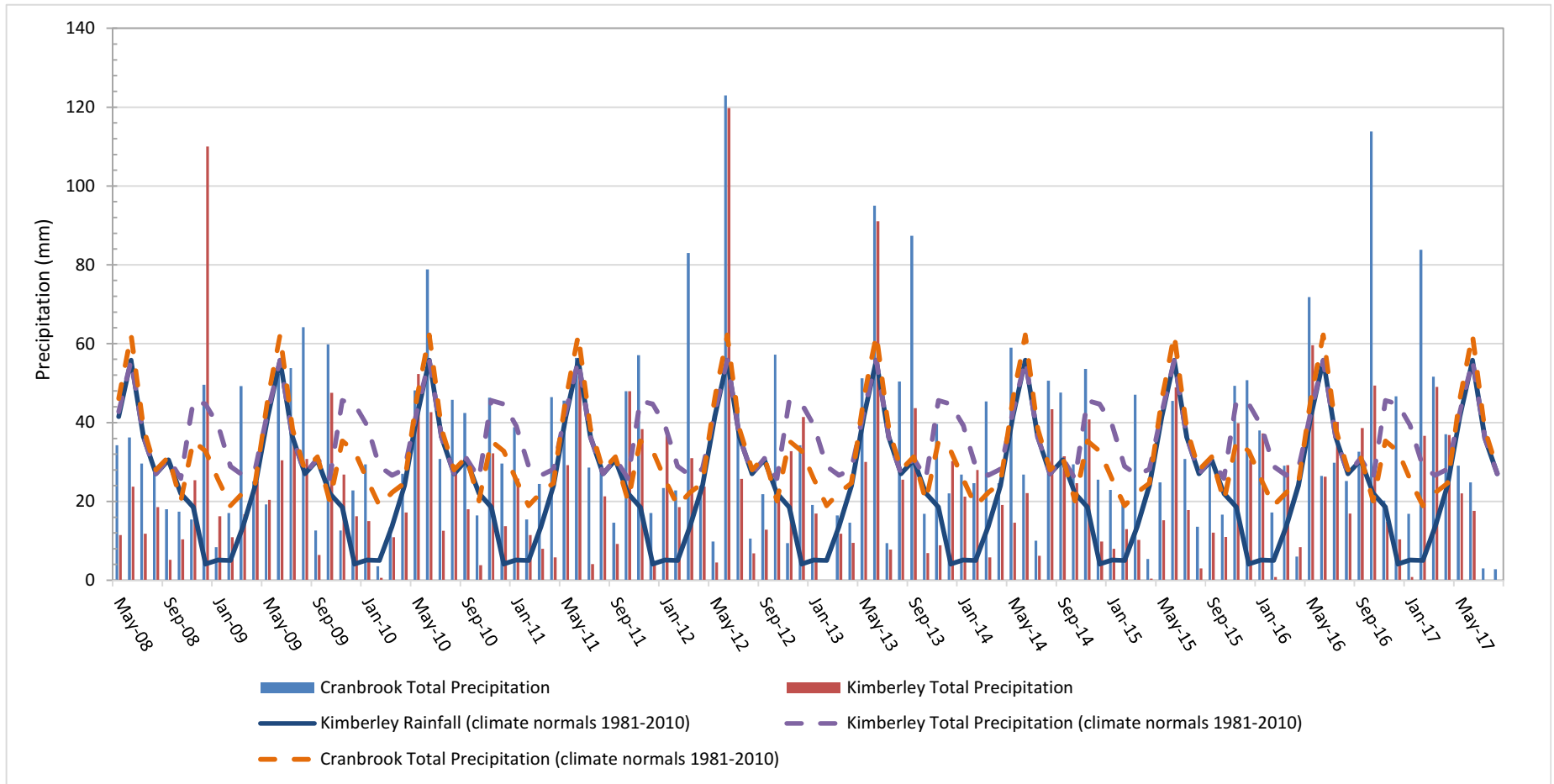

Figure AIII-1

APPENDIX IV

Iron Dike (Emergency Storage Pond) Instrumentation Data

Line 6+00 Piezometer Readings

Iron Dike (Emergency Storage Pond)

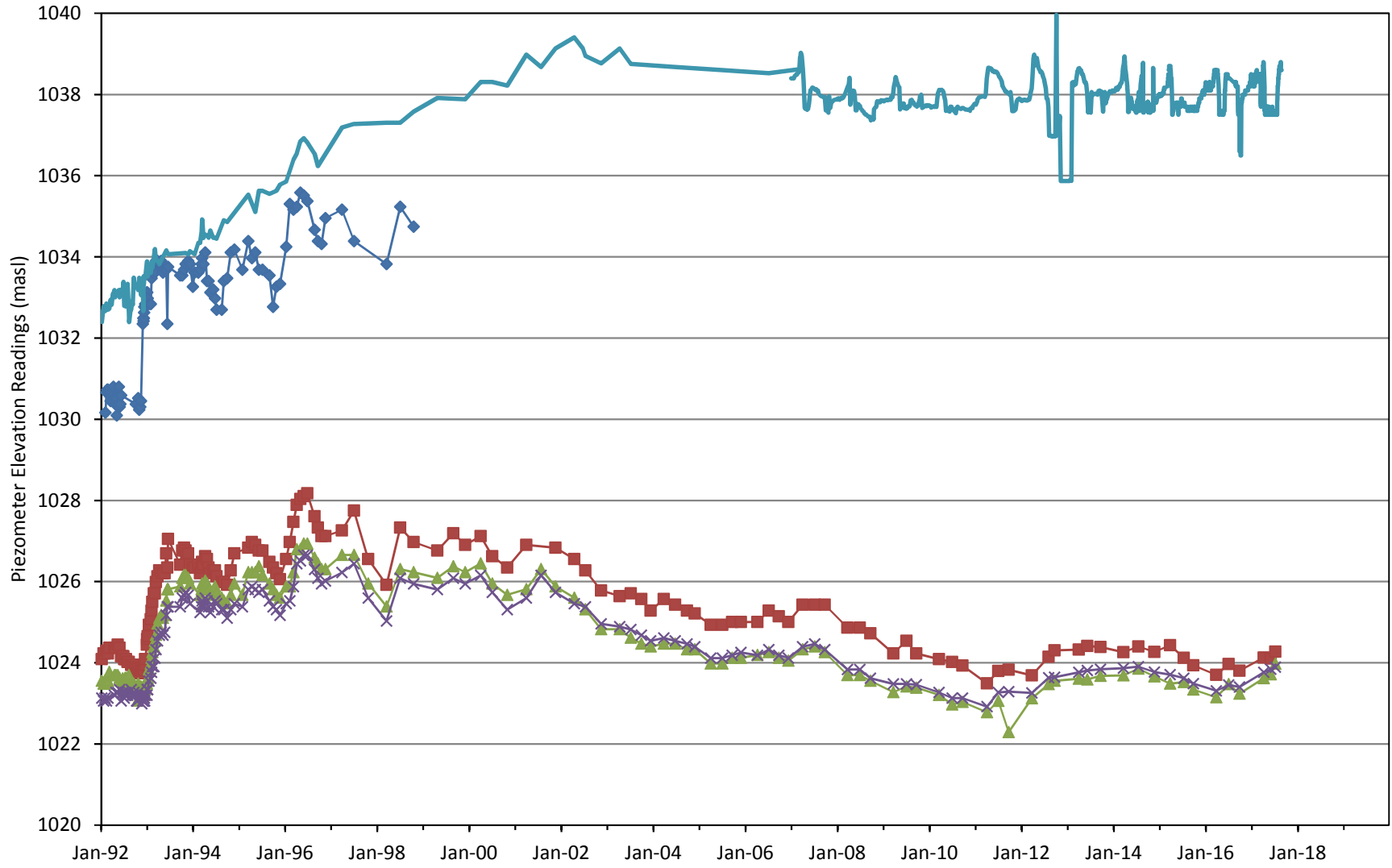

Legend = Piezo #, Ground Elev / Tip Elev, Location

- ◆ SB-P5 1032.7/1029.0 Pond
- ▲ P91-2A 1029.7/1020.5 Road
- ◆ Pond Elevation
- P91-1 1037.2/1023.0 Dyke
- × P91-2B 1029.3/1021.5 Road

Figure IV-1 STN 6 00

Line 16+00 Piezometer Readings

Iron Dike (Emergency Storage Pond)

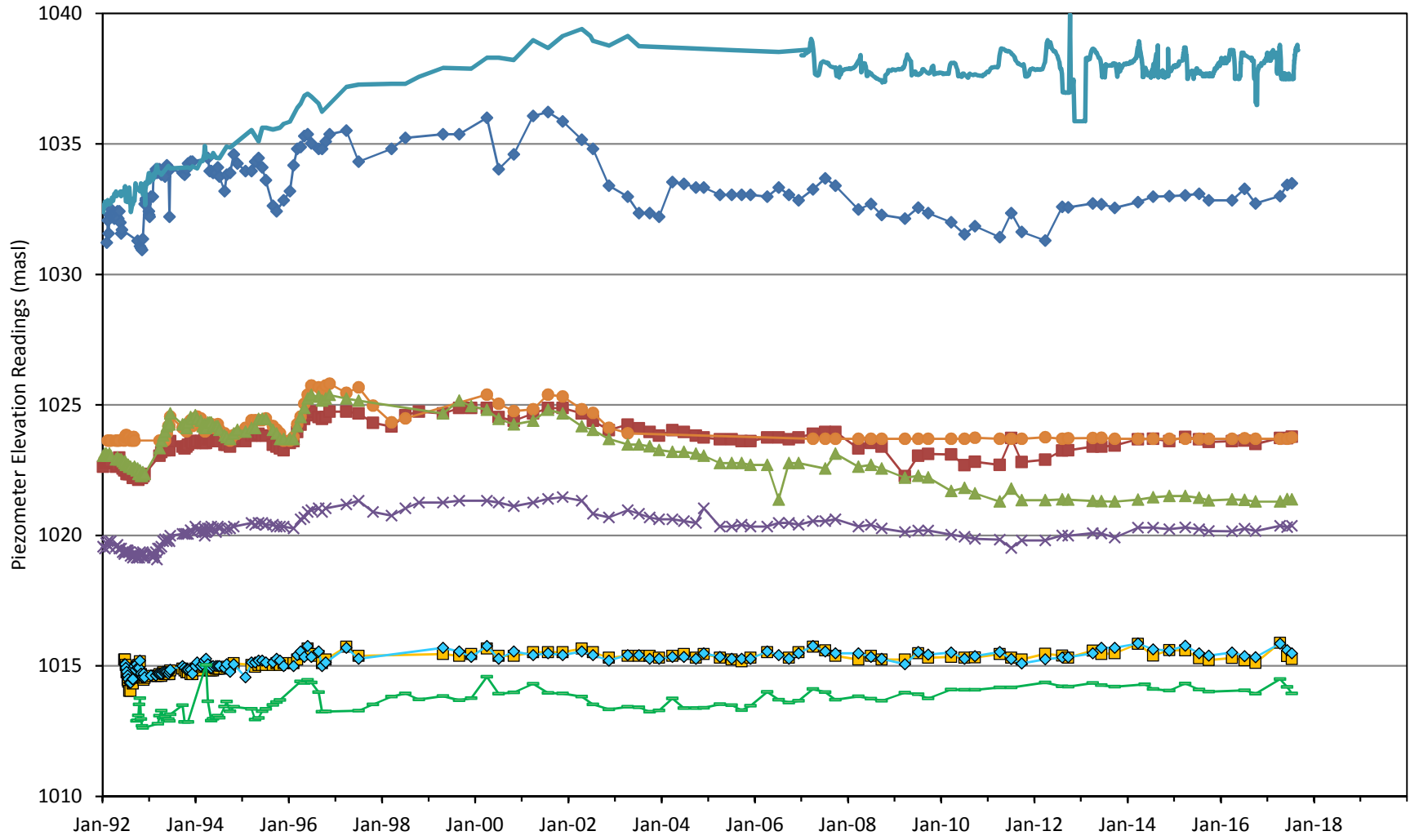

Legend = Piezo #, Ground Elev / Tip Elev, Location

- P91-3A 1038.4/1008.6 Dyke
 ● P91-3B 1038.3/1023.7 Dyke
 ■ P92-20 1033/1010.4 Bench
- ◆ P92-21 1033/1012.2 Bench
 — P92-26 15.0/1009.0 Toe
 ◆ SB-P15 1033.9/1029.0 Pond
- ▲ P91-3C 1038.9/1021.3 Dyke
 × P91-4 1031.5/1017.2 Bench
 — Pond Elevation

Figure IV-2 STN 16 00

Line 24+00 Piezometer Readings

Iron Dike (Emergency Storage Pond)

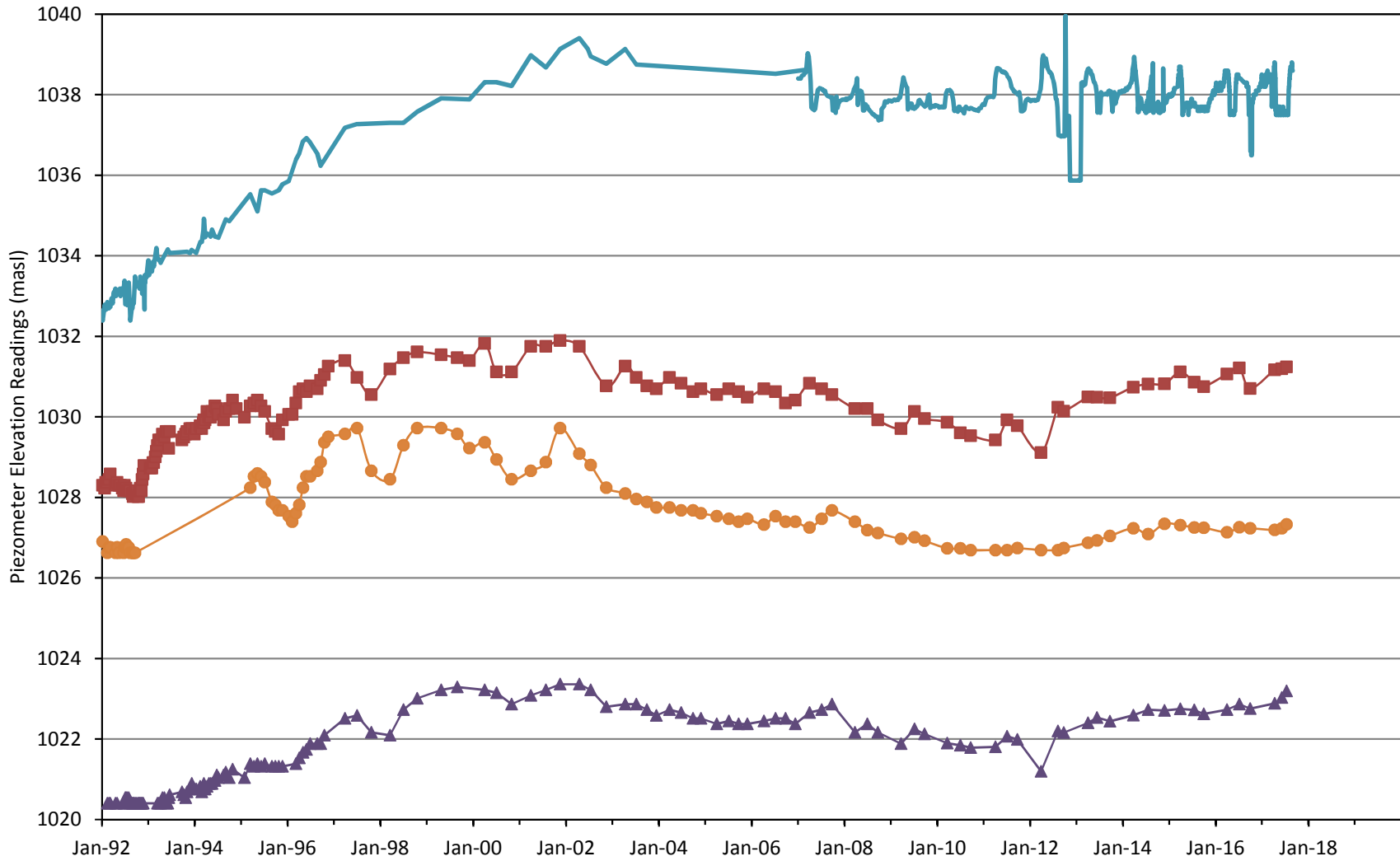

Legend = Piezo #, Ground Elev / Tip Elev, Location

- ▲ P91-6 1031.5/1020.5 Bench
- Pond Elevation
- P91-5A 1039.7/1017.7 Dyke
- P91-5B 1039.7/1026.7 Dyke

Line 30+00 Piezometer Readings

Iron Dike (Emergency Storage Pond)

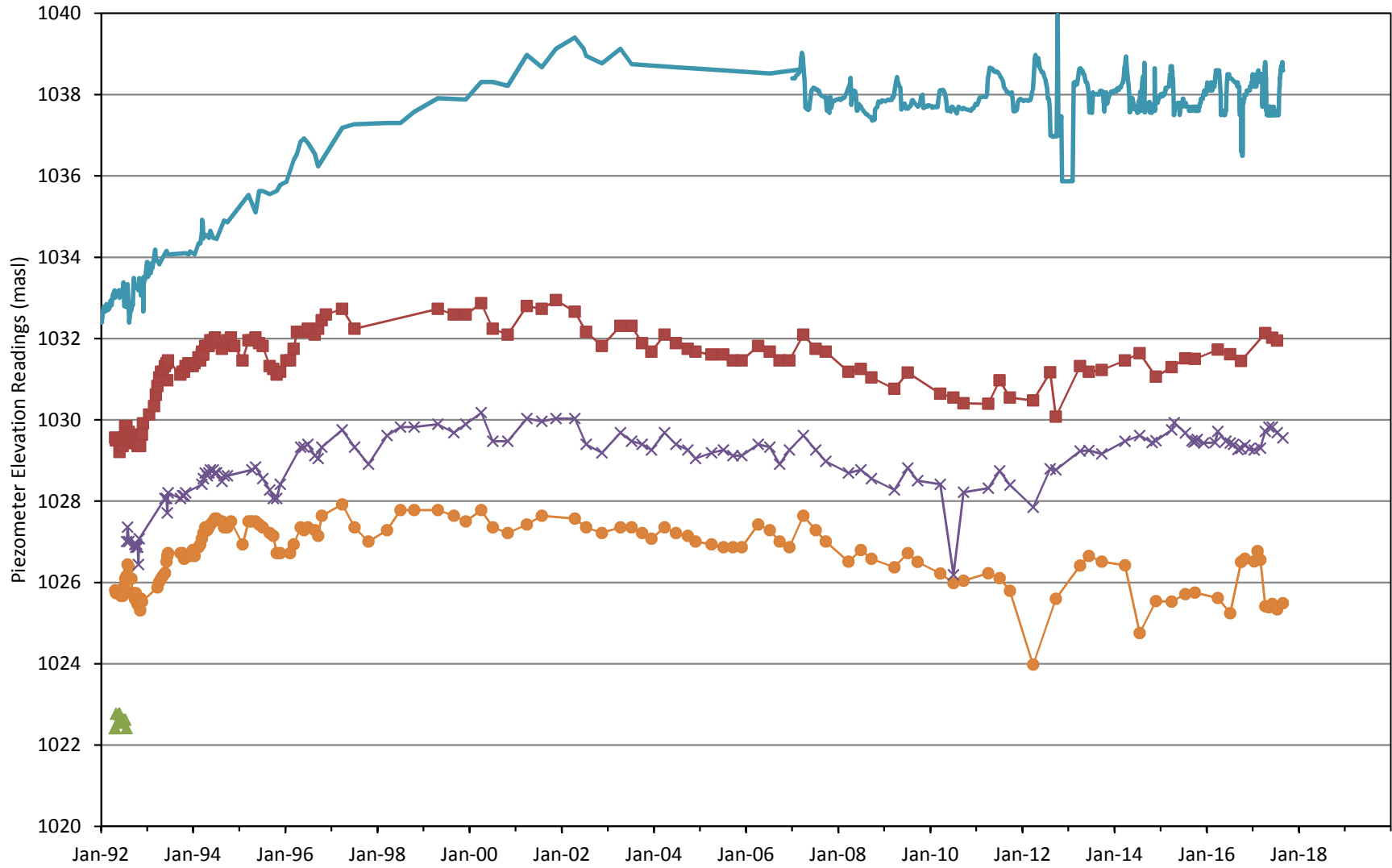

Legend = Piezo #, Ground Elev / Tip Elev, Location

- P92-01 1035.1/1021.1 Dyke
- ▲ P92-03 1026.8/1022.5 Slope
- P92-02 1028.6/1024.0 Slope
- Pond Elevation
- × P92-25 1022.9/999.0 Toe on line 2800

Figure IV-4 STN 30 00

Line 34+00 Piezometer Readings

Iron Dike (Emergency Storage Pond)

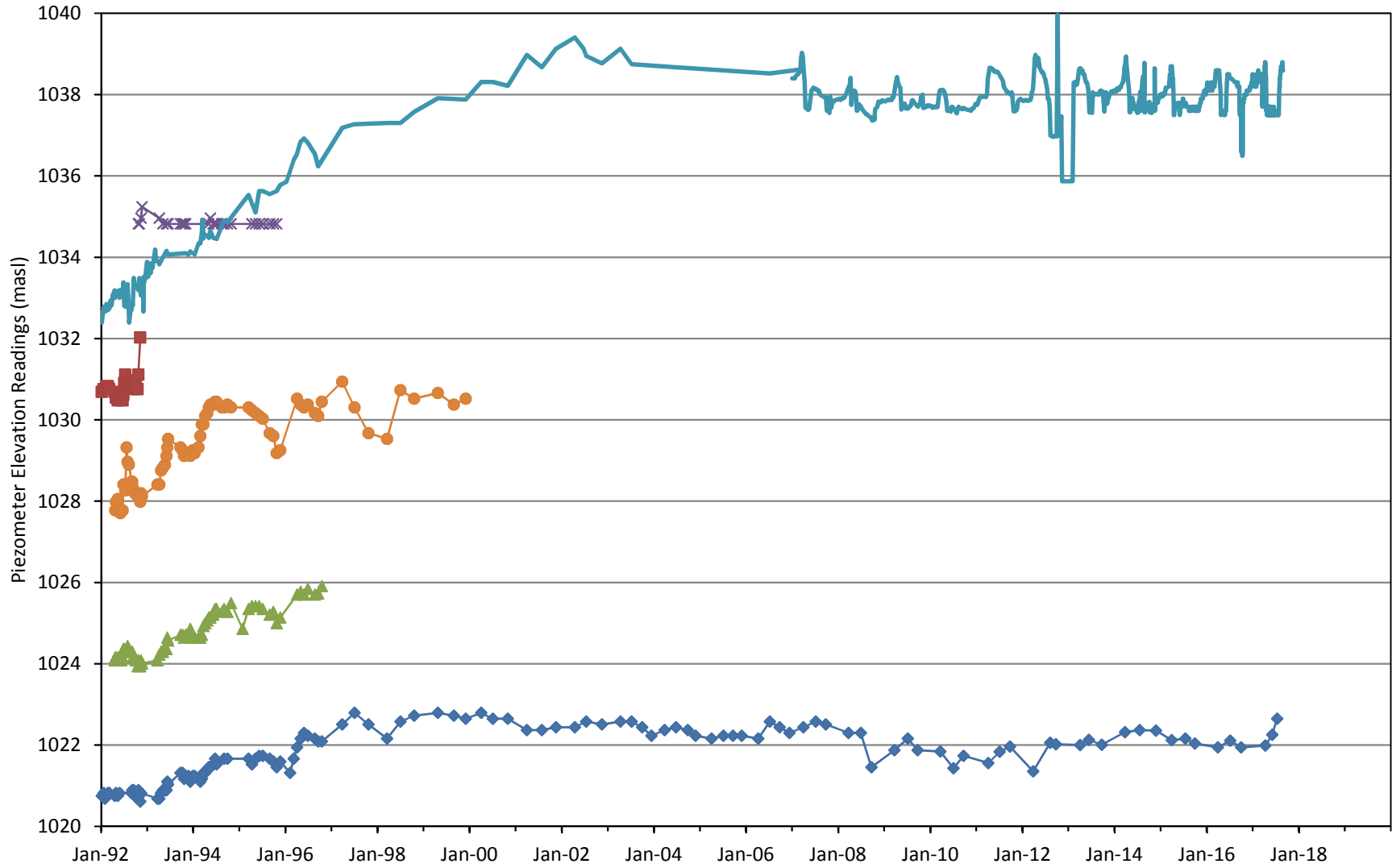

Legend = Piezo #, Ground Elev / Tip Elev, Location

- P100(91) 1041.2/1029.1 Dyke
 - ▲ P92-05 1026.8/1019.0 Toe
 - × P92-27 1037.0/1034.9 Pond
- P92-04 1031.8/1027.2 Slope
 - ◆ P91-13 1029.7/1020.0 D/S Toe
 - Pond Elevation

Figure IV-5 STN 34 00

Line 38+00 Piezometer Readings

Iron Dike (Emergency Storage Pond)

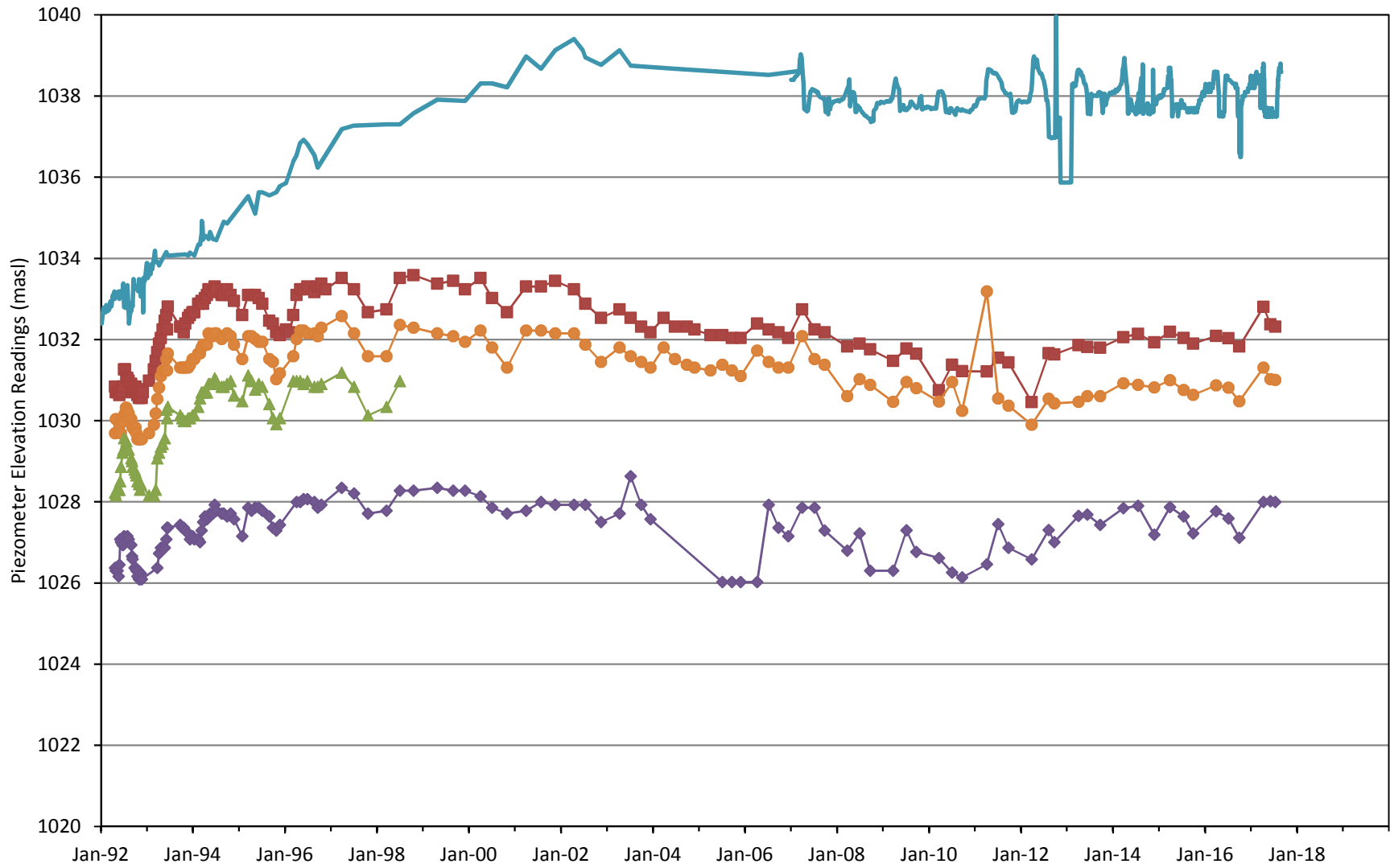

Legend = Piezo #, Ground Elev / Tip Elev, Location

- P92-06 1034.8/1024.2 Dyke
- P92-07 1034.1/1029.6 Slope
- ▲ P92-08 1031.8/1027.7 Slope
- ◆ P92-09 1029.3/1025.3 Toe
- Pond Elevation

Figure IV-6 STN 38 00

Line 42+00 Piezometer Readings

Iron Dike (Emergency Storage Pond)

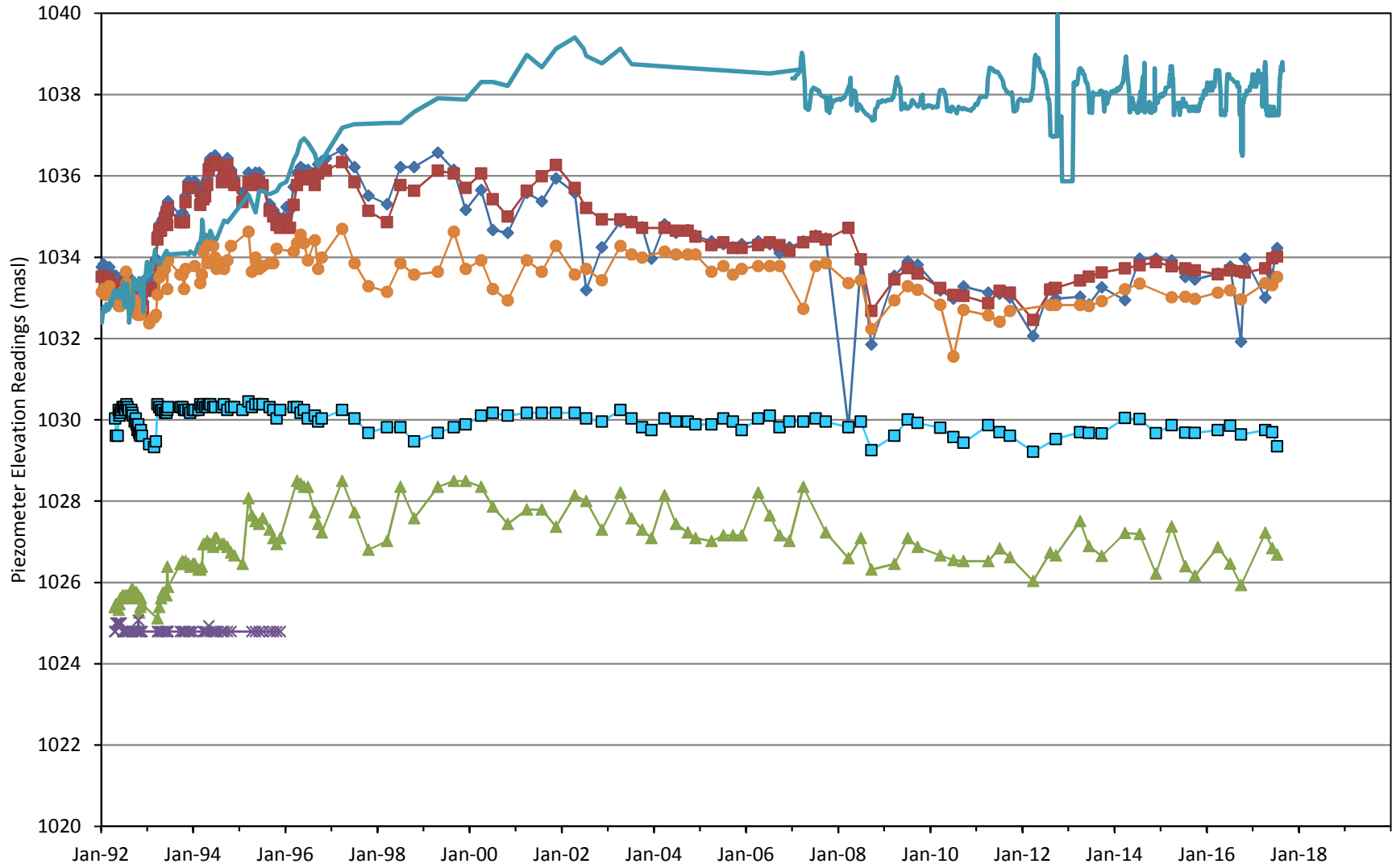

Legend = Piezo #, Ground Elev / Tip Elev, Location

- ▲ P92-11 1029.9/1025.0 Toe
- ◆ P91-11A 1042.4/1027.0 Dyke
- P91-11B 1042.3/1029.9 Dyke
- P91-12 1040.9/1029.8 Slope
- × P92-12 1029.6/1024.9 D/S Toe
- P92-16 1030.7/1027.6 Slope
- Pond Elevation

Figure IV-7 STN 42 00

Line 45+00 Piezometer Readings

Iron Dike (Emergency Storage Pond)

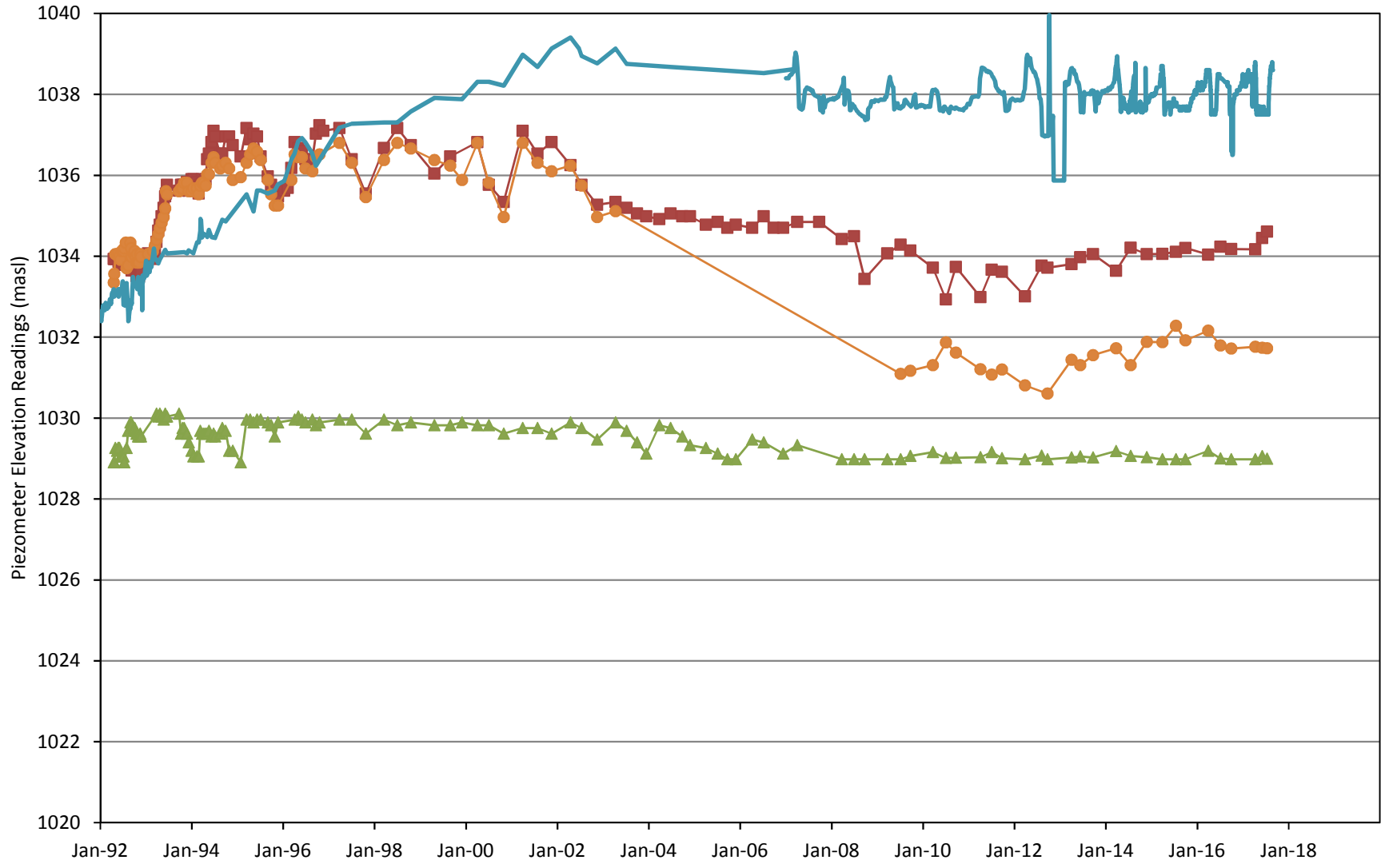

Legend = Piezo #, Ground Elev / Tip Elev, Location

- P92-13 1040.5/1031.3 Dyke
- P92-14 1037.4/1029.6 Slope
- ▲ P92-15 1030.3/1029.0 Toe
- Pond Elevation

Figure IV8 STN 45 00

Toe Piezometer Readings

Iron Dike (Emergency Storage Pond)

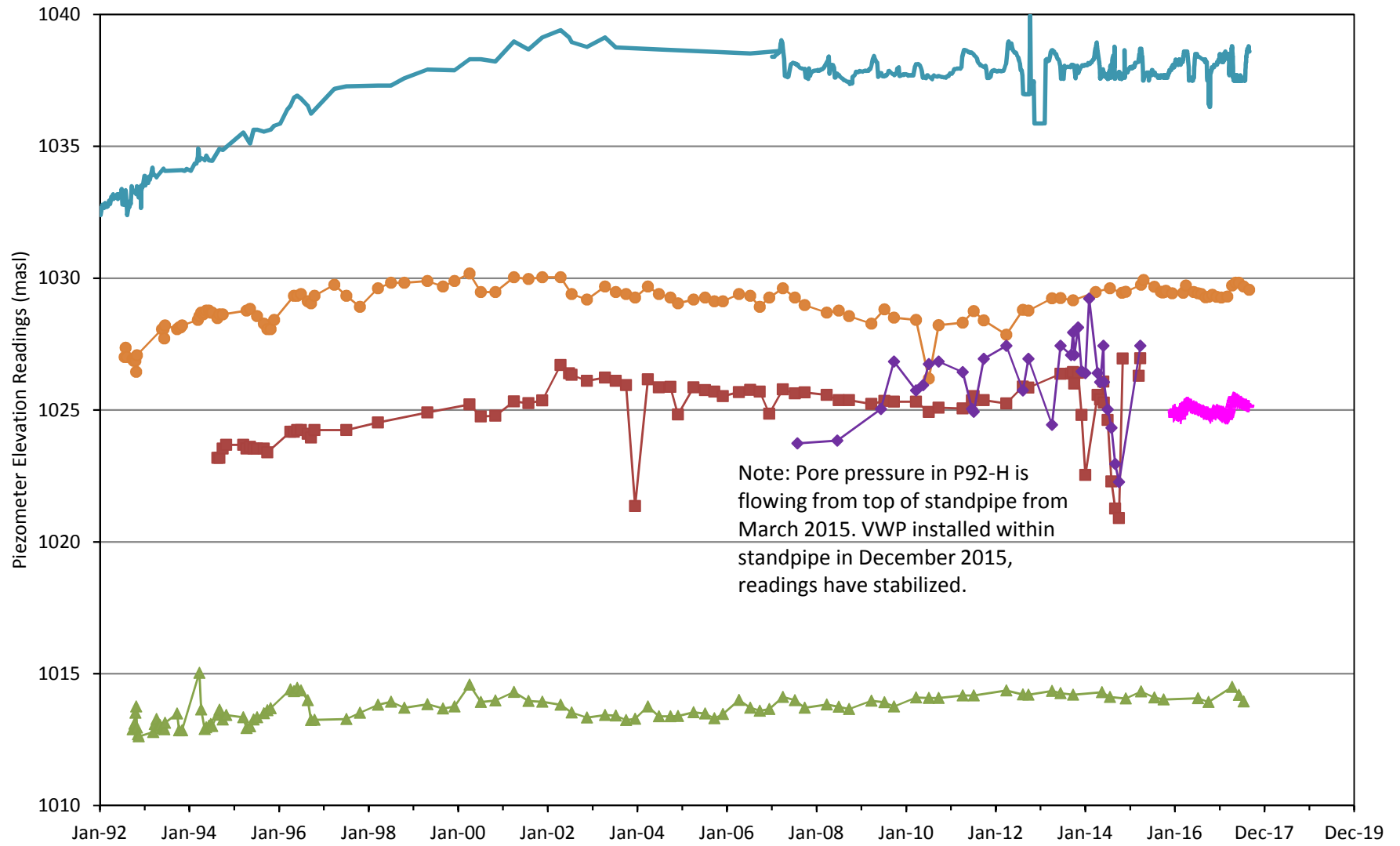

Legend = Piezo #, Ground Elev / Tip Elev, Location

- P92-H 1026.9/998.2 21+00
 - ▲ P92-26 1020.4/1009.1 16+00
 - Pond Elevation
- P92-25 1022.9/999.0 28+00
 - ◆ P92-H Manometer Measurement
 - P92-H 1025.6/997.2

Figure IV-9 Toe Piezos

IRON POND WEIR #3 (AIPWU) FLOWS

(EMERGENCY STORAGE POND)

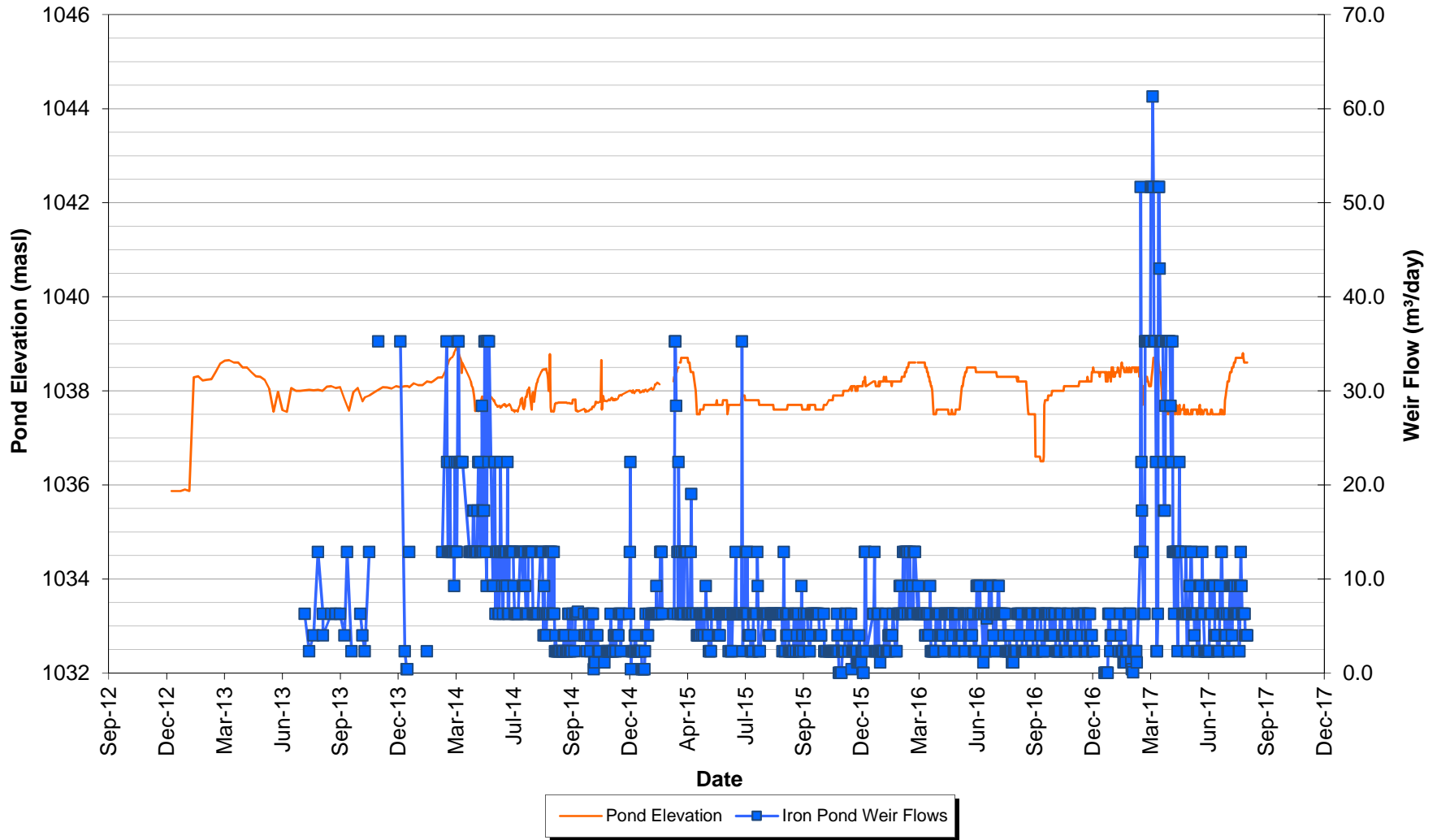

Figure IV-10 Weir #3 - AIP (AIPWU) time plot

IRON POND WEIR #4 FLOWS (EMERGENCY STORAGE POND)

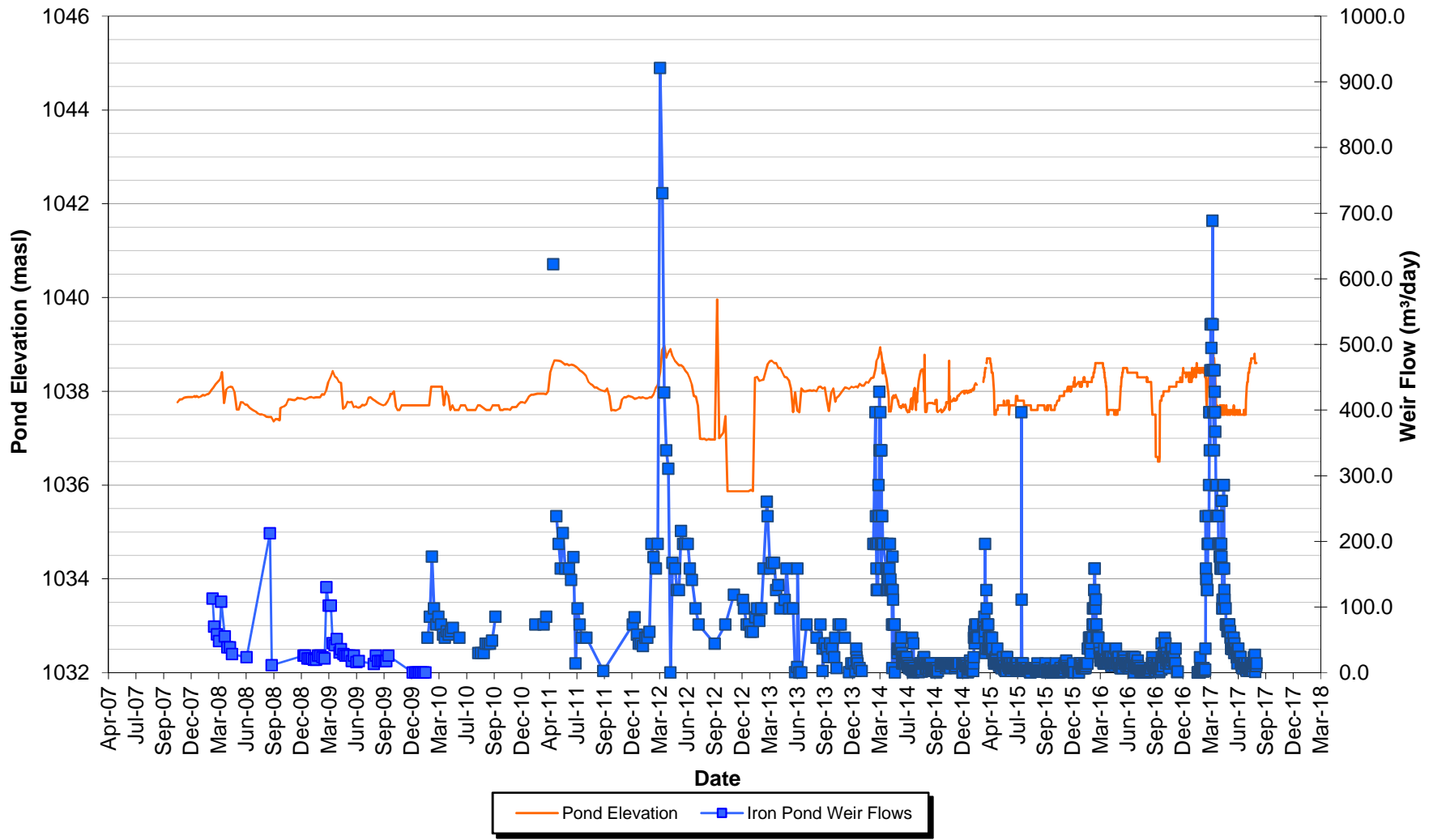

Figure IV-11 Weir #4 - AIP_OLD time plot

Active Settlement Plate Data

Iron Pond Dike (Emergency Storage Pond)

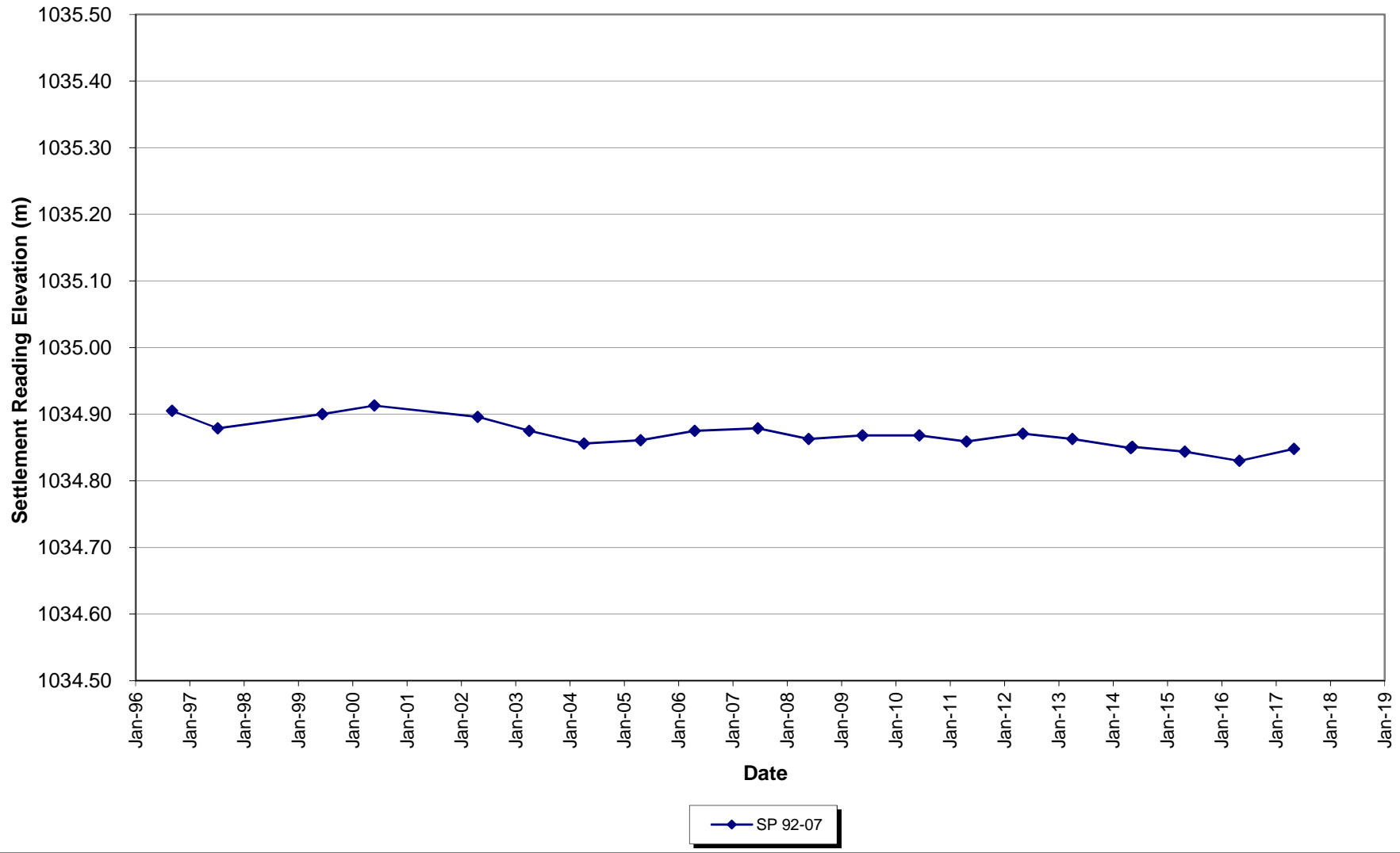

Figure IV-12 SP 92-07

Active Settlement Plate Data

Iron Pond Dike (Emergency Storage Pond)

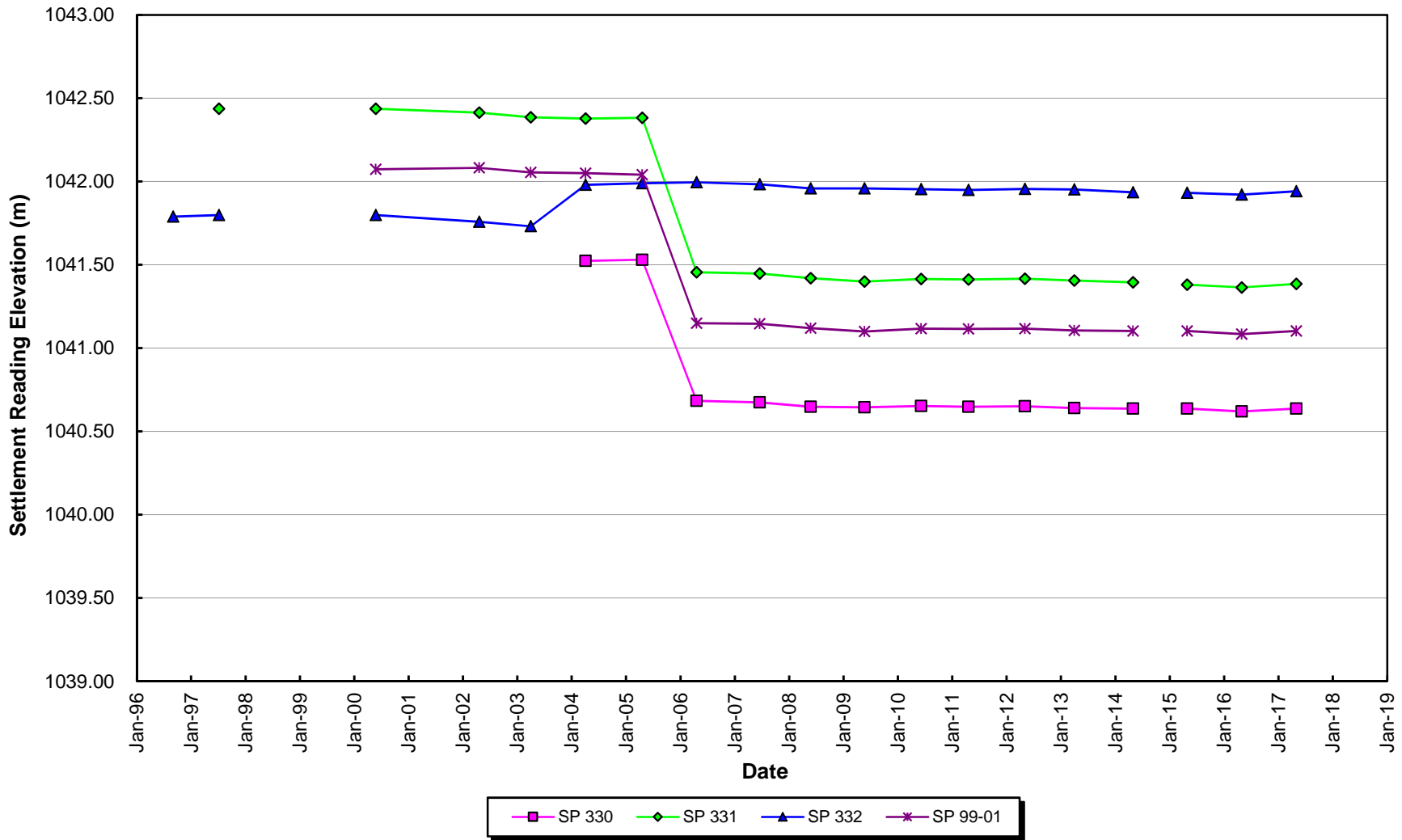

Figure IV-13 SP 330 - 332 and SP 99-01

APPENDIX V

Old Iron Dike Instrumentation Data

Southwest Limb Buttress Piezometer Readings

Old Iron Pond Dike

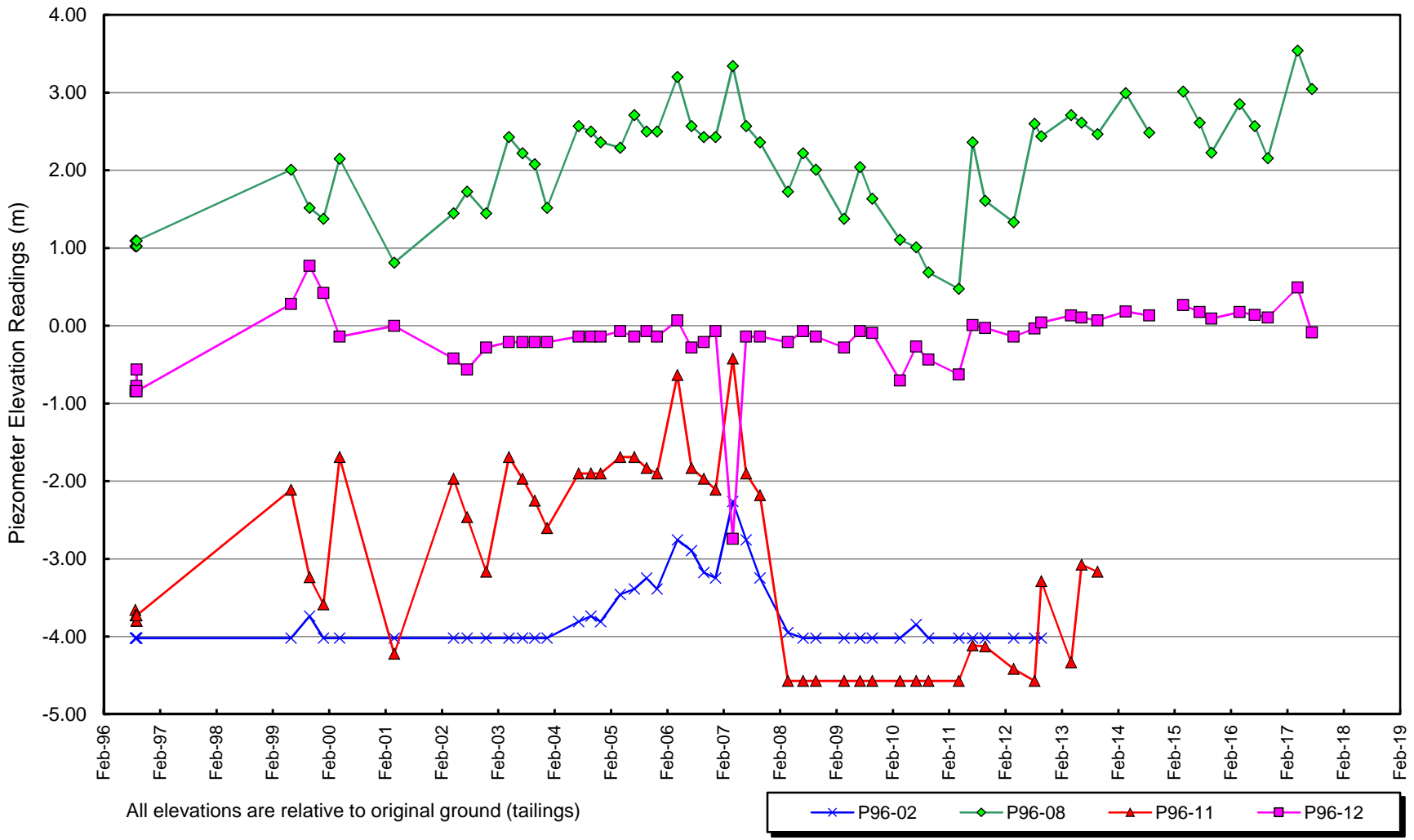
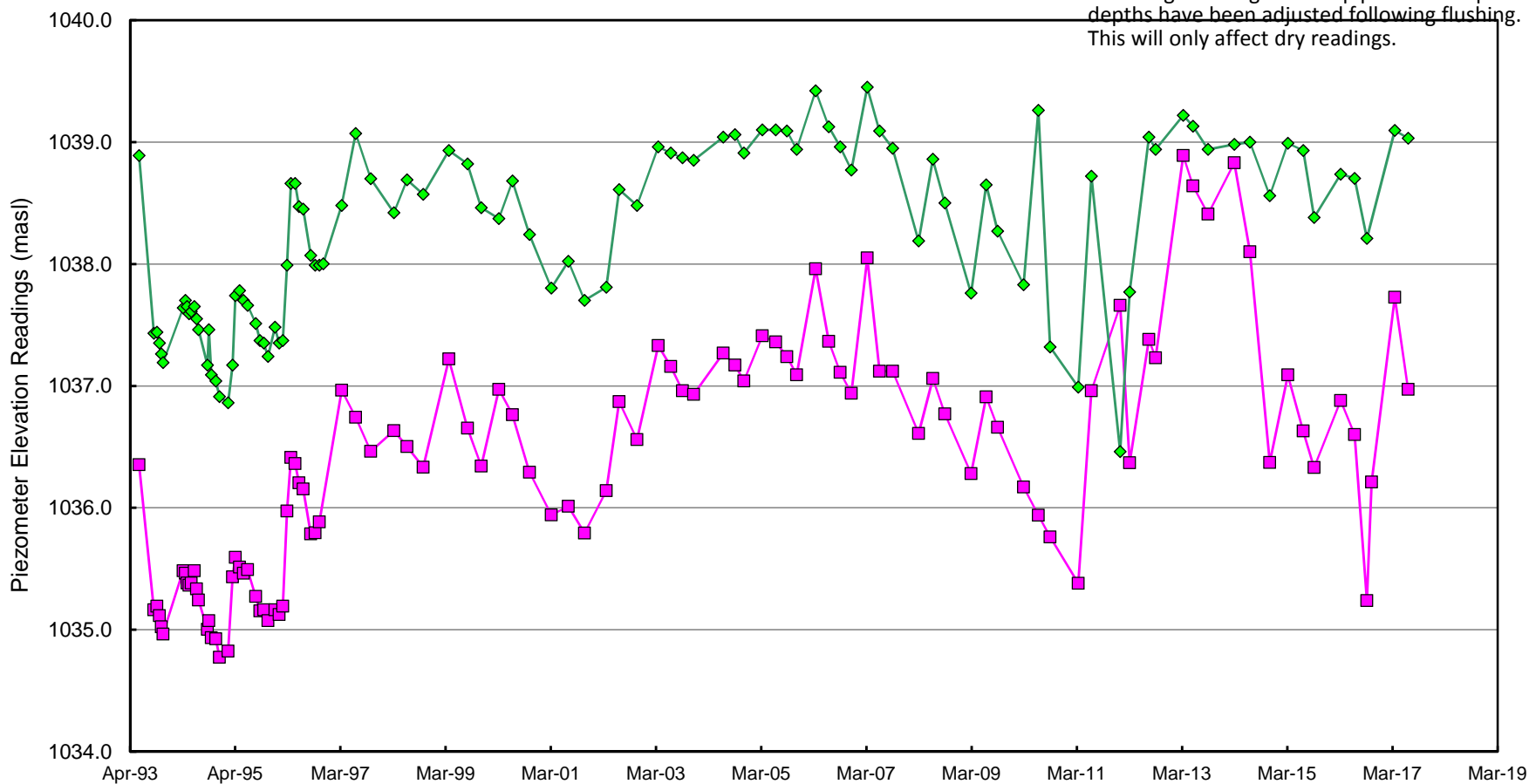

Figure V-1 SWL_BUTTRESS

Southwest Limb Piezometer Readings

Old Iron Pond Dike

August 2014 depth to bottom measured following flushing of standpipes. Some tip depths have been adjusted following flushing. This will only affect dry readings.



Legend = Piezo #, Ground Elev / Tip Elev

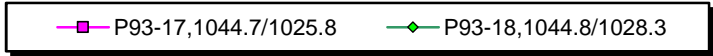
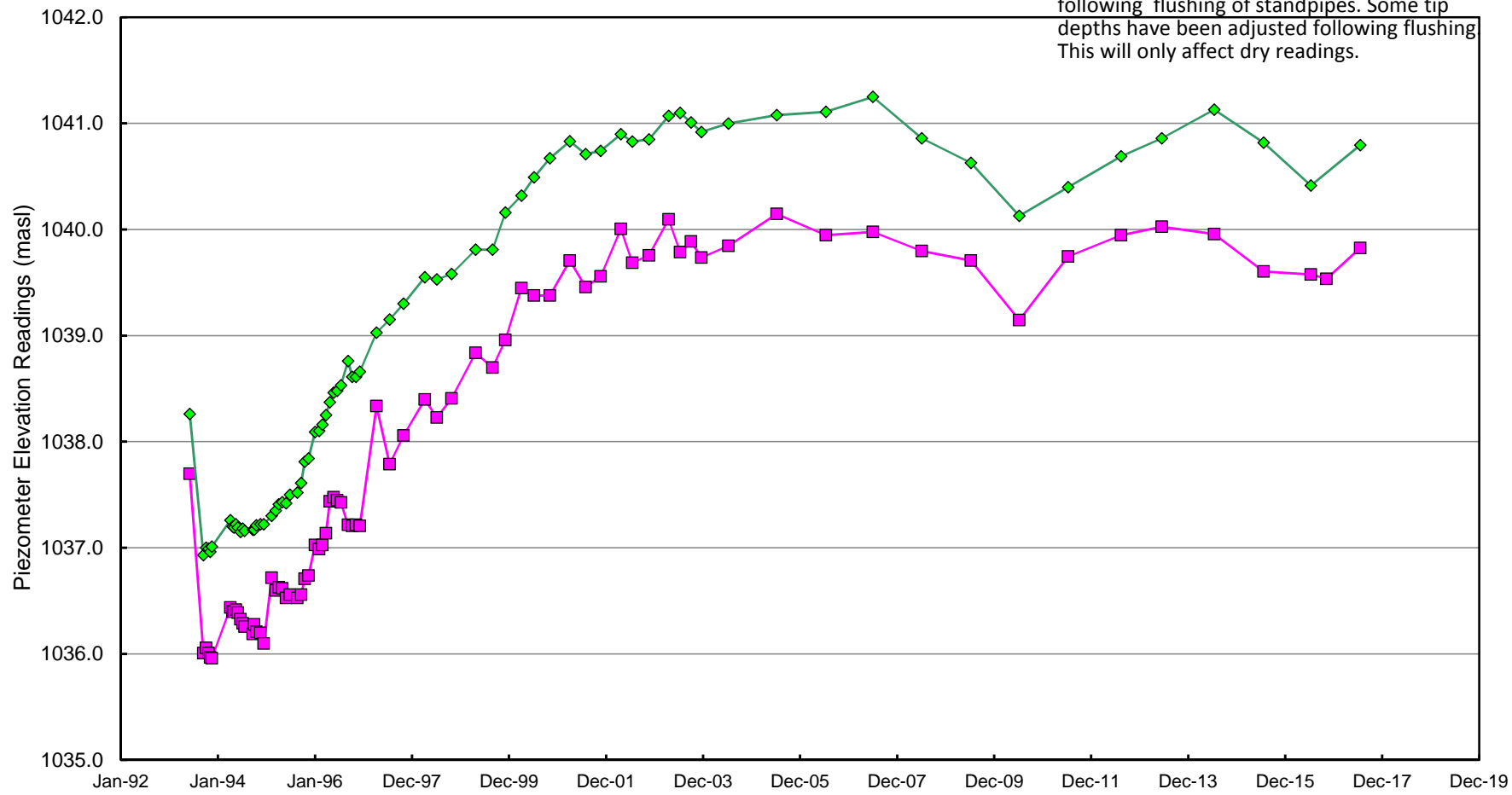

Figure V-2 SW Limb

Southeast Limb Piezometer Readings

Old Iron Pond Dike

August 2014 depth to bottom measured following flushing of standpipes. Some tip depths have been adjusted following flushing. This will only affect dry readings.



Legend = Piezo #, Ground Elev / Tip Elev

| | |
|--|--|
| ■ P93-19, 1042.4/1025.6 | ◆ P93-20, 1044.3/1026.4 |
|--|--|

Figure V-3 SE Limb

APPENDIX VI

Siliceous Dikes Instrumentation Data

East Side Piezometer Readings

Sullivan Concentrator #1 Siliceous Pond Dyke

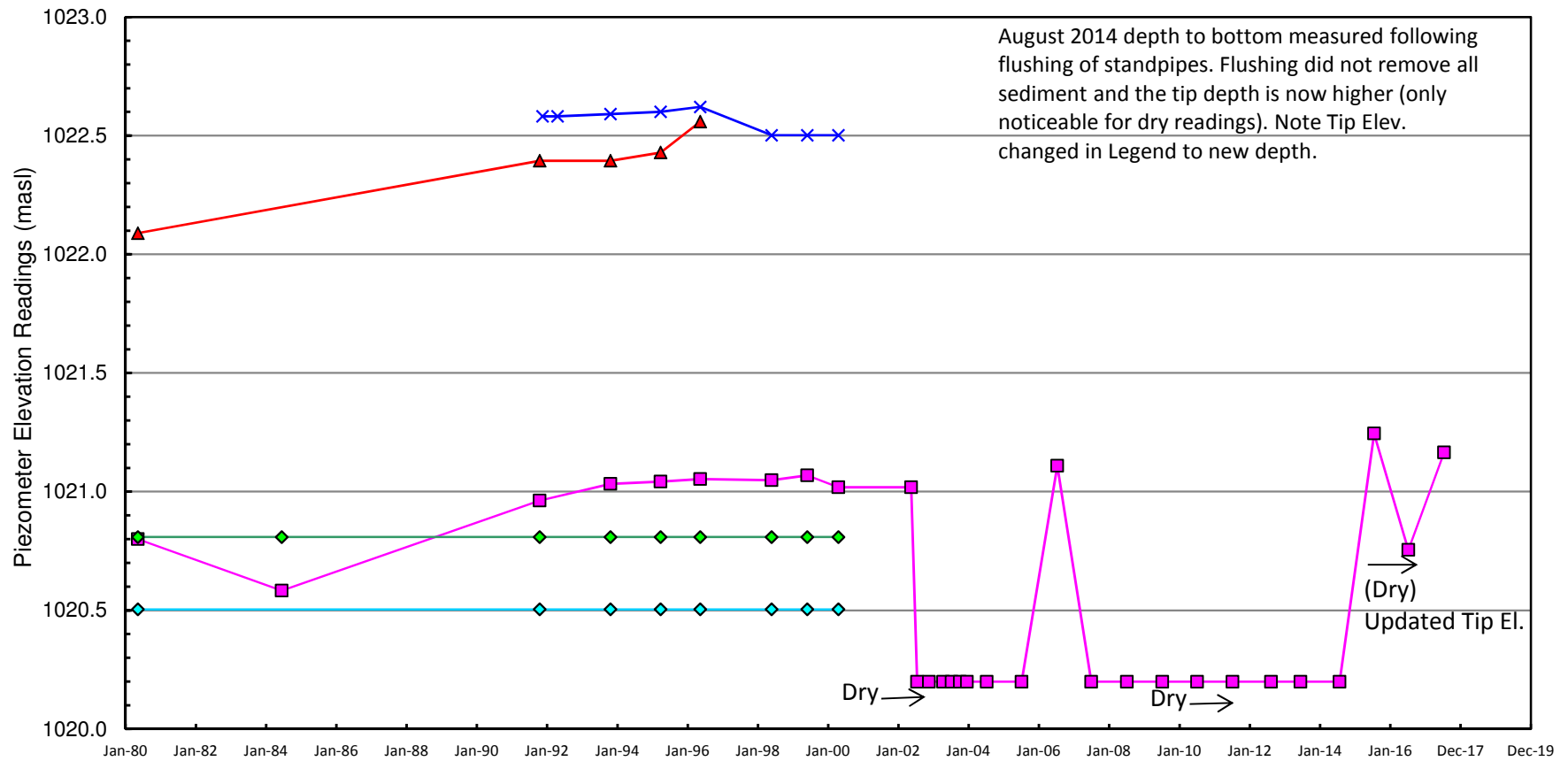

Legend = Piezo #, Ground Elev / Tip Elev

| | | |
|--------------------------|---------------------------|-------------------------|
| —x— P4, 1039.7/1022.3 | —■— SP106, 1034.7/1020.76 | —▲— P107, 1034.2/1022.3 |
| —◇— SP108, 1035.4/1021.1 | —◇— P109, 1033.0/1020.8 | |

Figure VI-1 EAST

Middle Piezometer Readings

Sullivan Concentrator #1 Siliceous Pond Dyke

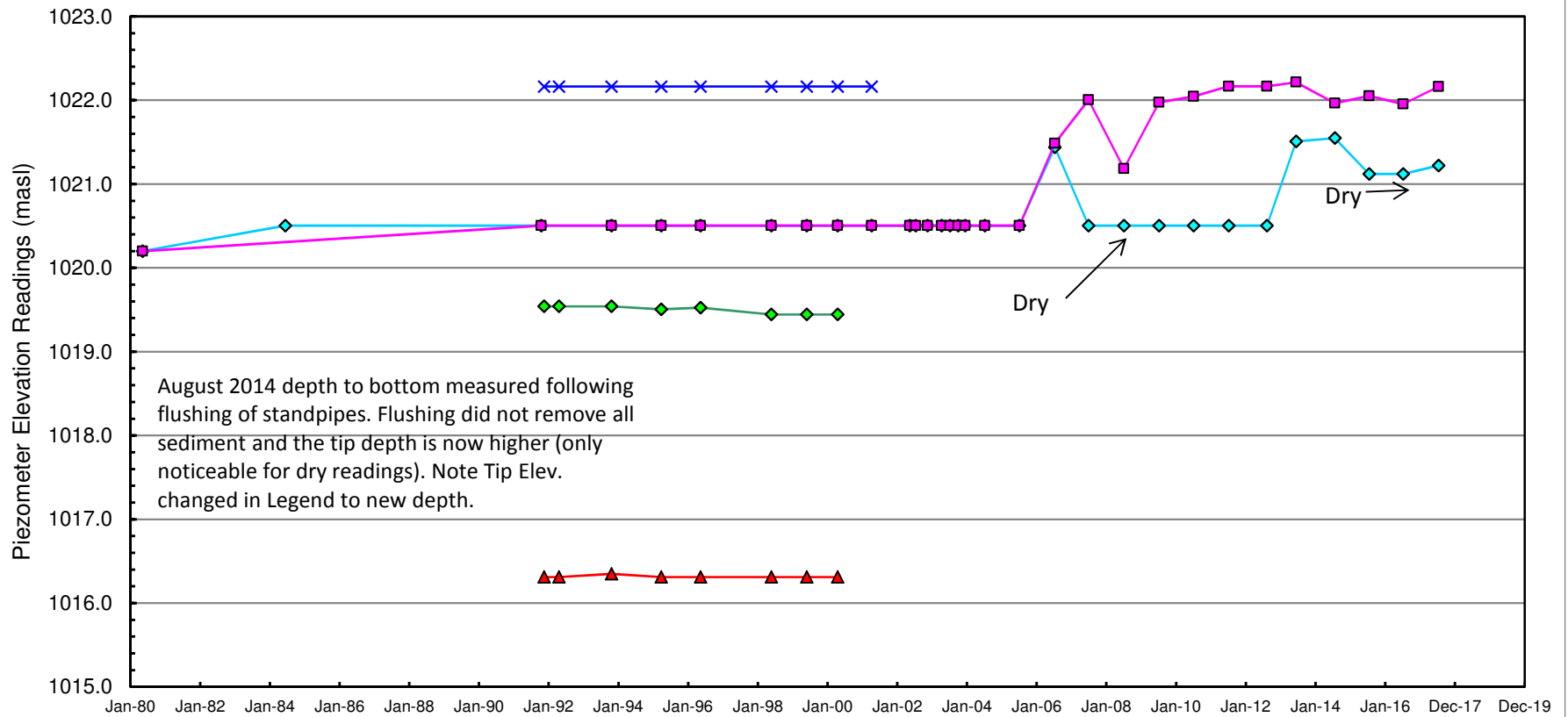

Legend = Piezo #, Ground Elev / Tip Elev

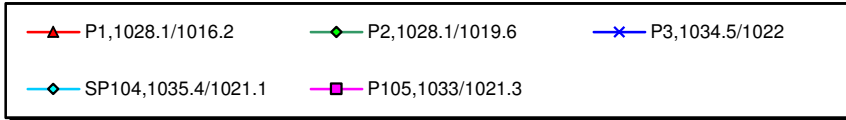
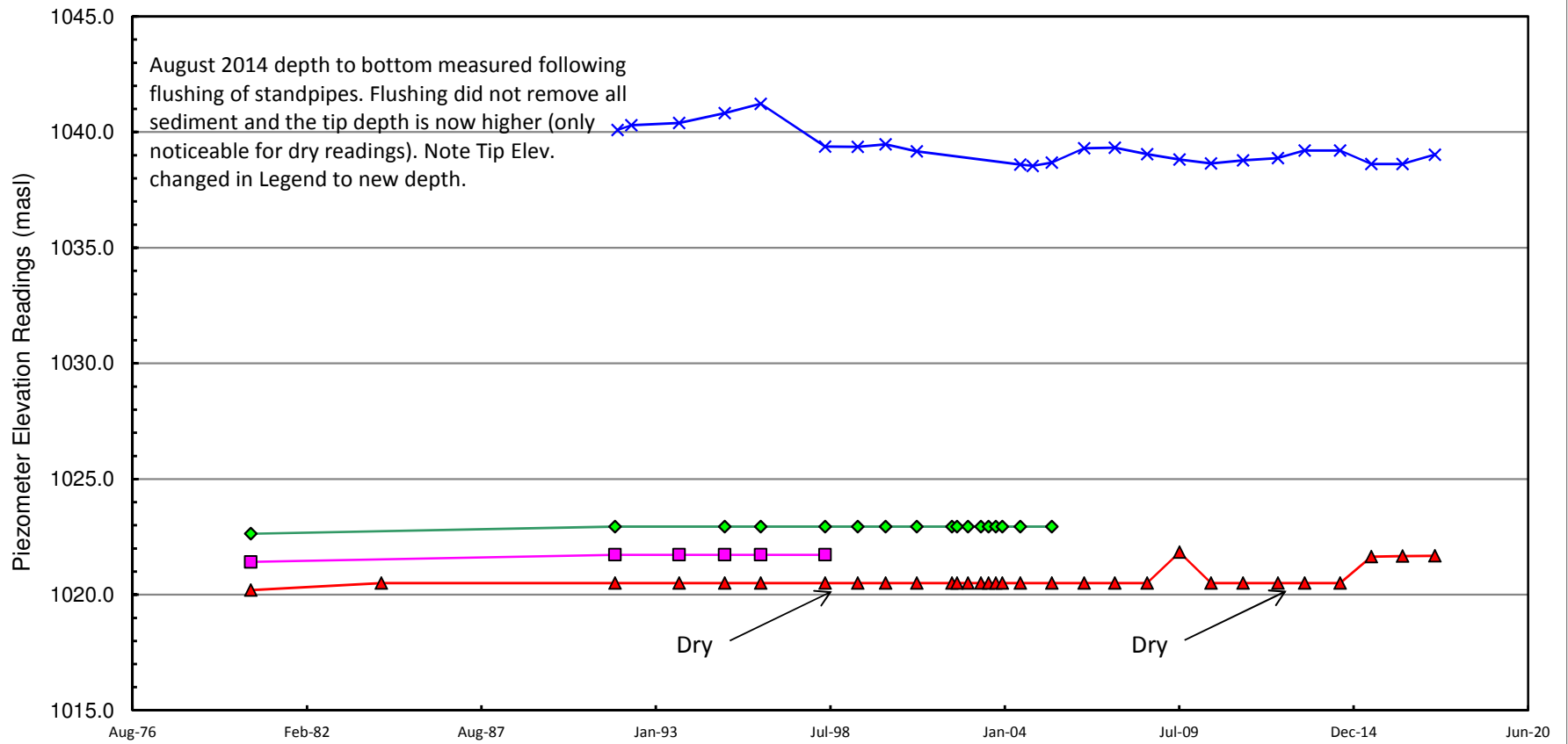

Figure VI-2 MIDDLE

West Side Piezometer Readings

Sullivan Concentrator #1 Siliceous Pond Dyke



Legend = Piezo #, Ground Elev / Tip Elev



Figure VI-3 WEST

Piezometer Readings Along Crest

Sullivan Concentrator #2 Siliceous Pond

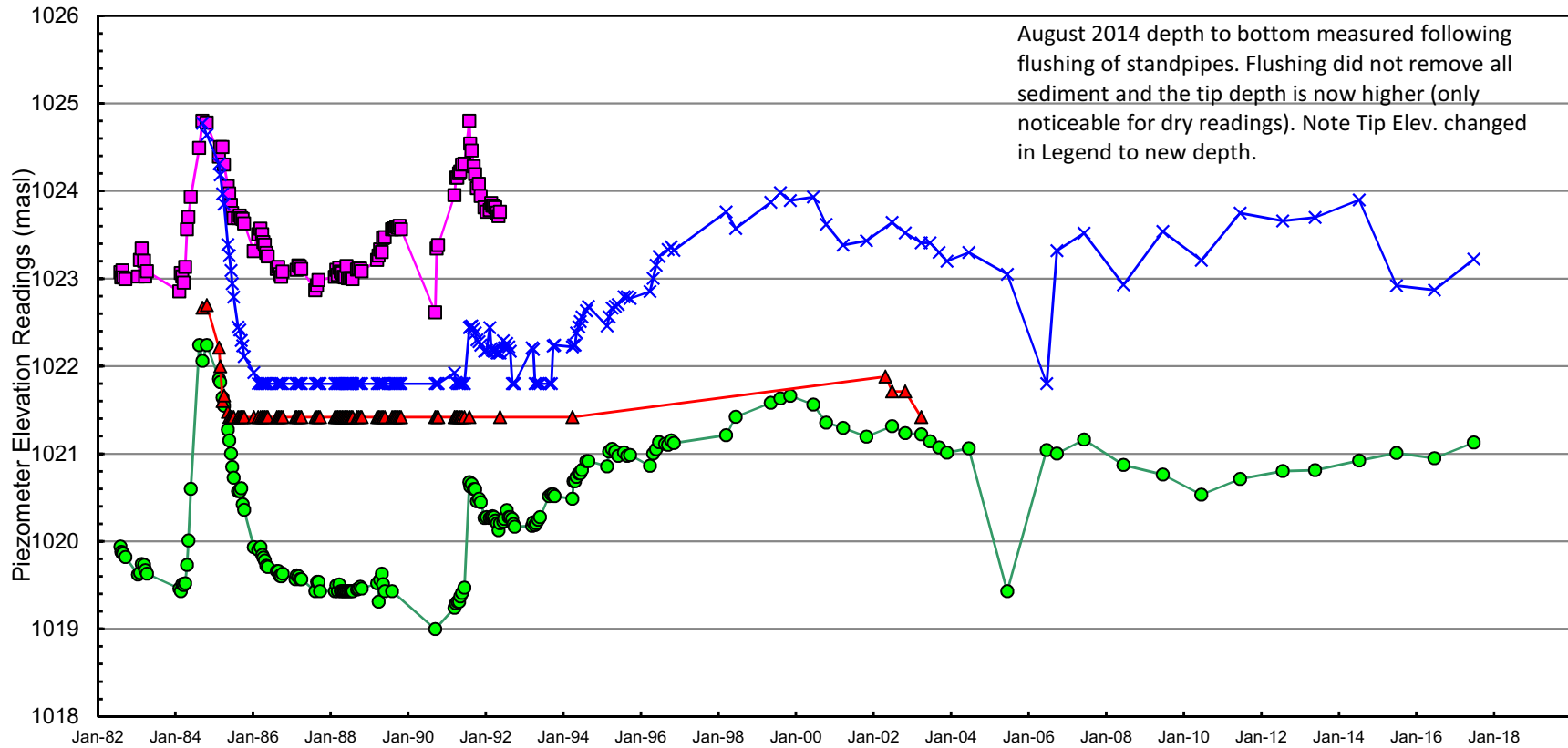

Legend = Piezo #, Ground Elev/Tip Elev,

—■— P230 1027.78/1021.4 3400 slope 82dyke

—●— P231 1031.2/1019.5 middle slope 82 dyke

—×— P257 1031.3/1022.0 middle crest 82dyke

—▲— P258 1031.5/1021.4 east crest 80dyke

Figure VI-4 Sil2 Crest

Lines 3+00/7+00 Piezometer Readings

Sullivan Concentrator #3 Siliceous Pond

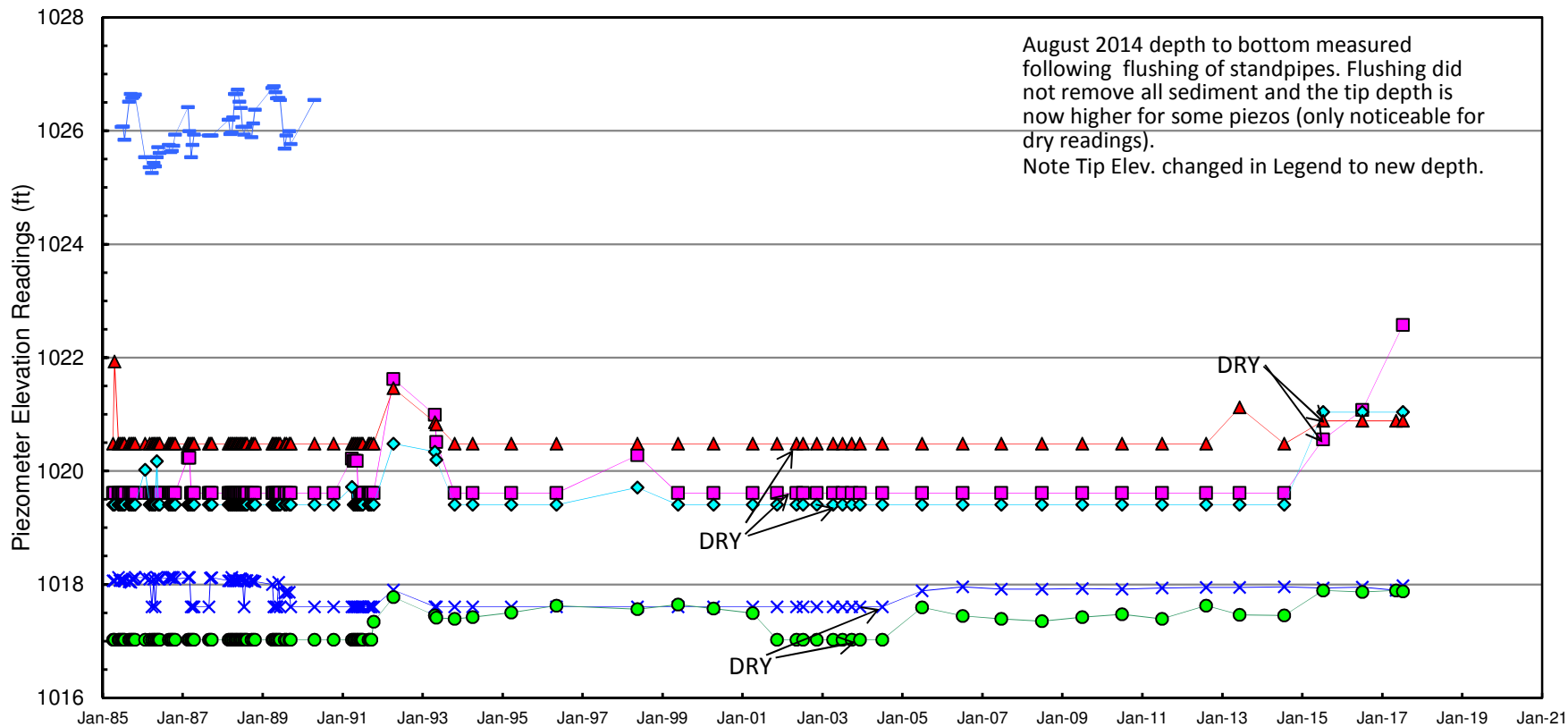

Legend = Piezo #, Ground Elev / Tip Elev,
Chainage from #2 divider dyke in Feet, Location

| | | |
|------------------------------------|------------------------------------|------------------------------------|
| —●— Pond Elevation | —■— P301 1030.44/1020.6 3+00 crest | —◆— P302 1026.21/1021.0 3+00 slope |
| —▲— P303 1030.87/1019.5 6+00 crest | —×— P232 1027.27/1017.4 7+00 slope | —●— P233 1023.79/1017.9 7+00 slope |

Figure VI-5 Sil 3 Pond South

APPENDIX VII

West Gypsum Dike Instrumentation Data

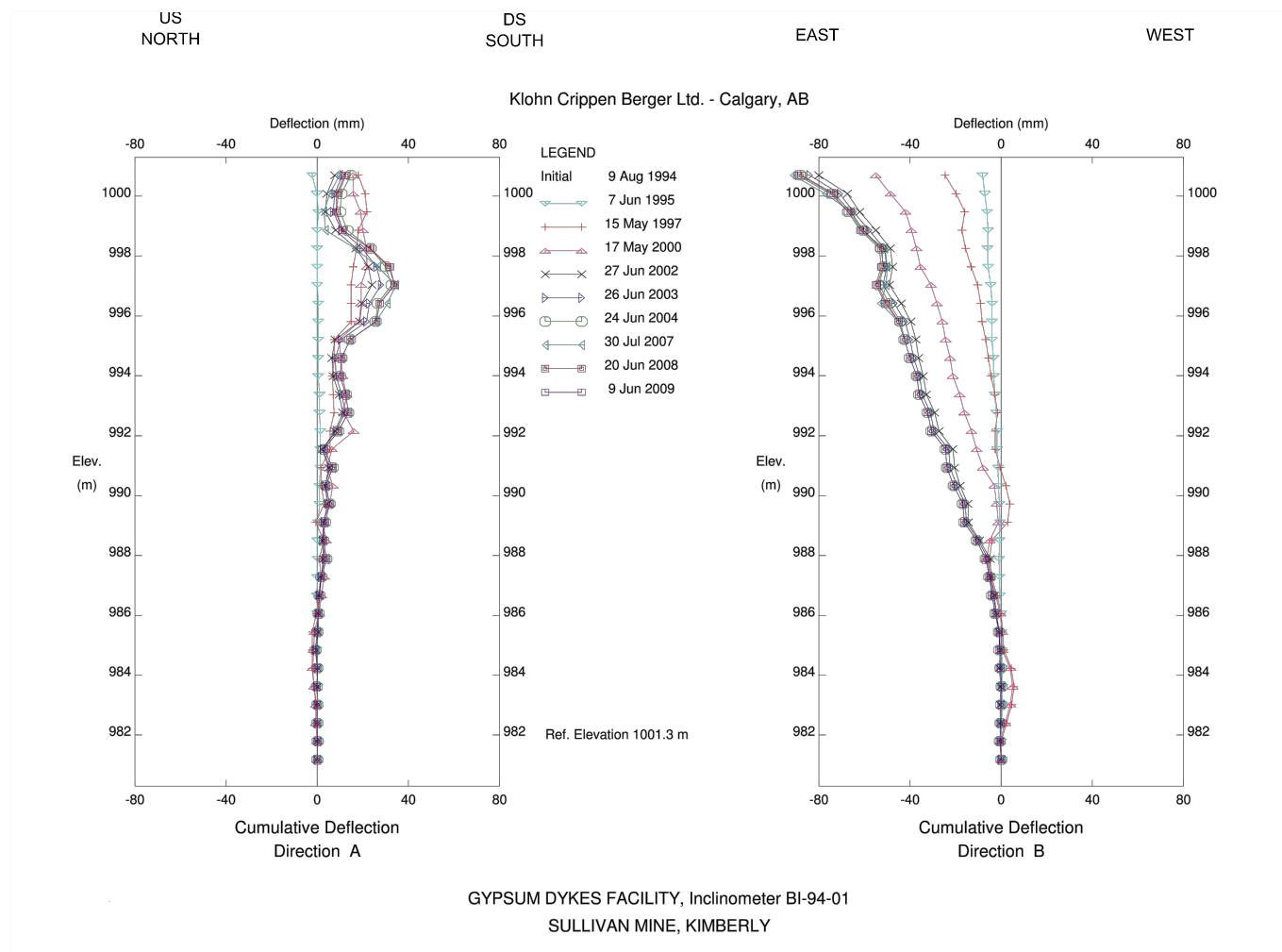

(CAN NO LONGER READ. BLOCKED AT 4.7 m BELOW THE GROUND SURFACE)

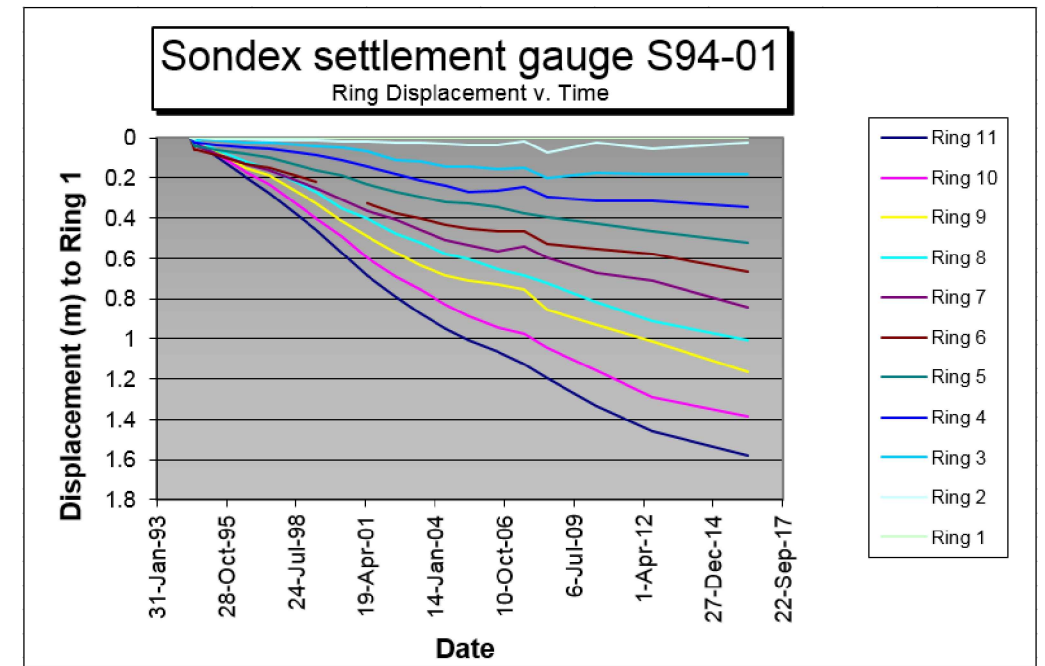
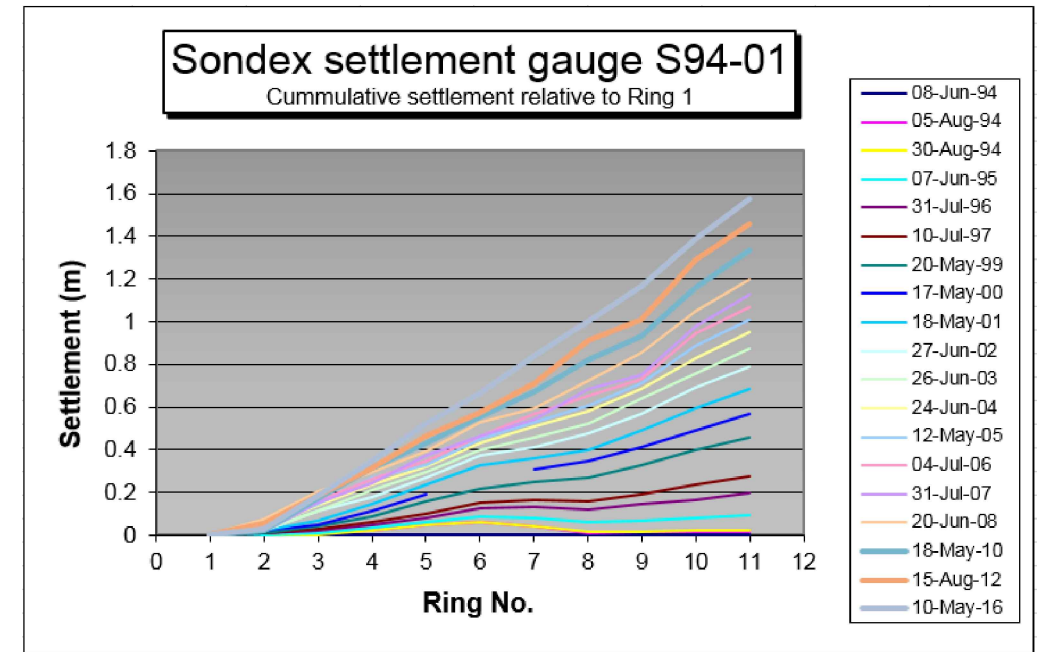

| | | | |
|---|--|---|-----------|
| AS A MUTUAL PROTECTION TO OUR CLIENT, THE PUBLIC AND OURSELVES, ALL REPORTS AND DRAWINGS ARE SUBMITTED FOR THE CONFIDENTIAL INFORMATION OF OUR CLIENT FOR A SPECIFIC PROJECT AND AUTHORIZATION FOR USE AND/OR PUBLICATION OF DATA STATEMENTS, CONCLUSIONS OR ABSTRACTS FROM OR REGARDING OUR REPORTS AND DRAWINGS IS RESERVED PENDING OUR WRITTEN APPROVAL. | CLIENT <h1 style="margin: 0;">Teck</h1> | PROJECT SULLIVAN MINE 2017 DAM SAFETY INSPECTION | |
| | | TITLE WEST GYPSUM DIKE SONDEX AND INCLINOMETER PLOTS | |
| | PROJECT No. | FIG. No. | A05807A17 |

A05807A17.dwg

KCC-F-BM

Line 10+00 Piezometer Readings

Sullivan Concentrator West Gypsum Pond Dike

August 2014 depth to bottom measured following flushing of standpipes. Flushing did not remove all sediment and the tip depth is now higher for some piezos (only noticeable for dry readings). Note Tip Elev. changed in Legend to new depth.

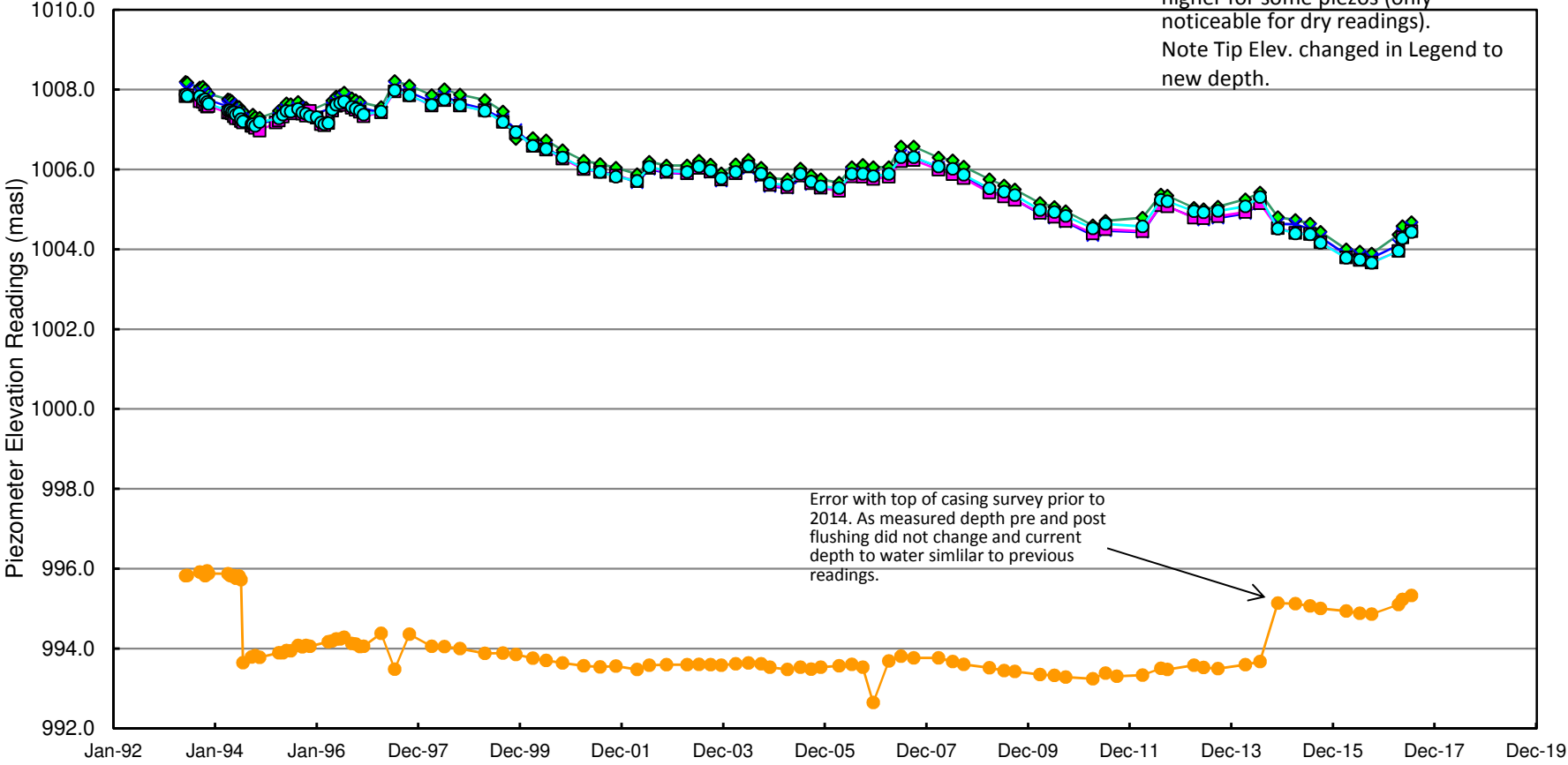
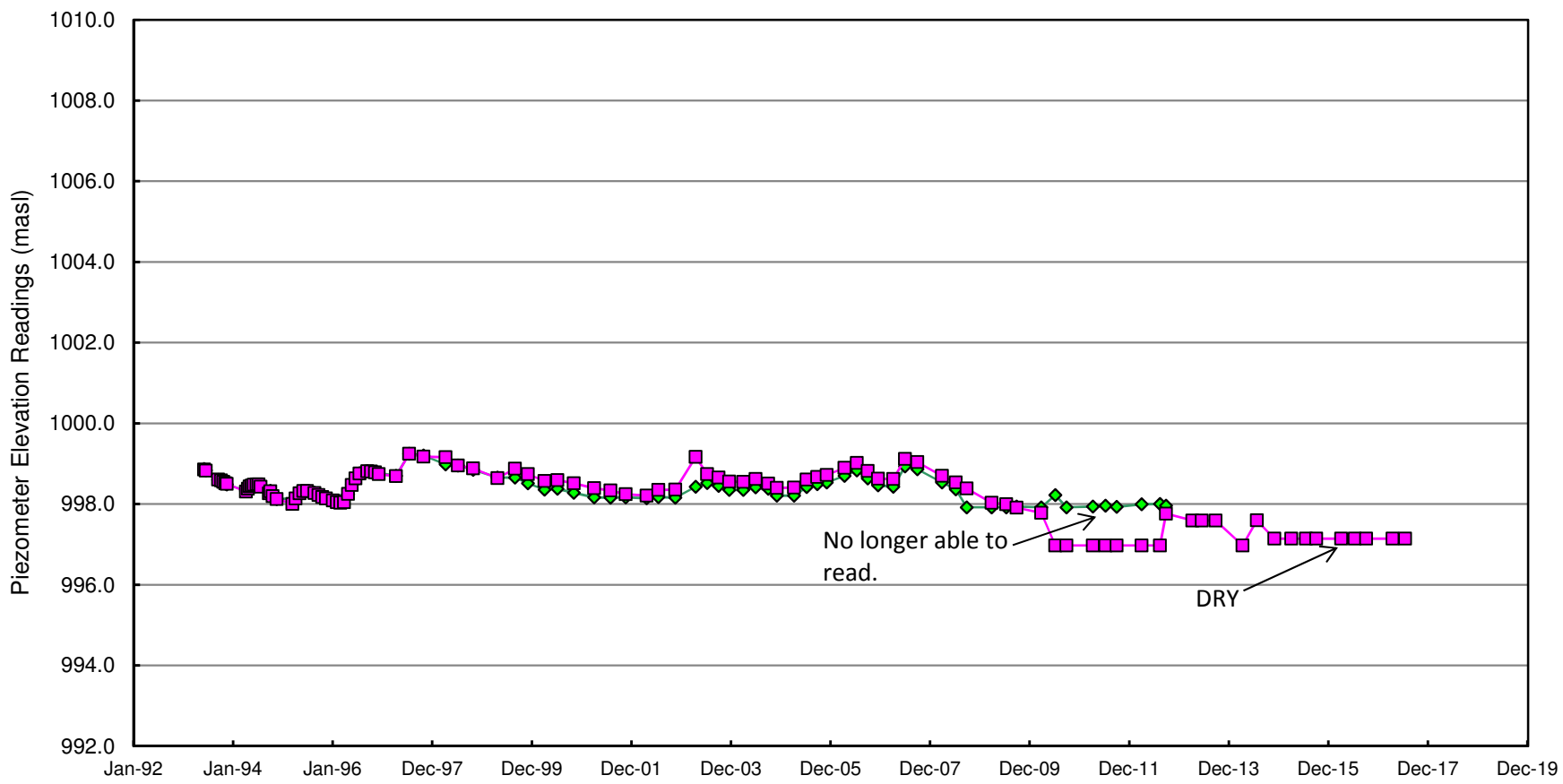

Figure VII-2 Line 10+00

Line 20+00 Piezometer Readings

Sullivan Concentrator West Gypsum Pond Dike



Legend = Piezo #, Ground Elev / Tip Elev

| | |
|---|---|
| ◆ P93-6,1014.4/998.9 | ■ P93-7,1017.2/997.2 |
|---|---|

Figure VII-3 Line 20+00

SETTLEMENT PLATES - WEST GYPSUM Dike

SP97-01 Line 10+00
SETTLEMENT PLATES - WEST GYPSUM Dike

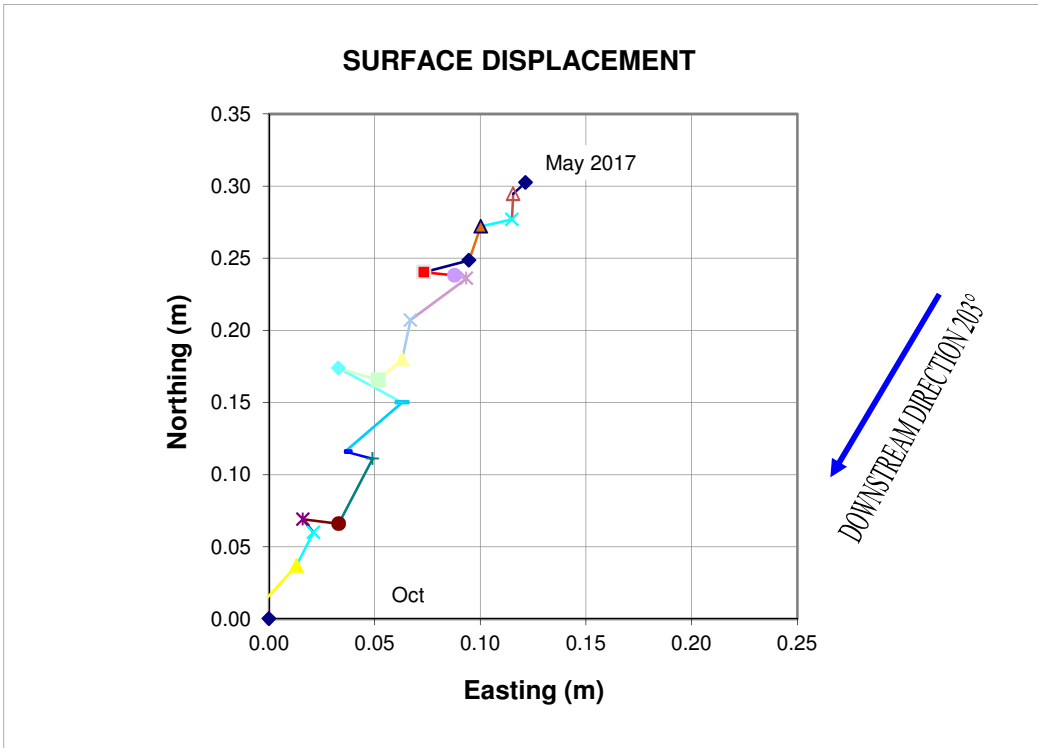
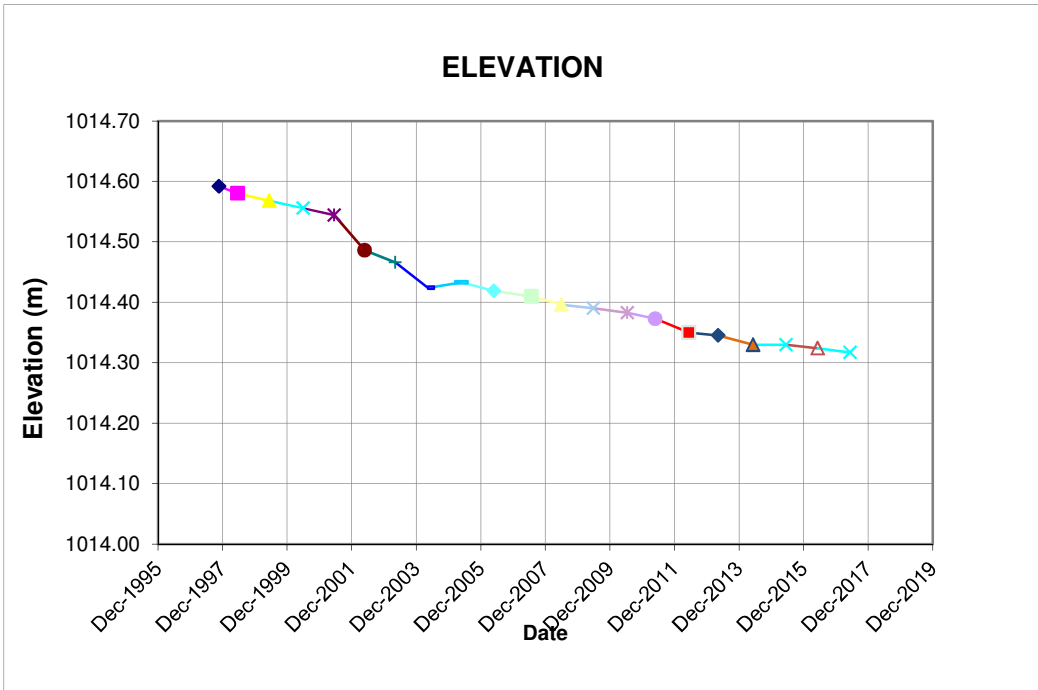

Figure VII-4-SP97-01

SETTLEMENT PLATES - WEST GYPSUM Dike

SP97-05 Line 10+00
SETTLEMENT PLATES - WEST GYPSUM Dike

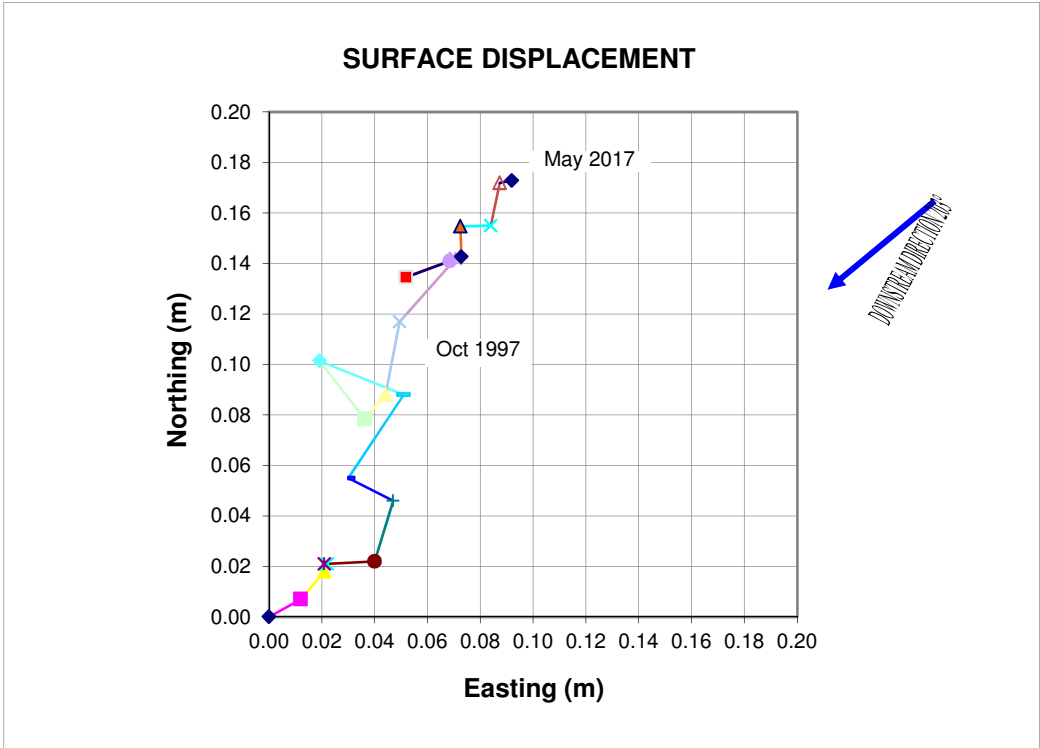
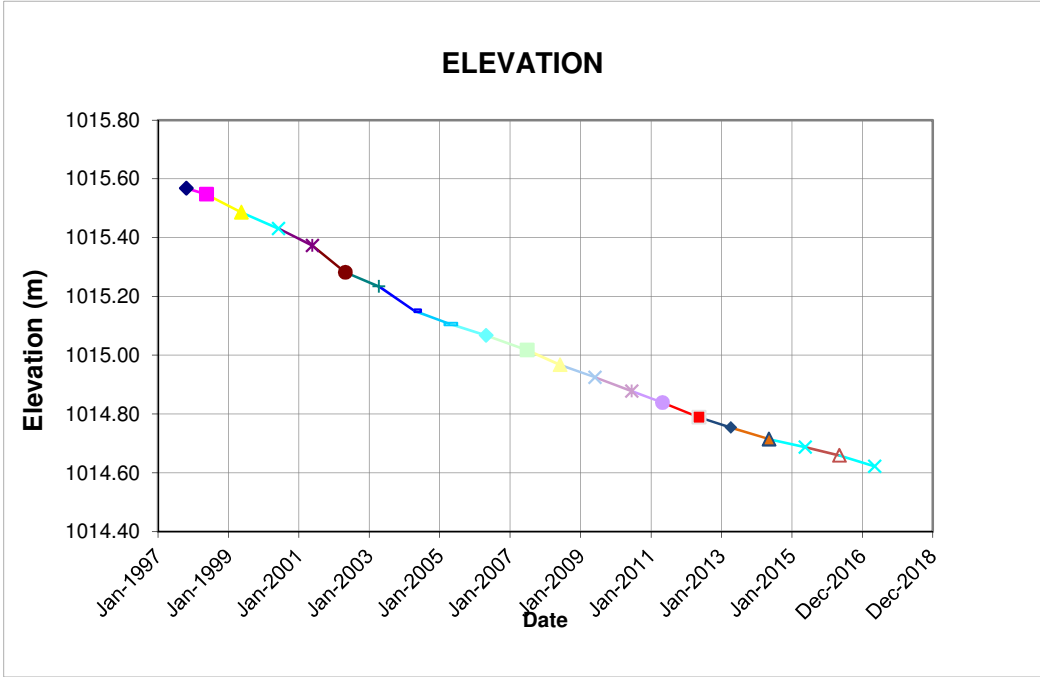

Figure VII-5-SP97-05

SETTLEMENT PLATES - WEST GYPSUM Dike

SP97-06 Line 20+00
SETTLEMENT PLATES - WEST GYPSUM Dike

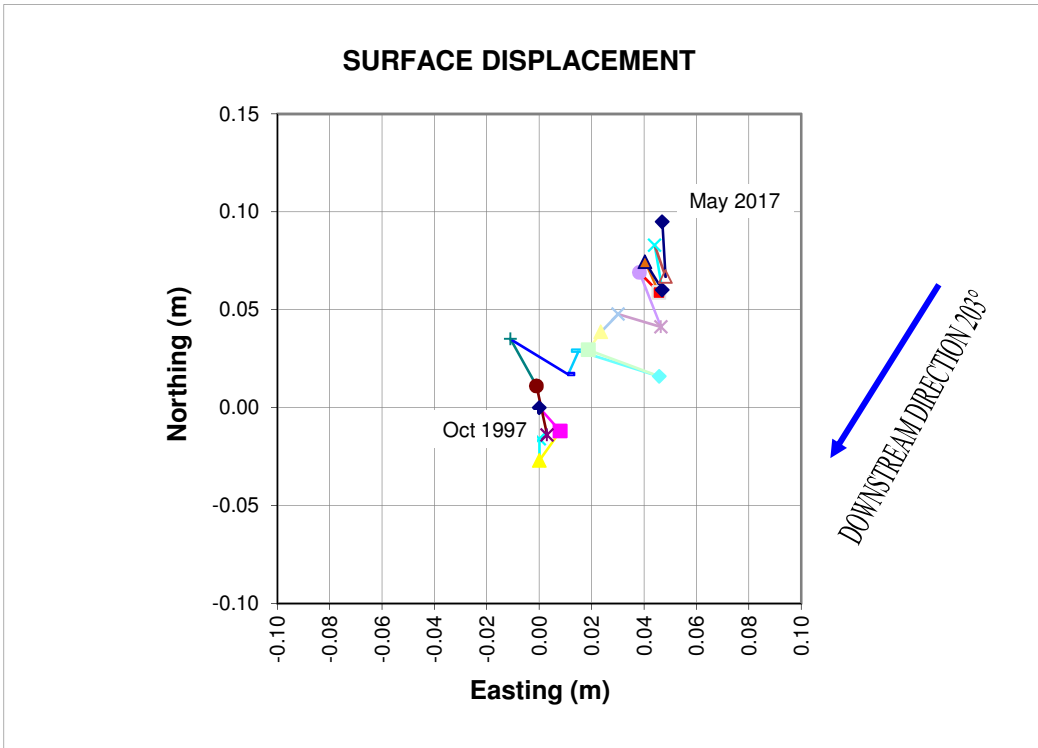
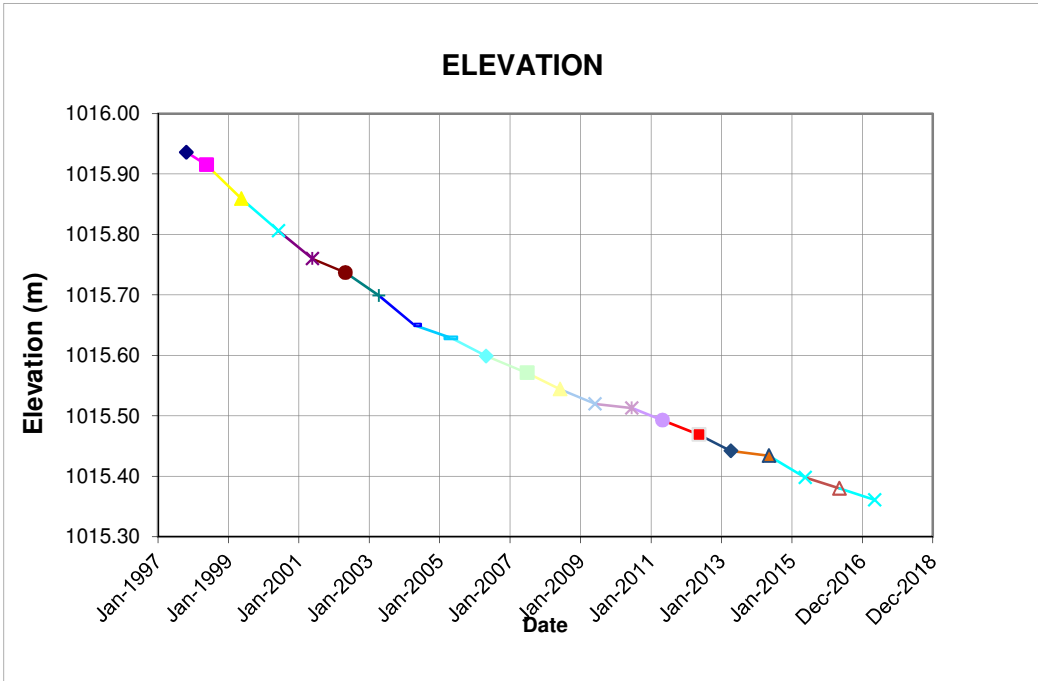
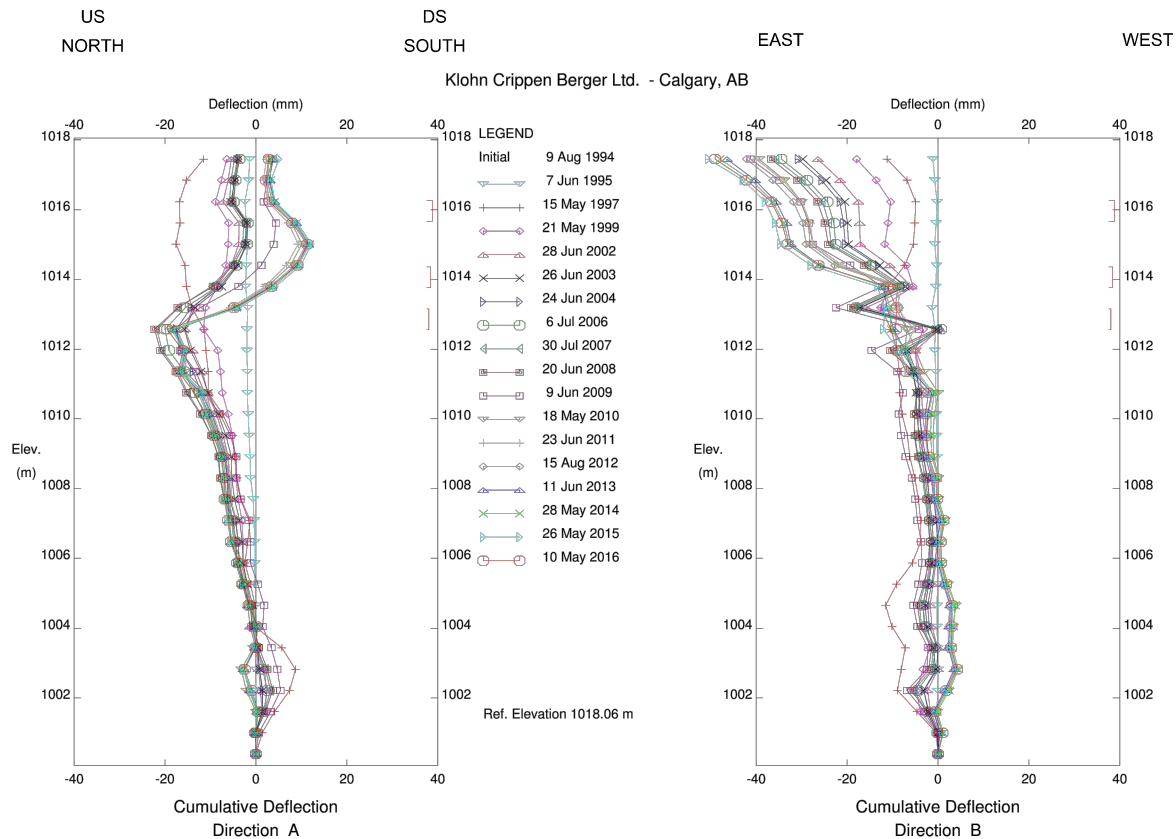

Figure VII-6-SP97-06

APPENDIX VIII

East Gypsum Dike Instrumentation Data



GYPSSUM DYKES FACILITY, Inclinator BI-94-02
SULLIVAN MINE, KIMBERLEY

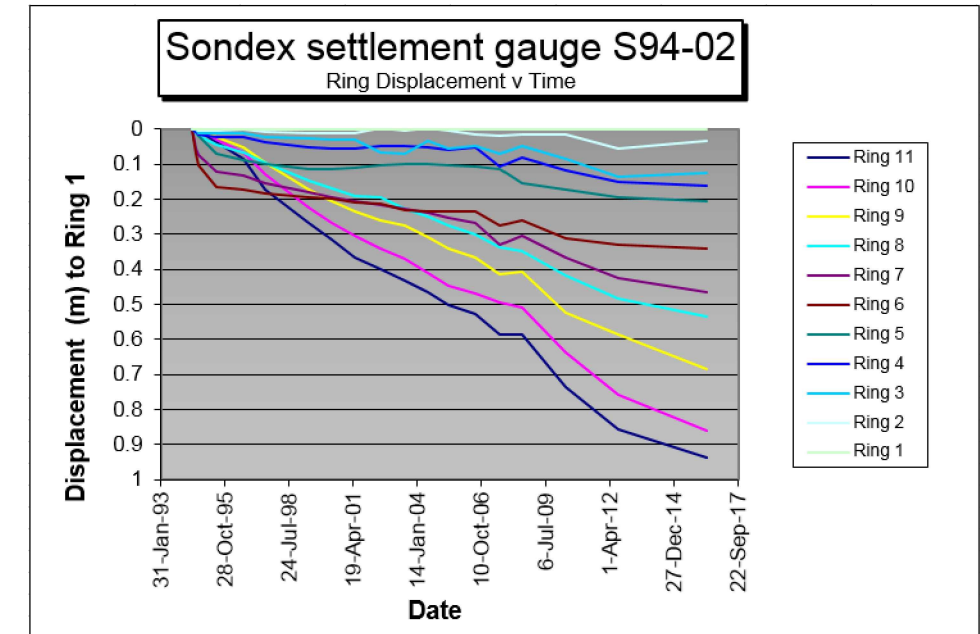
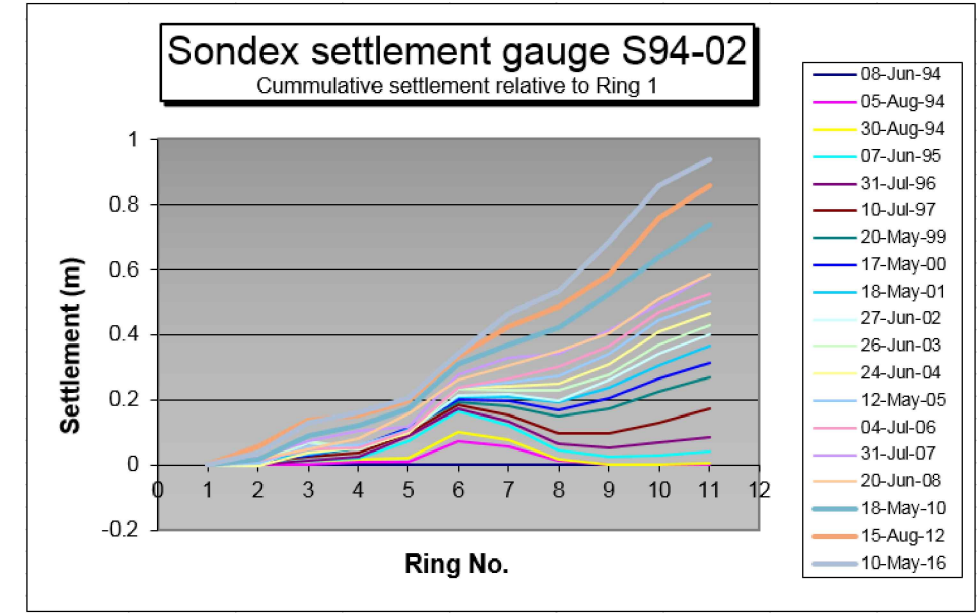

| | | | |
|---|---|---|----------------------------------|
| AS A MUTUAL PROTECTION TO OUR CLIENT, THE PUBLIC AND OURSELVES, ALL REPORTS AND DRAWINGS ARE SUBMITTED FOR THE CONFIDENTIAL INFORMATION OF OUR CLIENT FOR A SPECIFIC PROJECT AND AUTHORIZATION FOR USE AND/OR PUBLICATION OF DATA STATEMENTS, CONCLUSIONS OR ABSTRACTS FROM OR REGARDING OUR REPORTS AND DRAWINGS IS RESERVED PENDING OUR WRITTEN APPROVAL. | Teck | PROJECT SULLIVAN MINE 2017 DAM SAFETY INSPECTION | |
| |  | TITLE EAST GYPSSUM DIKE SONDEX AND INCLINOMETER PLOTS | |
| | | PROJECT No. A05807A17 | FIG. No. FIGURE VIII-1 |

A05807A17.FIGure VIII-1.dwg

KCC-F-BM

Line 33+00 New Piezometer Readings

Sullivan Concentrator East Gypsum Pond Dike

August 2014 depth to bottom measured following flushing of standpipes. Flushing did not remove all sediment and the tip depth is now higher for some piezos (only noticeable for dry readings).

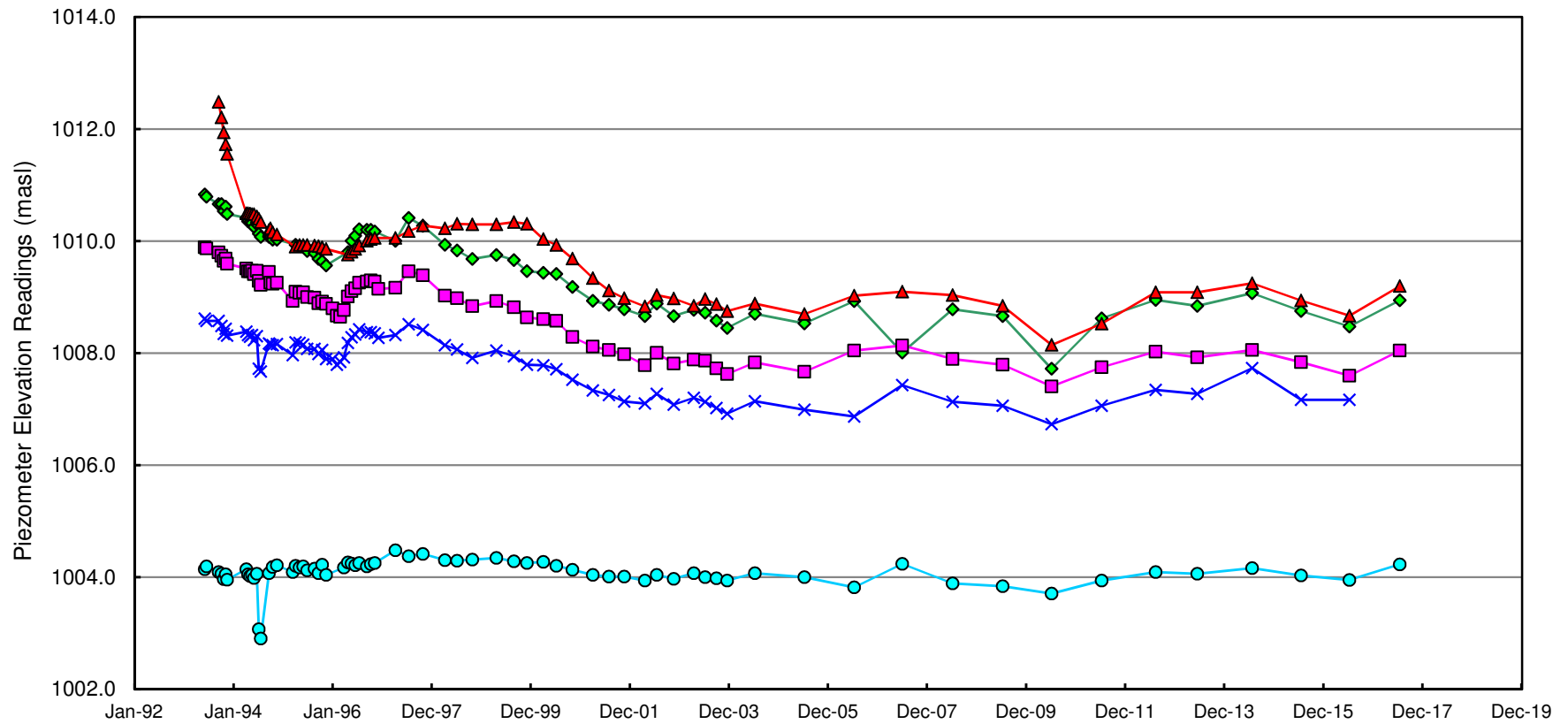

Legend = Piezo #, Ground Elev / Tip Elev

◆ P93-8 1017.2/1001.9
 ▲ P93-9,1017.2/998.8
 ■ P93-10,1017.5/1002.6
 × P93-11,1017.5/998.7
 ● P93-12,????/1000.8

Figure VIII-2 Line 33+00

Line 48+00 Piezometer Readings

Sullivan Concentrator East Gypsum Pond Dike

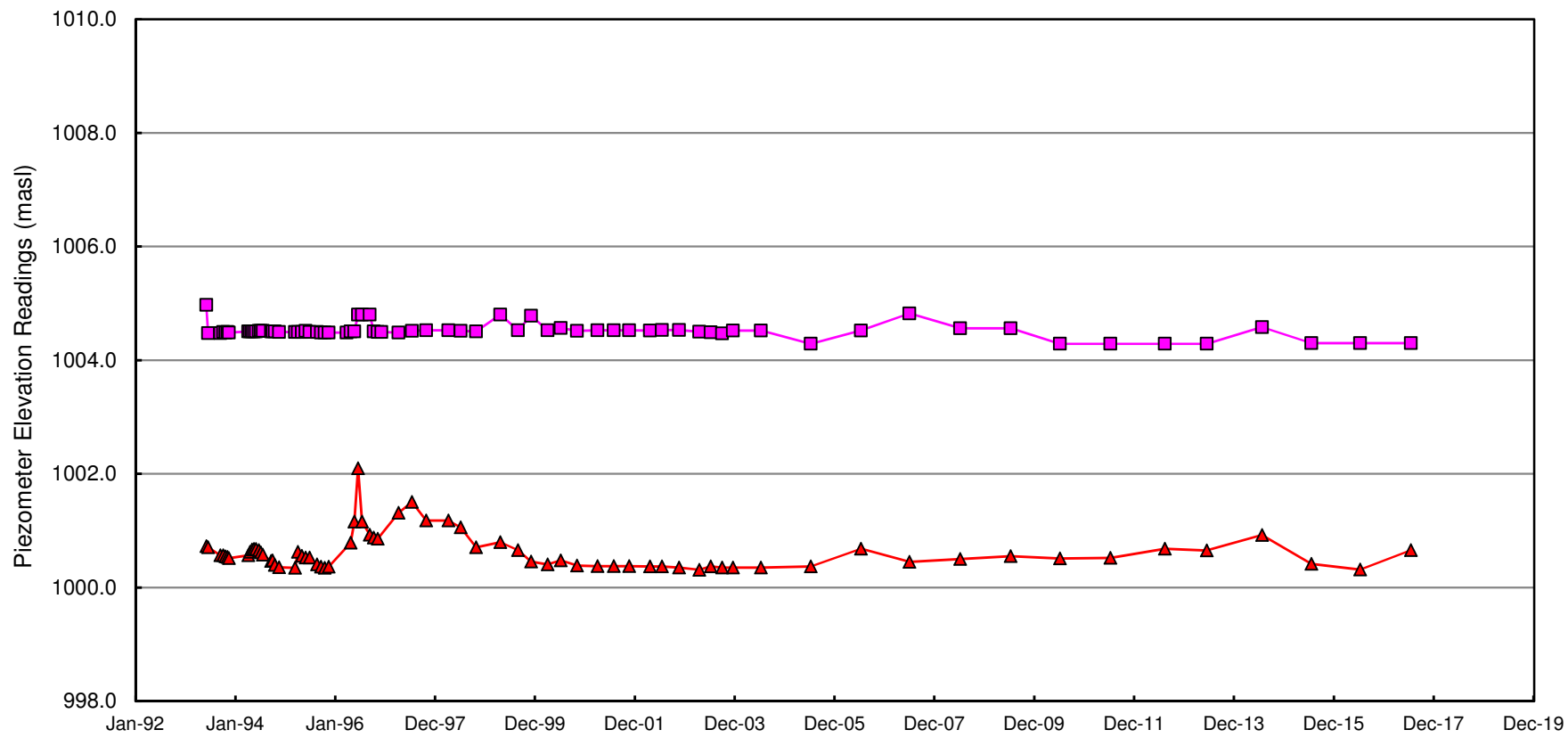

Legend = Piezo #, Ground Elev / Tip Elev



Figure VIII-3 Line 48+00

SETTLEMENT PLATES - EAST GYPSUM Dike

SP97-03 Line 33+00
SETTLEMENT PLATES - EAST GYPSUM Dike

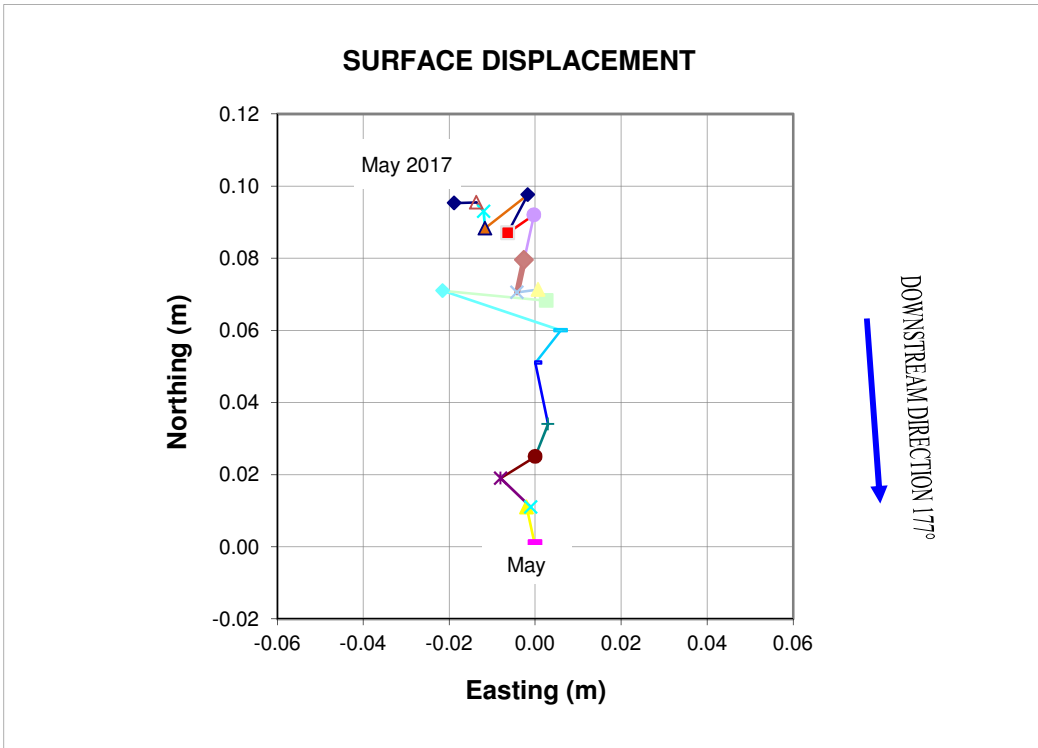
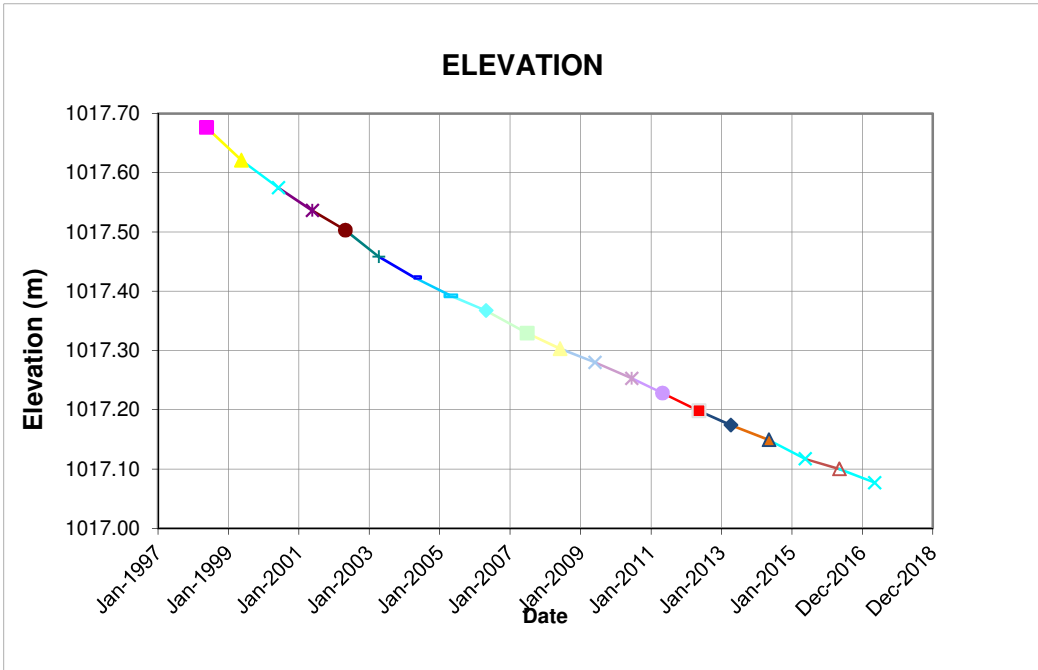

SETTLEMENT PLATES - EAST GYPSUM Dike

SP97-04 Line 48+00
 SETTLEMENT PLATES - WEST GYPSUM Dike

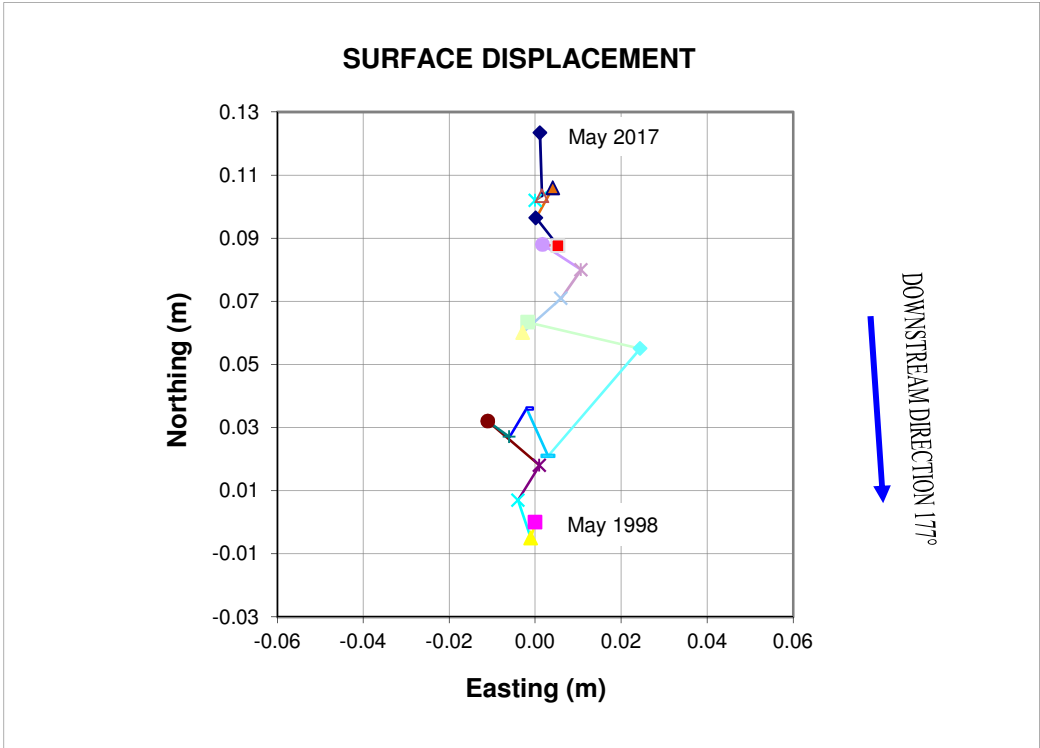
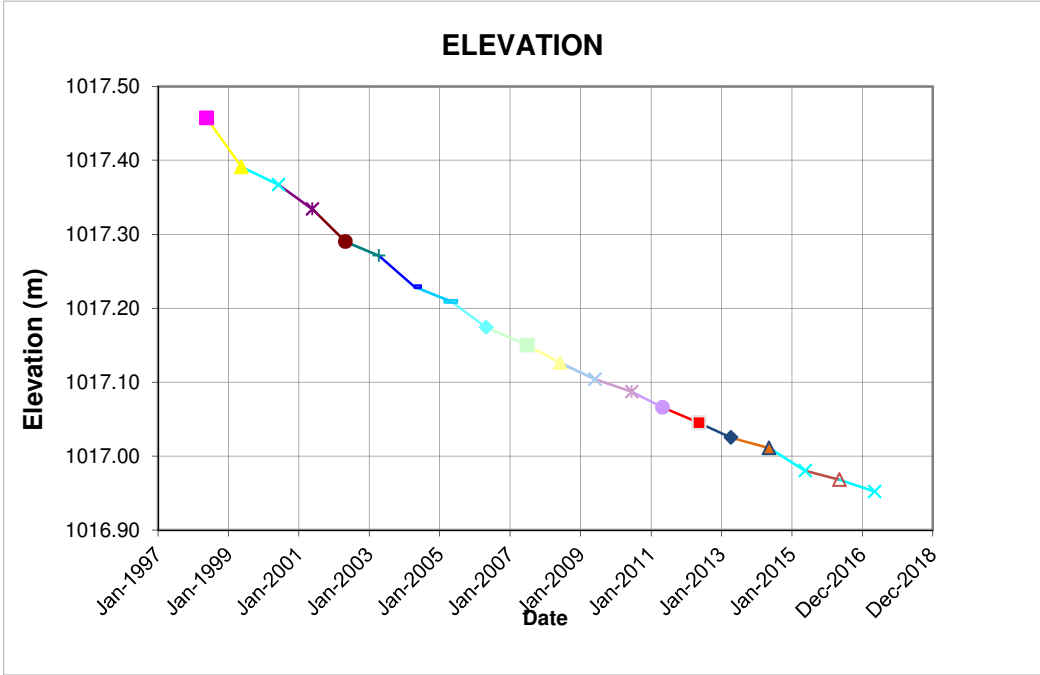

Figure VIII-5-SP97-04

APPENDIX IX

Northeast Gypsum Dike Instrumentation Data

SETTLEMENT PLATES - NE GYPSUM Dike

W Pipe
NE Gypsum Dike

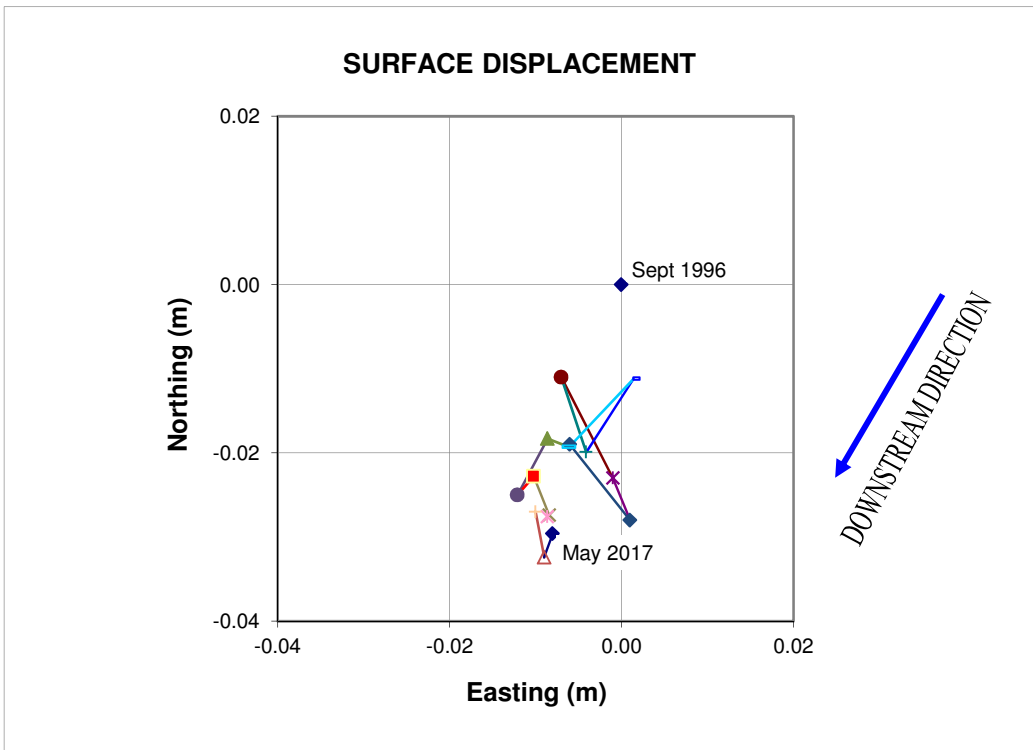
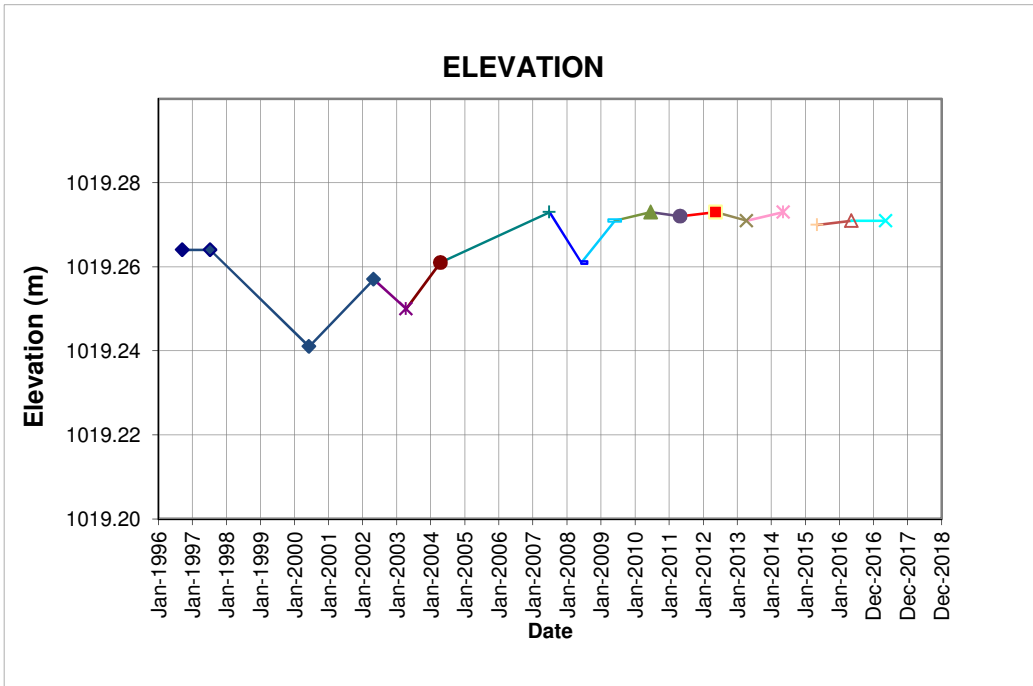

Figure IX-1 NE Gypsum Dike W pipe

SETTLEMENT PLATES - NE GYPSUM Dike

E Pipe
NE Gypsum Dike

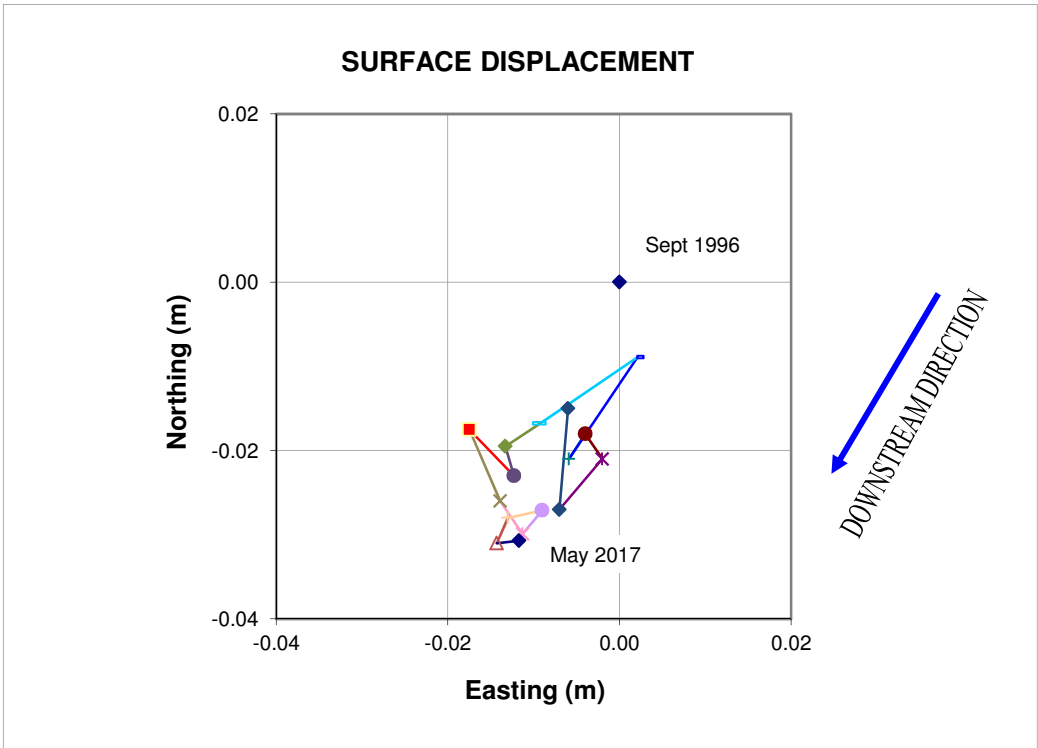
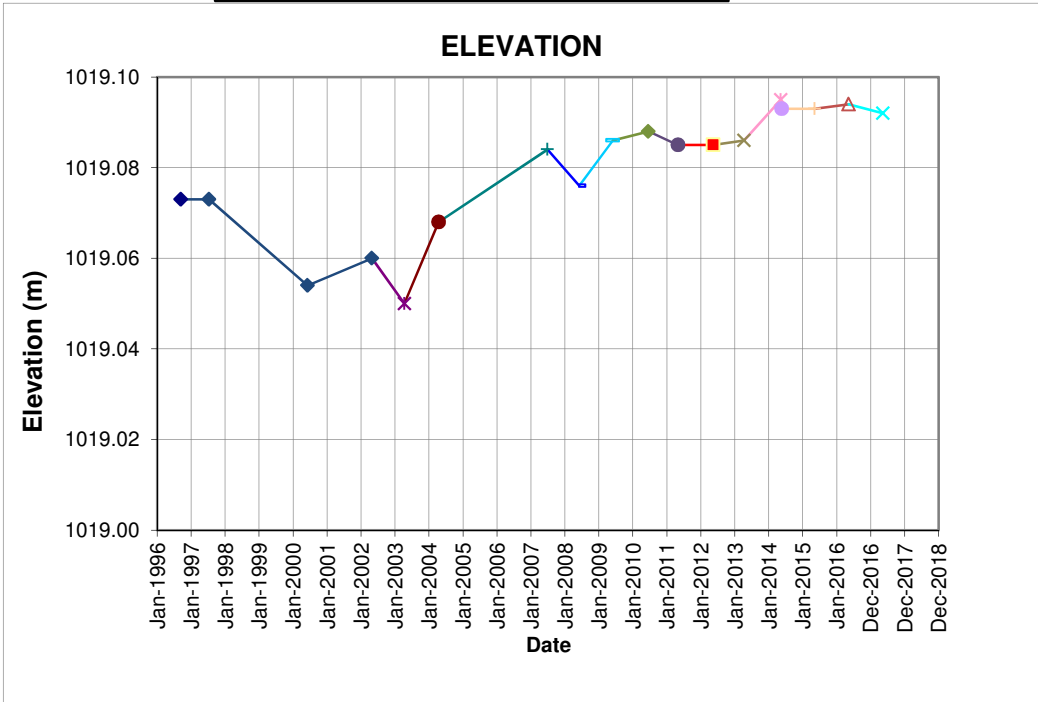

Figure IX-2 NE Gypsum Dike E pipe

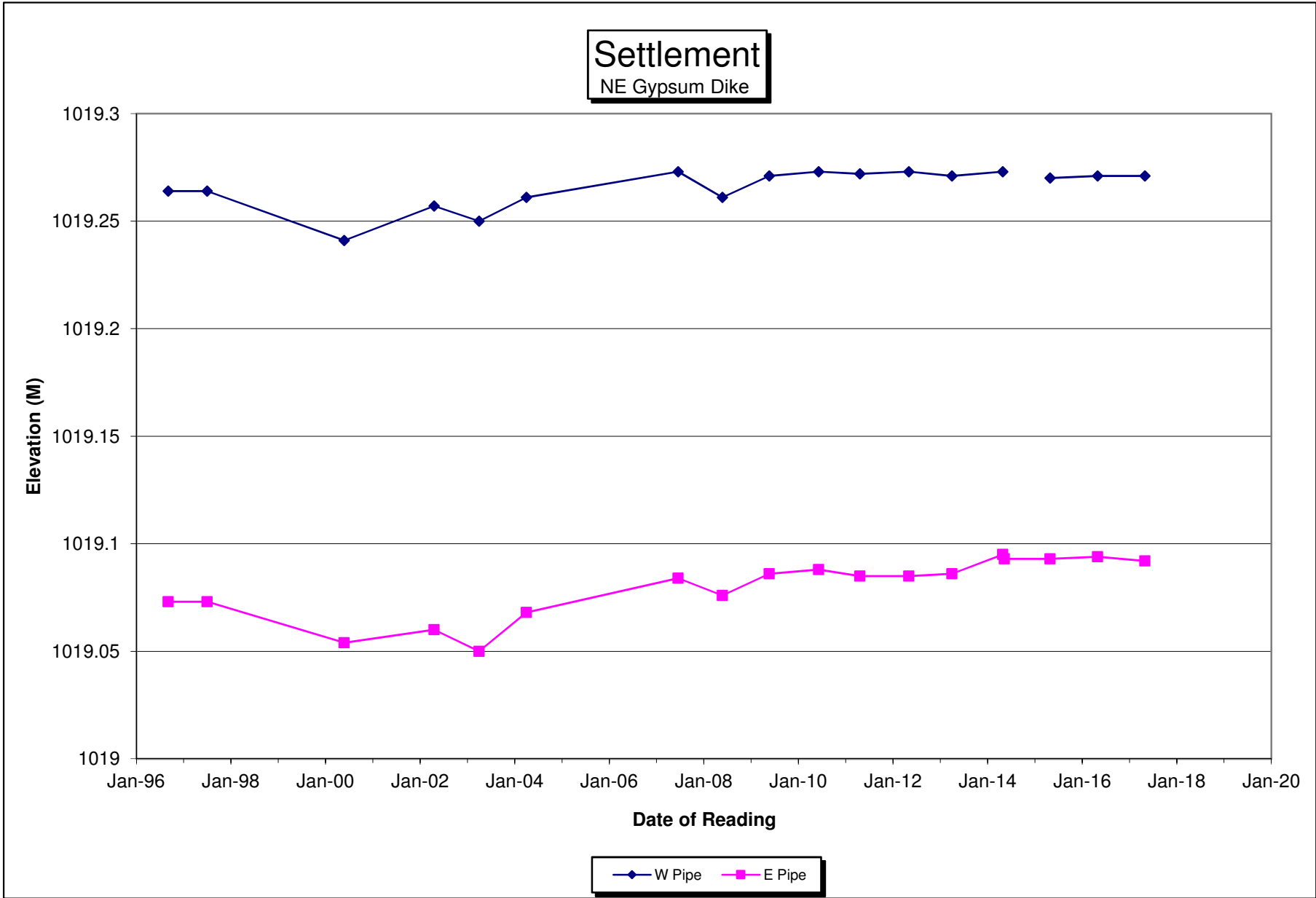

Figure IX-3

APPENDIX X

ARD Pond - South Dam and North Dam Instrumentation Data

SOUTH DAM PIEZOMETERS

ARD STORAGE POND

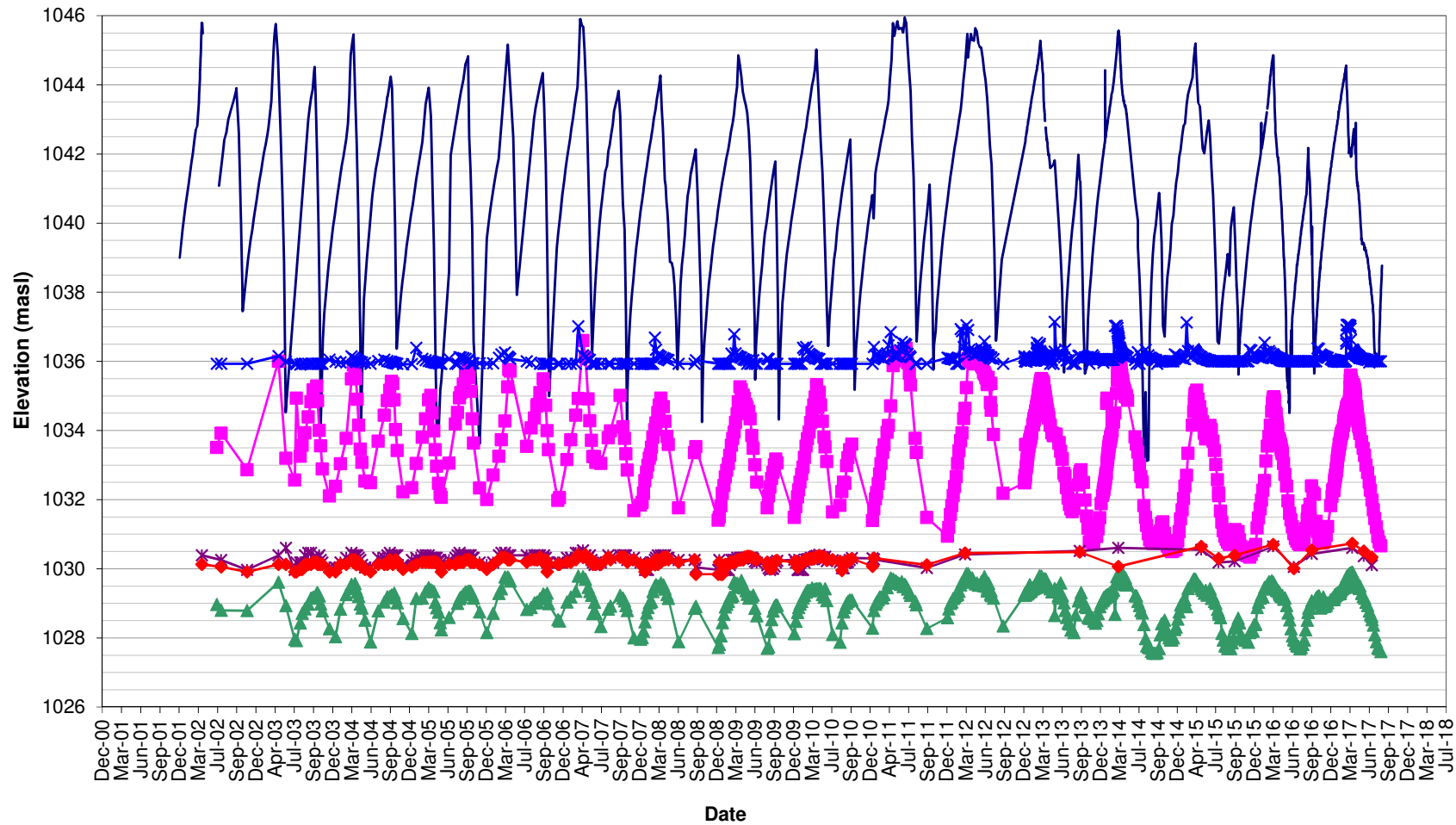

Legend = Piezo #, Ground Elev / Tip Elev



Figure X-1 SOUTH DAM

SOUTH DAM PIEZOMETERS vs. POND LEVEL

ARD STORAGE POND

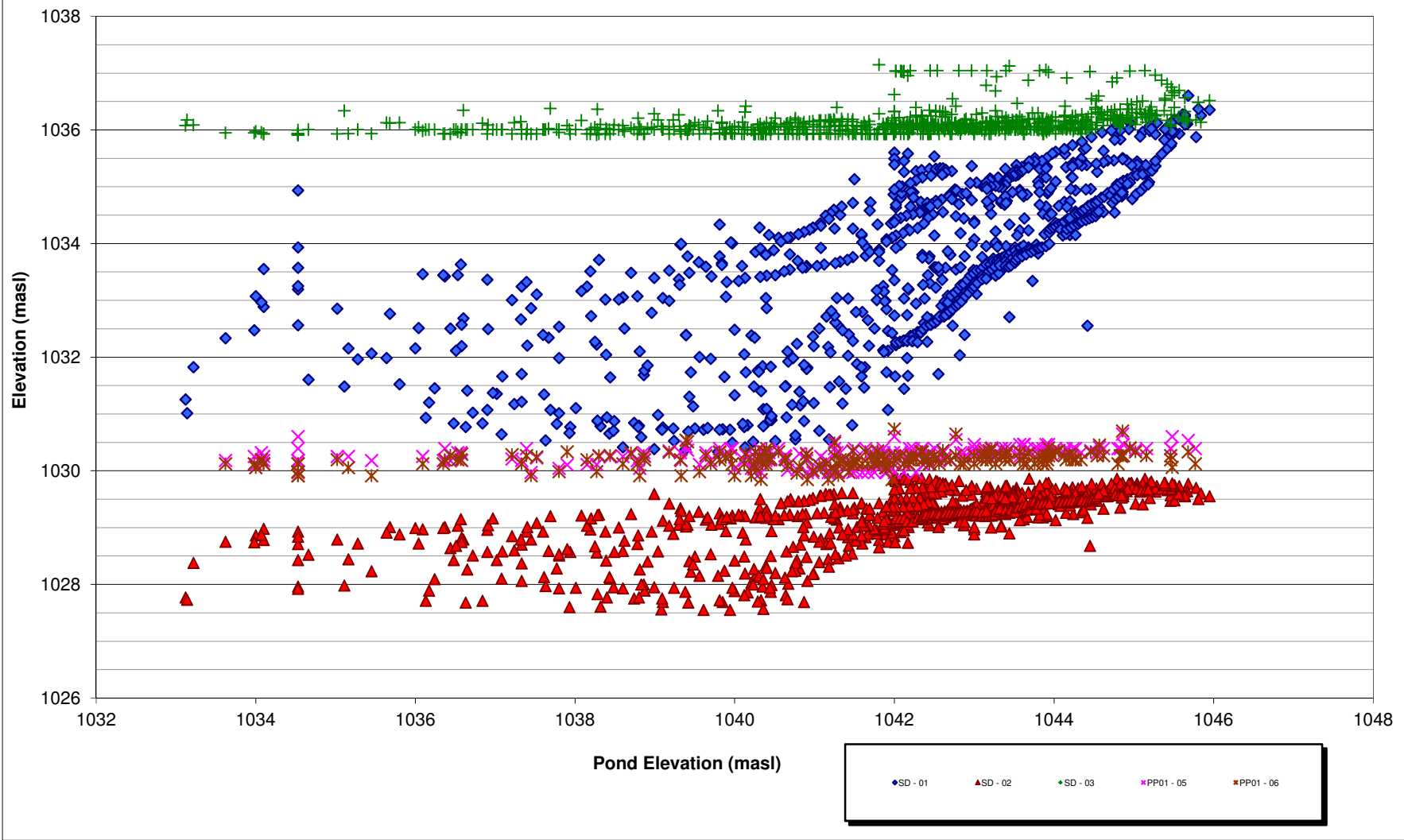
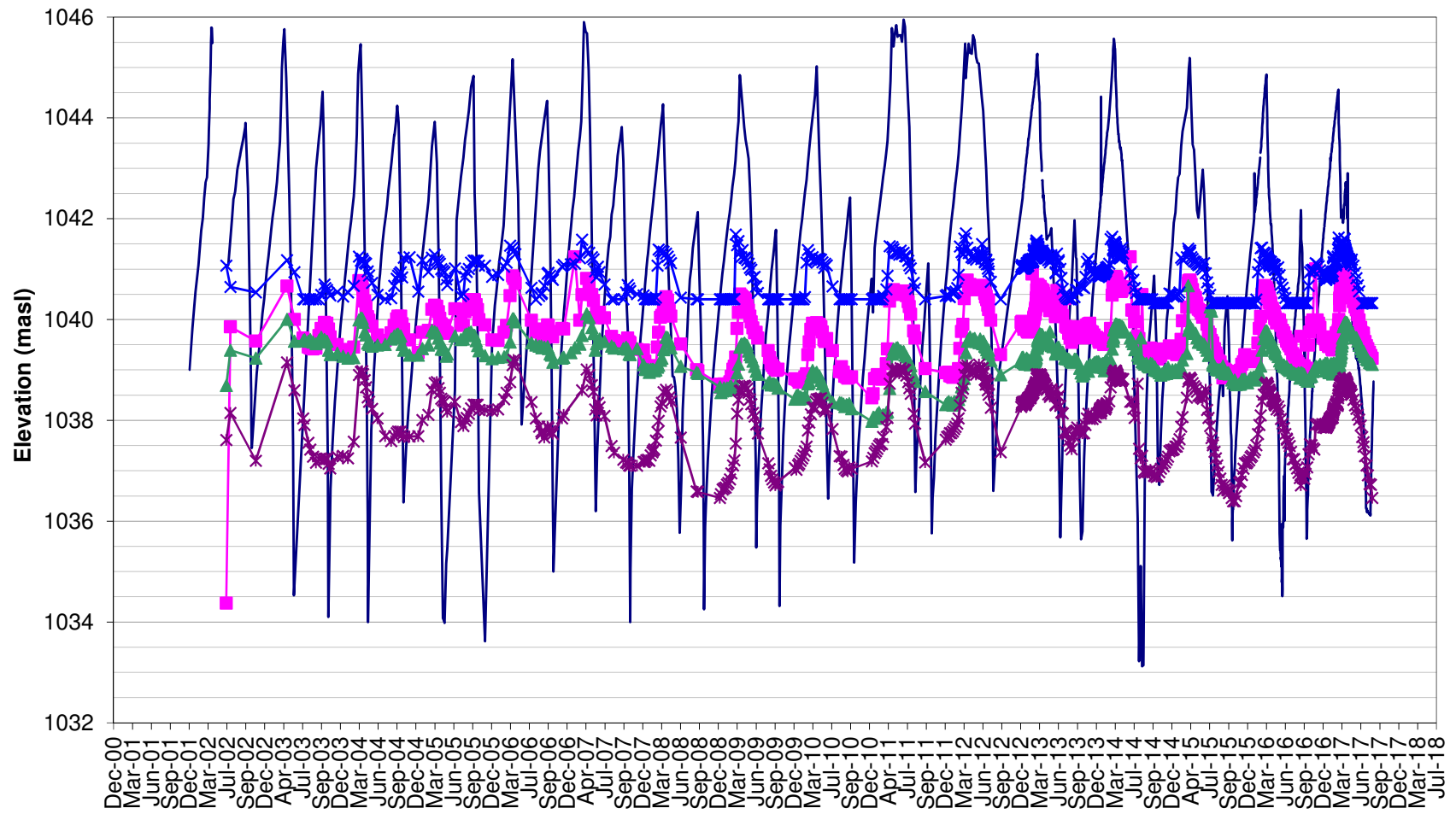

Figure X-2 SOUTH DAM piezo vs pond level

NORTH DAM STANDPIPE PIEZOMETERS

ARD STORAGE POND



Legend = Piezo #, Ground Elev / Tip Elev

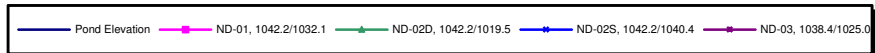

Figure X-3 NORTH DAM STANDPIPES

NORTH DAM PNEUMATIC PIEZOMETERS

ARD STORAGE POND

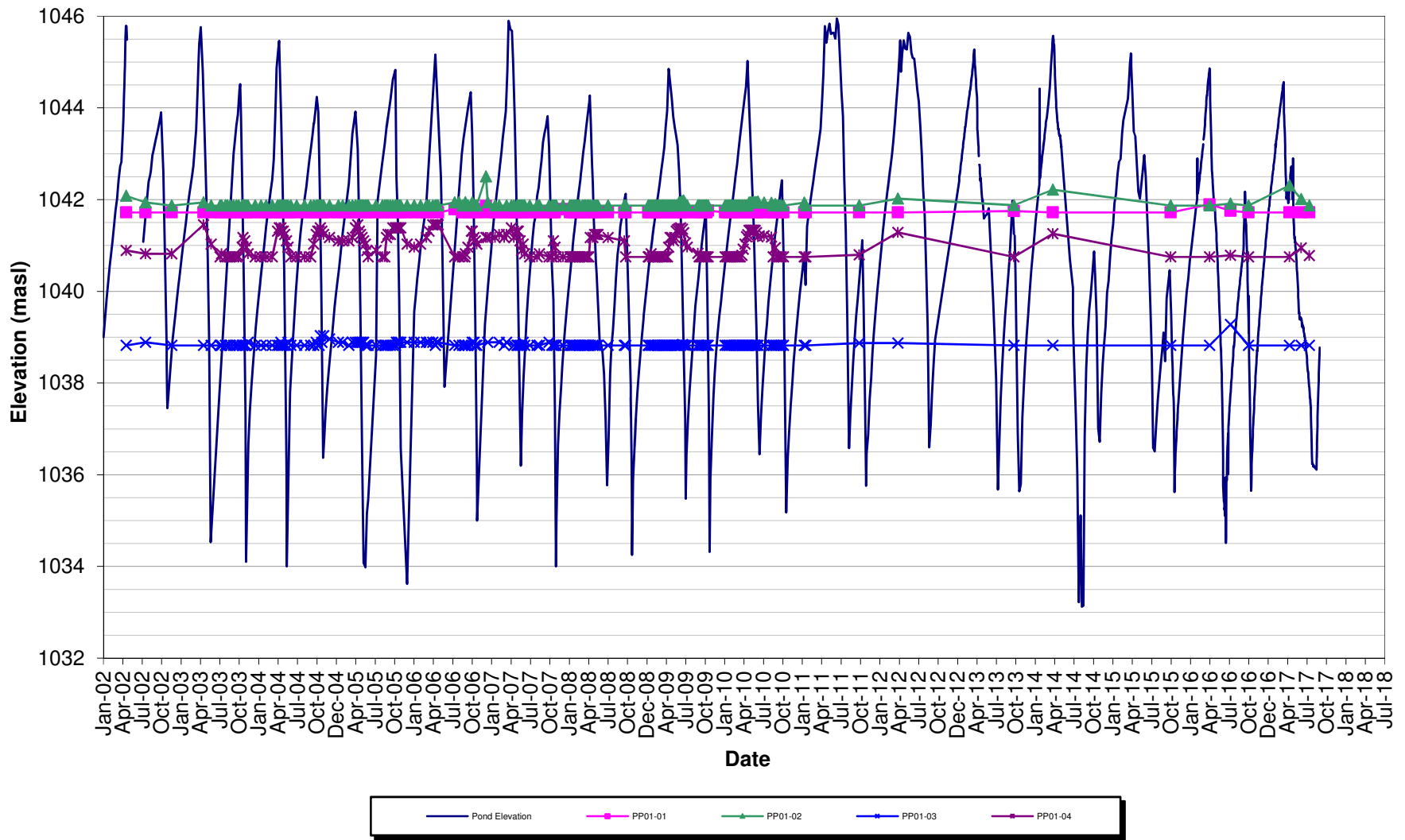

Figure X-4 NORTH DAM PNEUMATICS

SOUTH DAM WEIR #1 (ARDWU) FLOWS

ARD POND

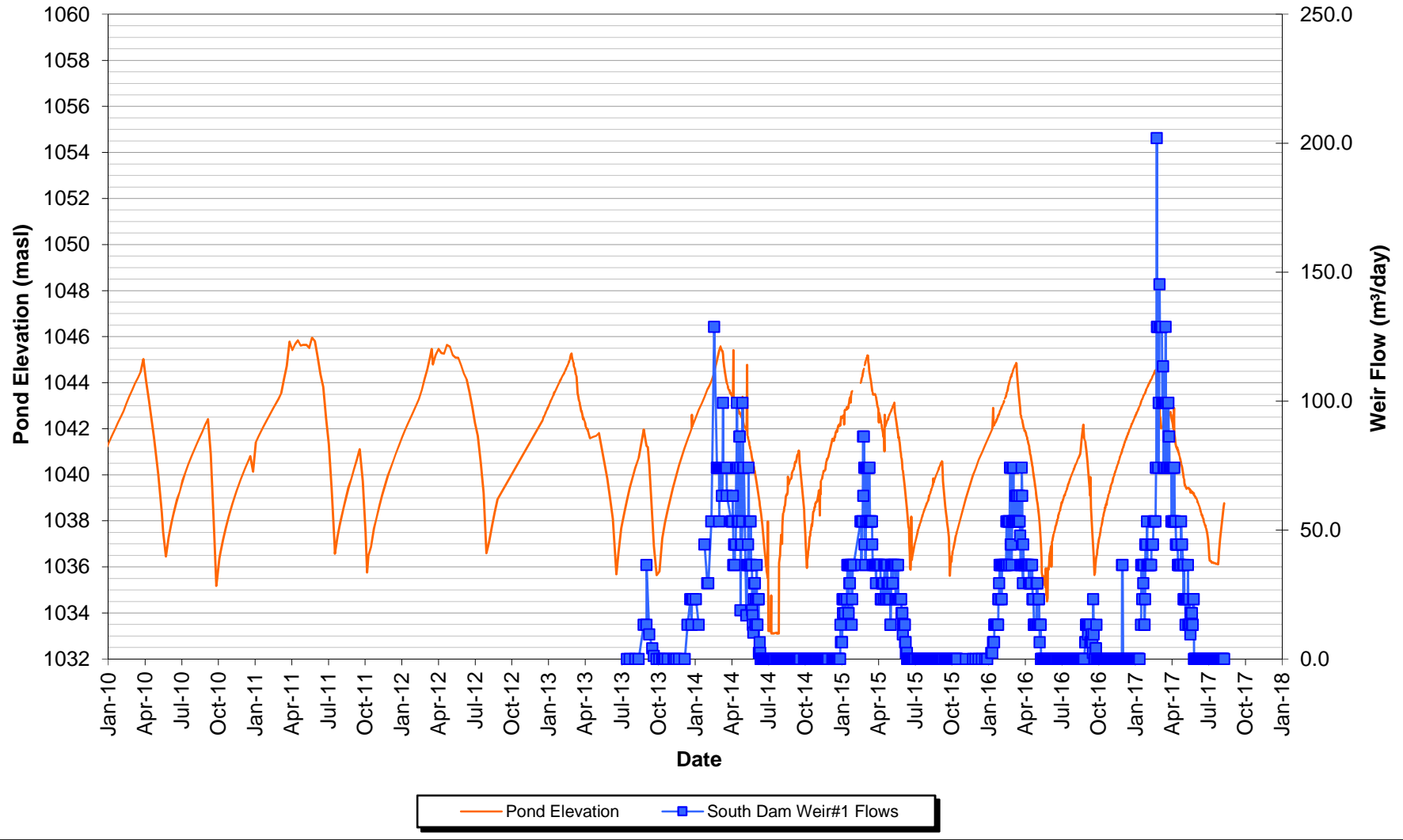

Figure X-5 ARD Weir #1 (ARDWU) time plot

SOUTH DAM WEIR #2 FLOWS

ARD POND

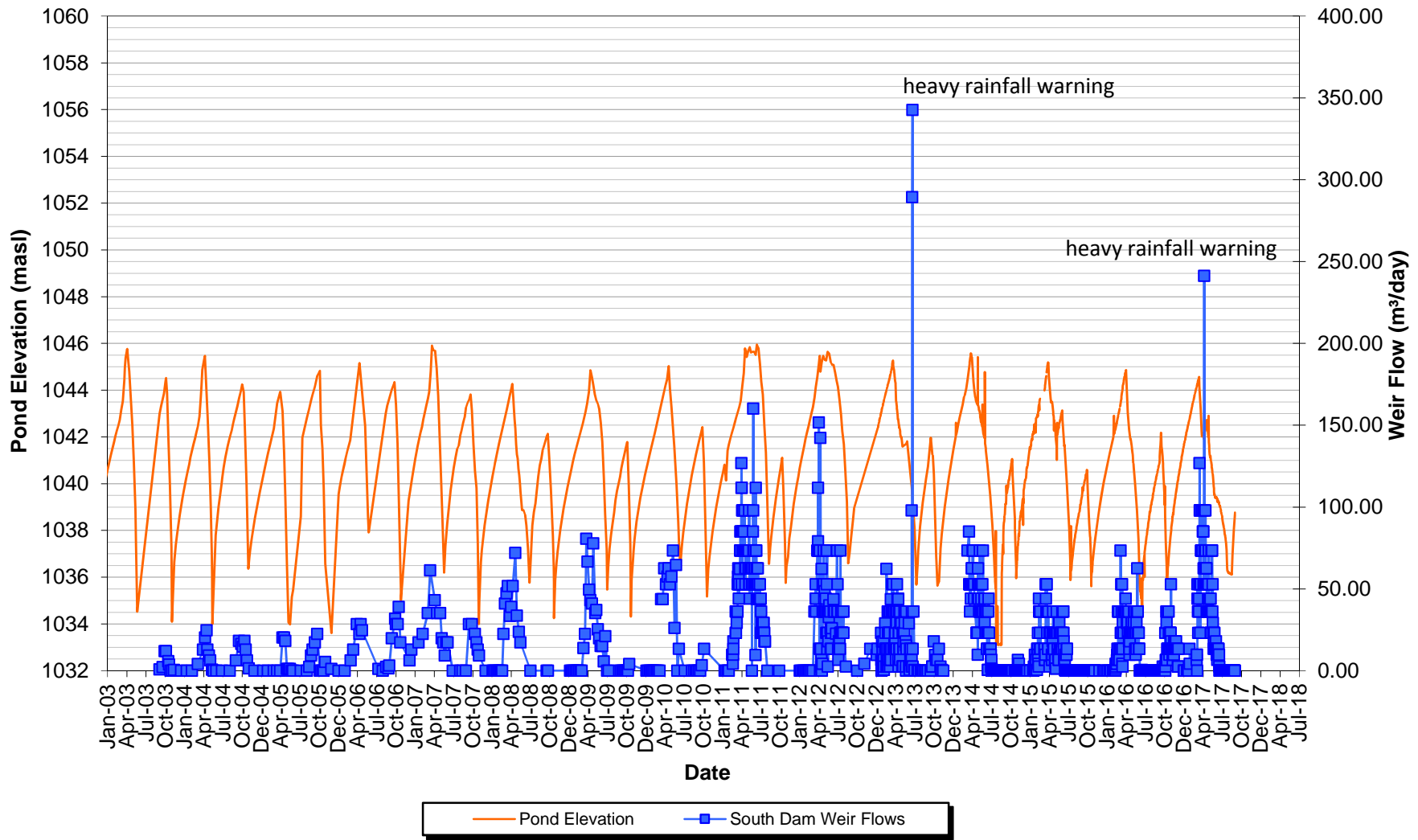

Figure X-6 ARD Weir #2 time plot

South Dam Settlement Plates

ARD Pond

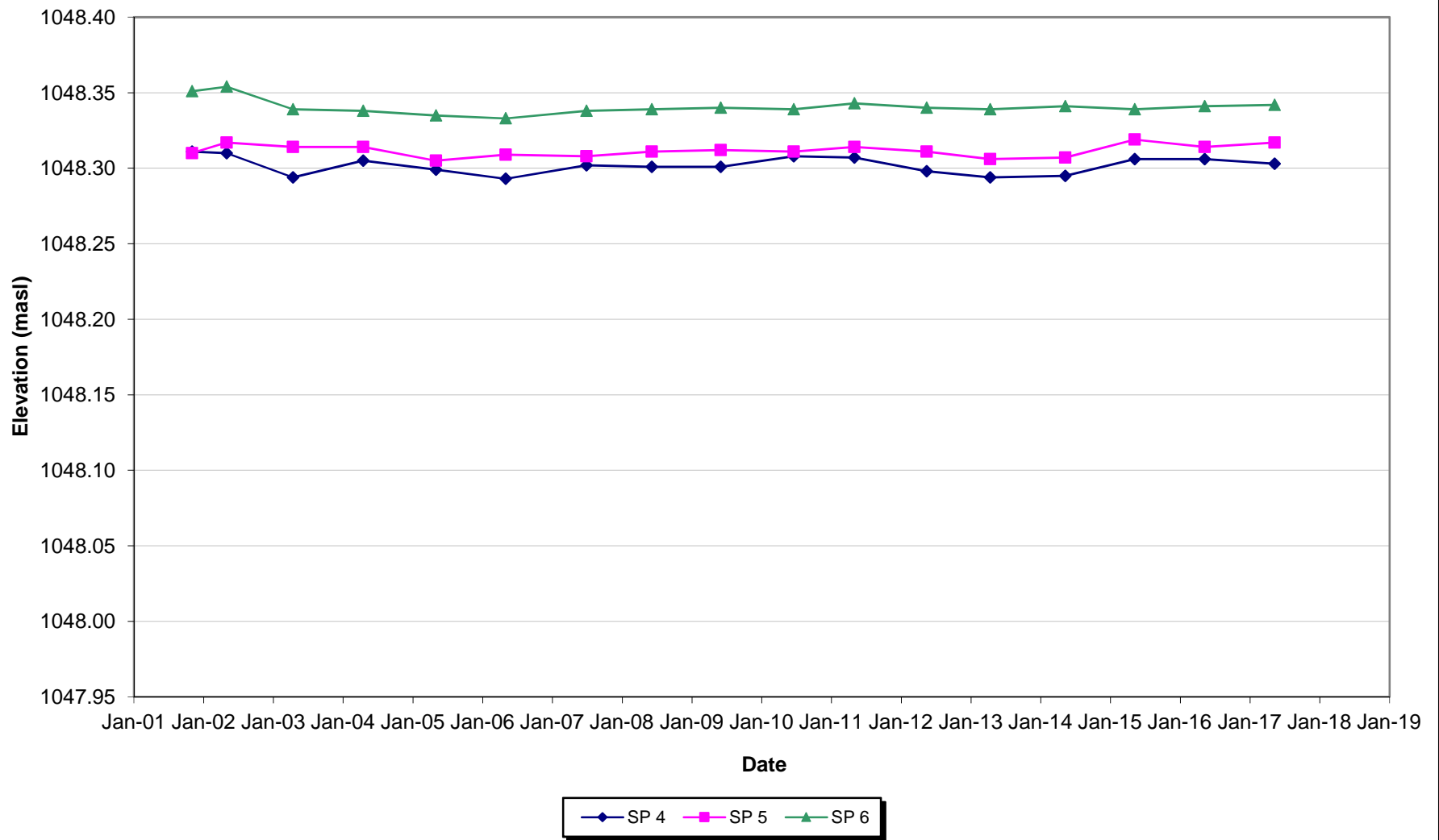

Figure X-7 SD Settlement

North Dam Settlement Plates

ARD Pond

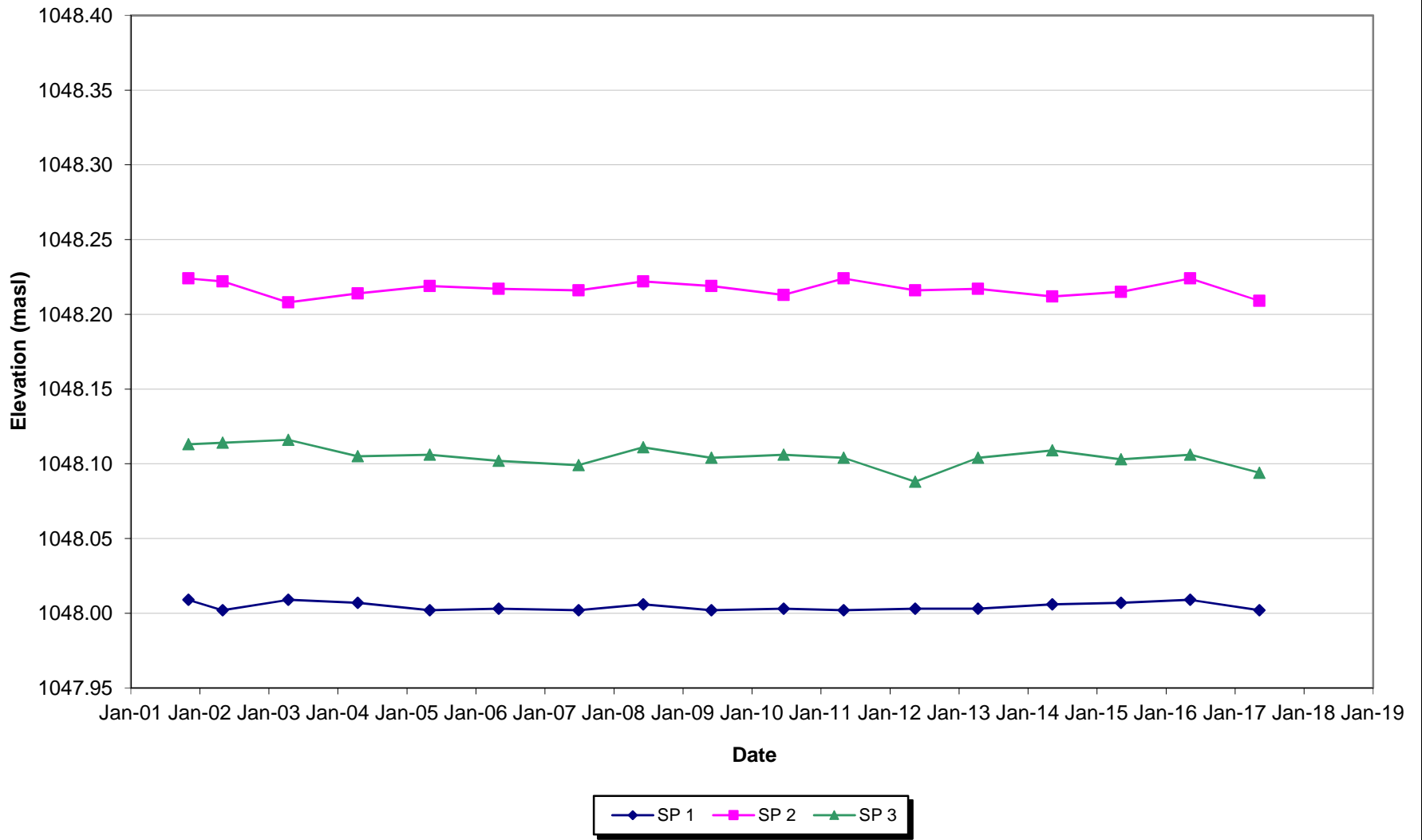

Figure X-8 ND Settlement

APPENDIX XI

Sludge Pond Dike Crest Survey

APPENDIX XII

Summary of Climate and Water Balance Data



Figure XII-1 Precipitation Records in the Site Area

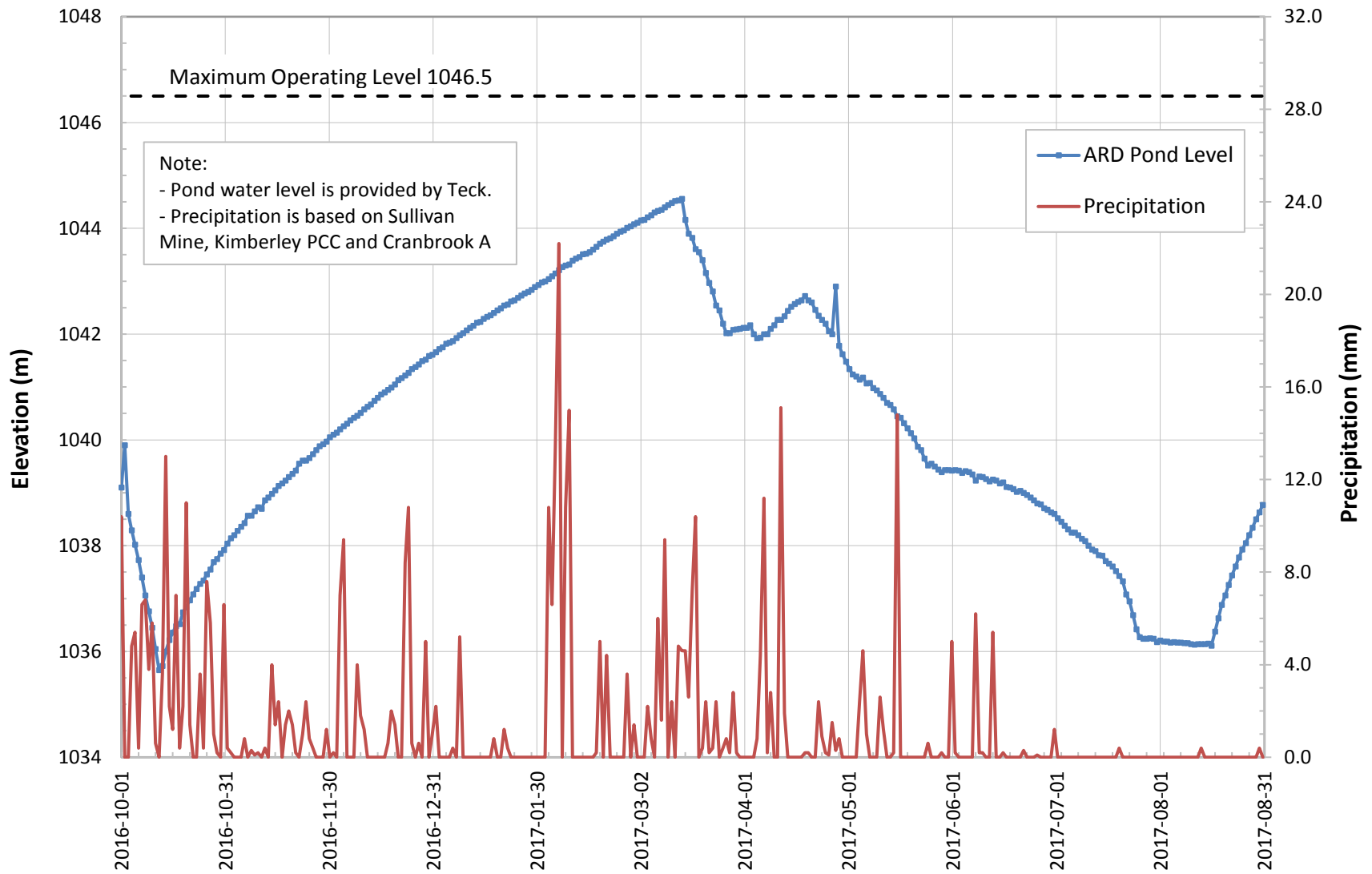

Figure XII-2 ARD Pond: Water Level and Precipitation

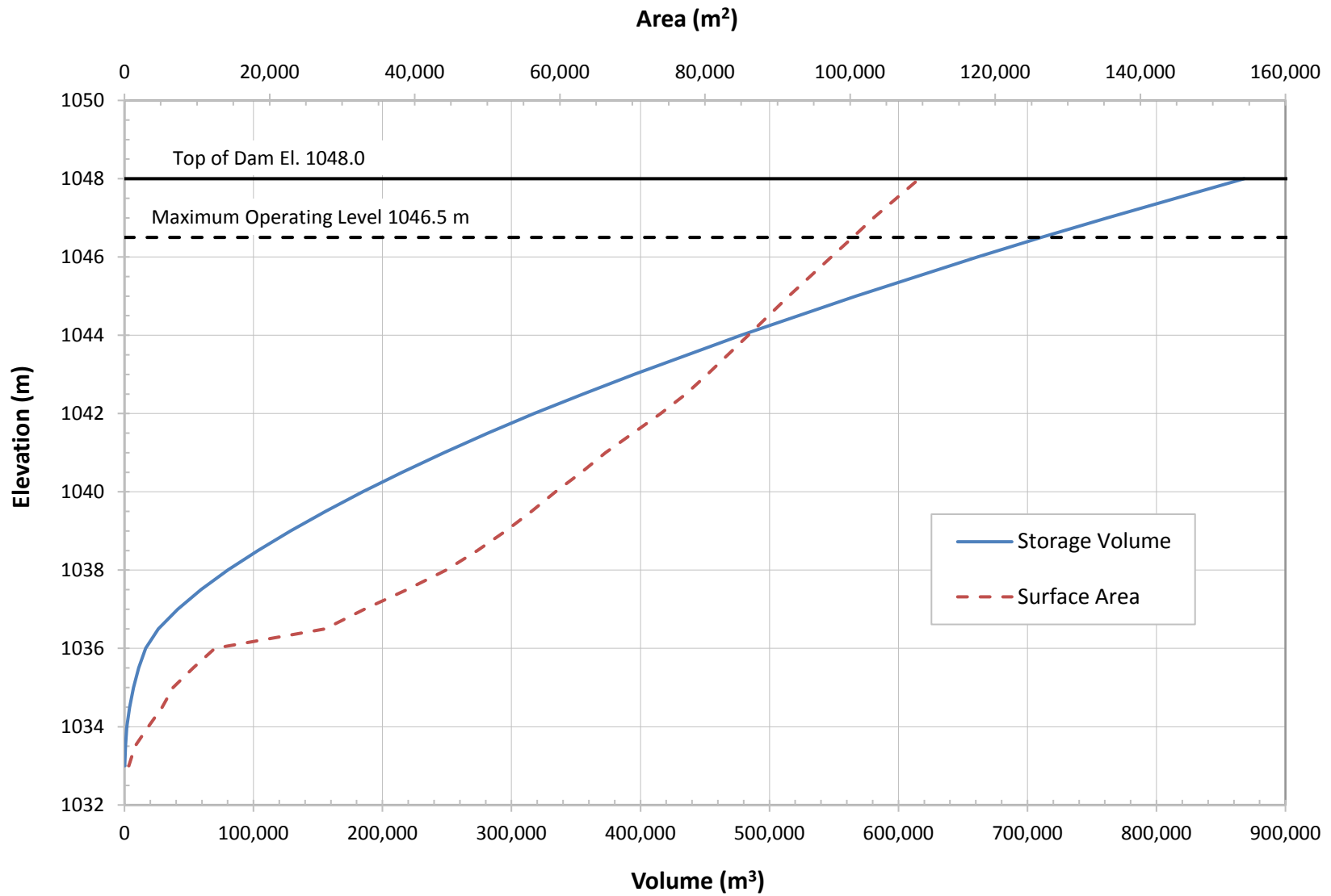

Figure XII-3 ARD Storage Pond: Area - Volume Curve

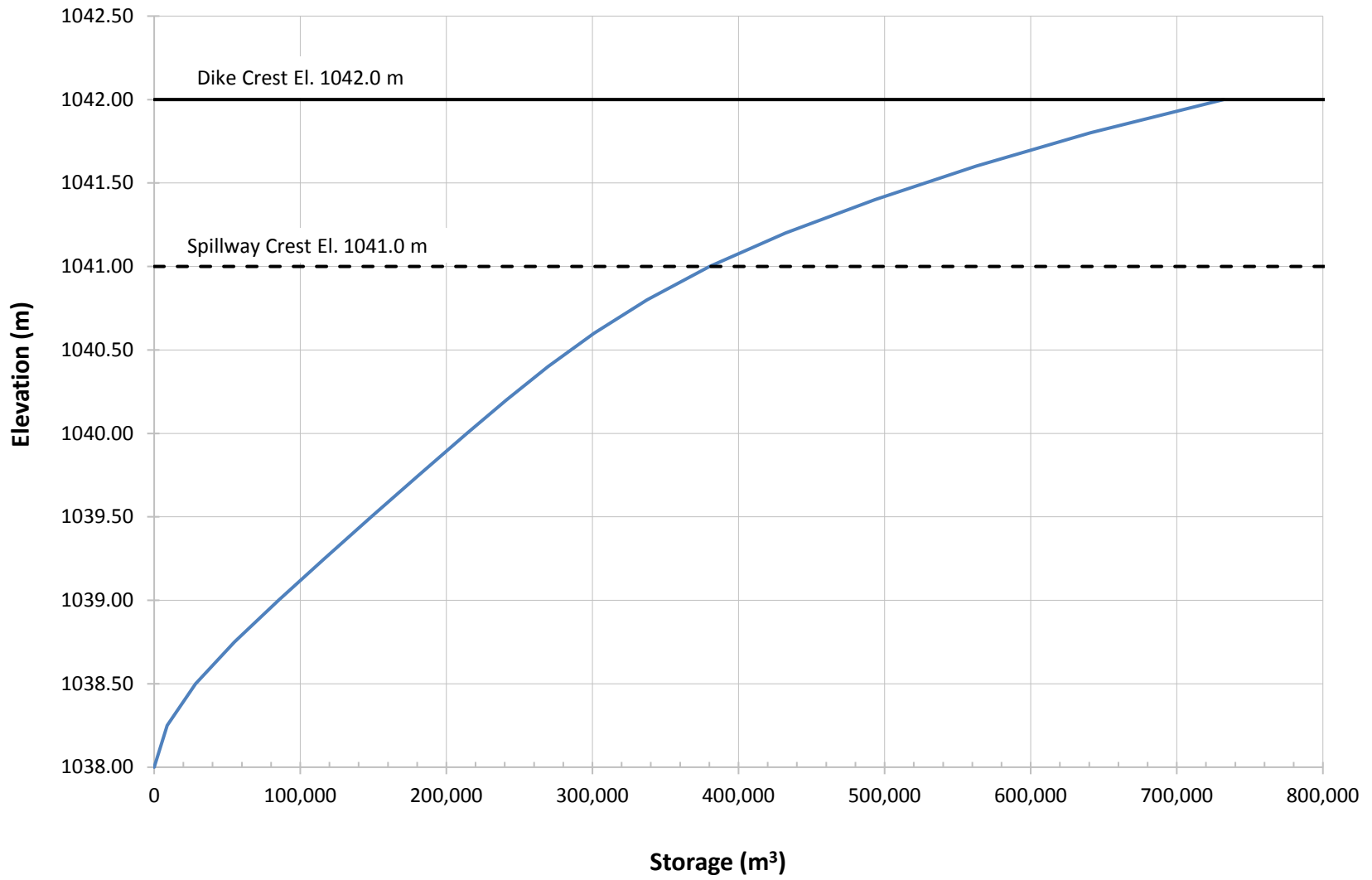

Figure XII-4 Emergency Storage Pond: Stage - Storage Curve

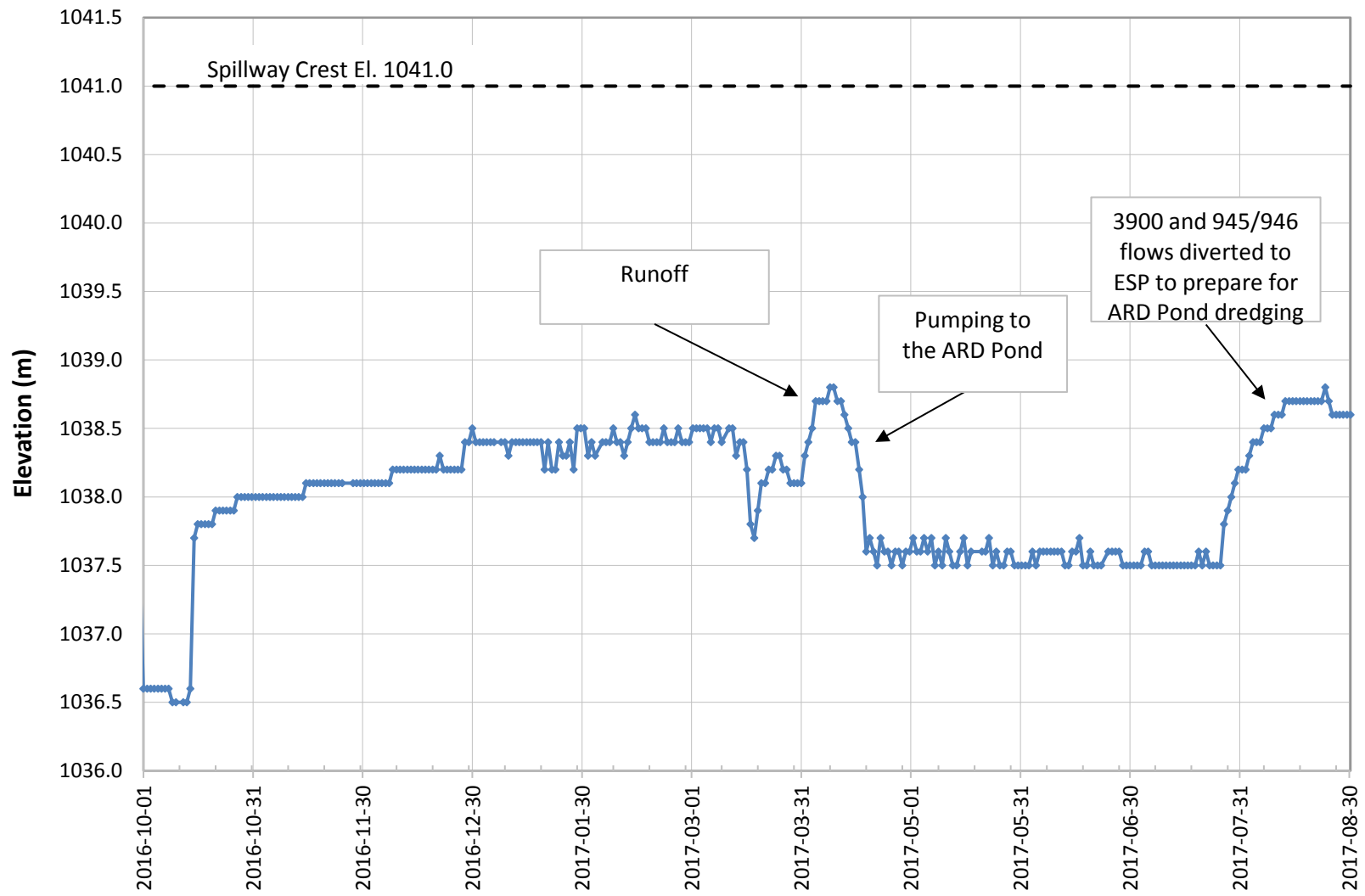

Figure XII-5 Emergency Storage Pond: Water Level Records